

**THE 1998 GUIDE
TO THE
ENGINES AND CARS
OF
AMTRAK**

RTL TURBO POWER COACH

Eqpt Code: TC

125 MPH

Car Numbers: 150-152-154-156-158-160-162

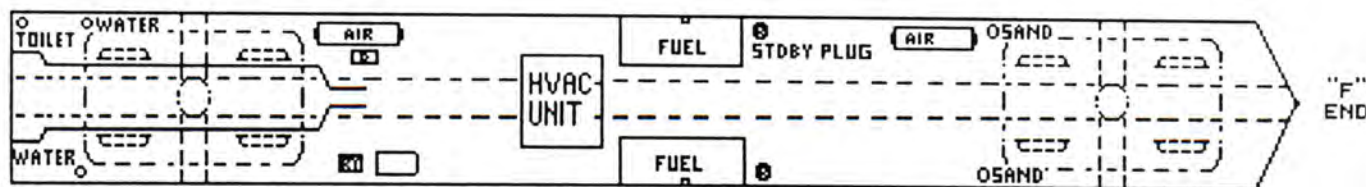
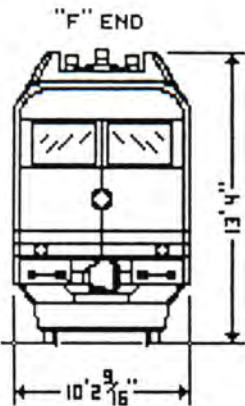
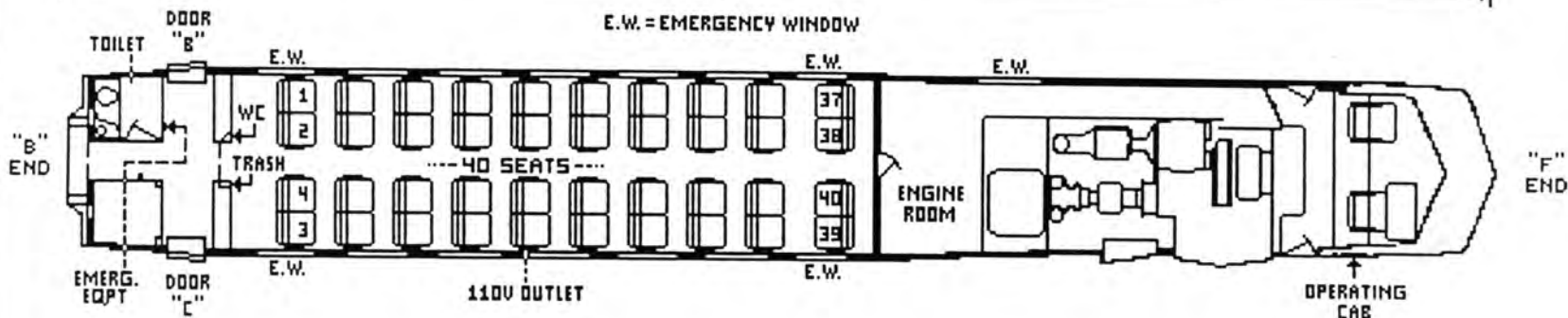
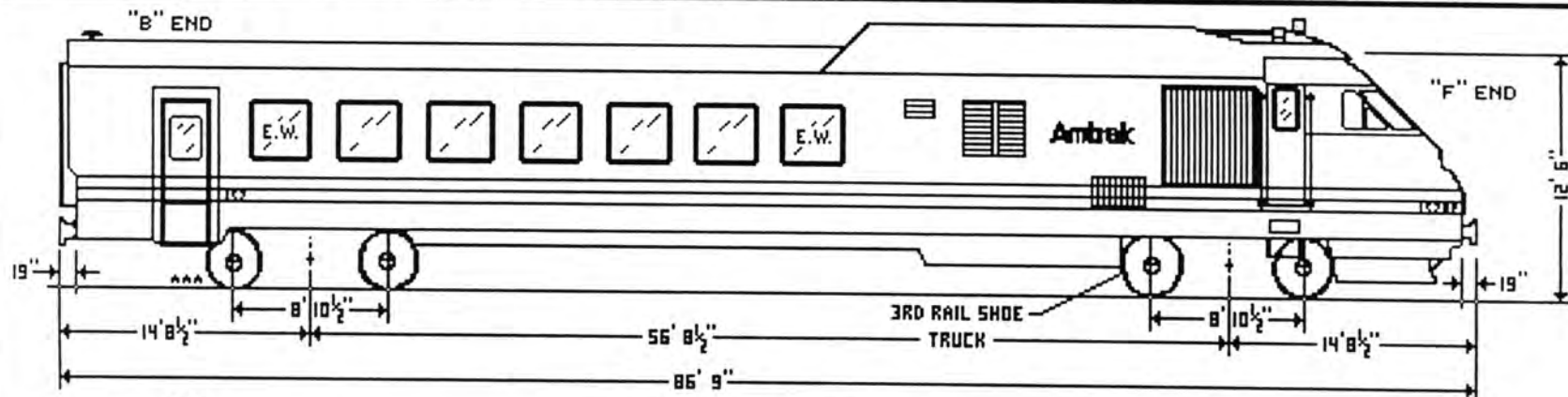

SEATS: 40

RTL TURBO POWER CLUB (CUSTOM CLASS)

Eqpt. Code: TP

125 MPH

Car Numbers: 151, 159

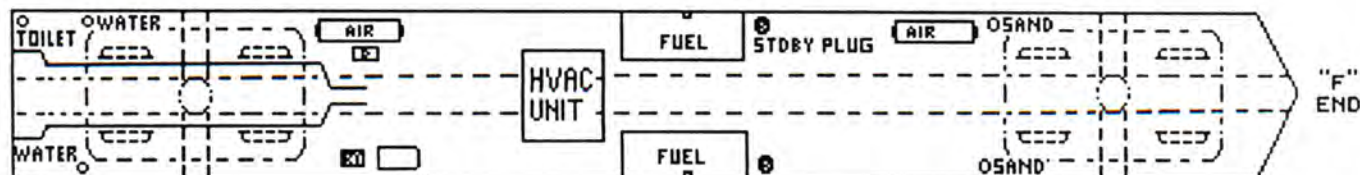
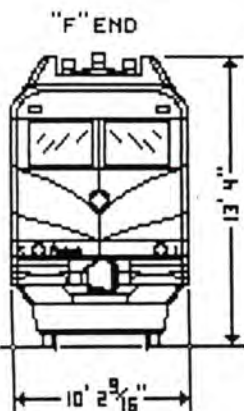
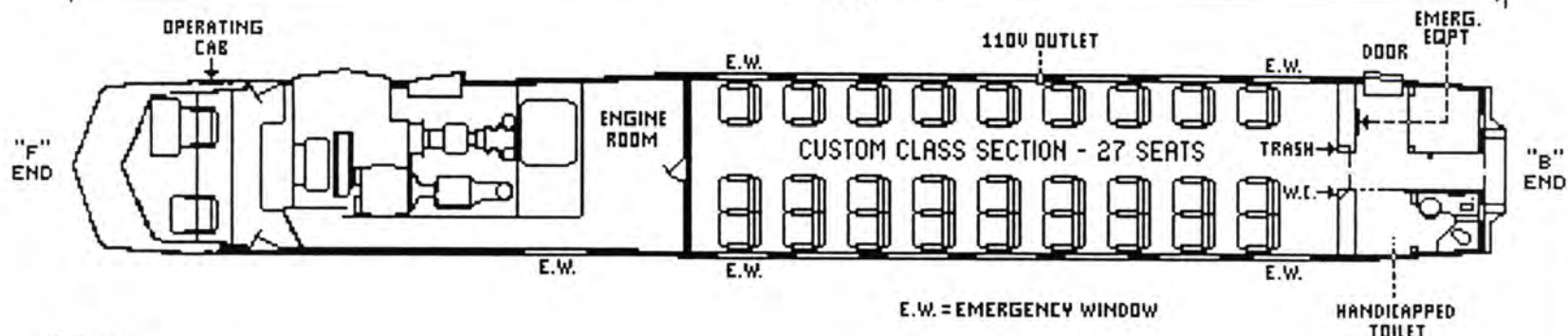
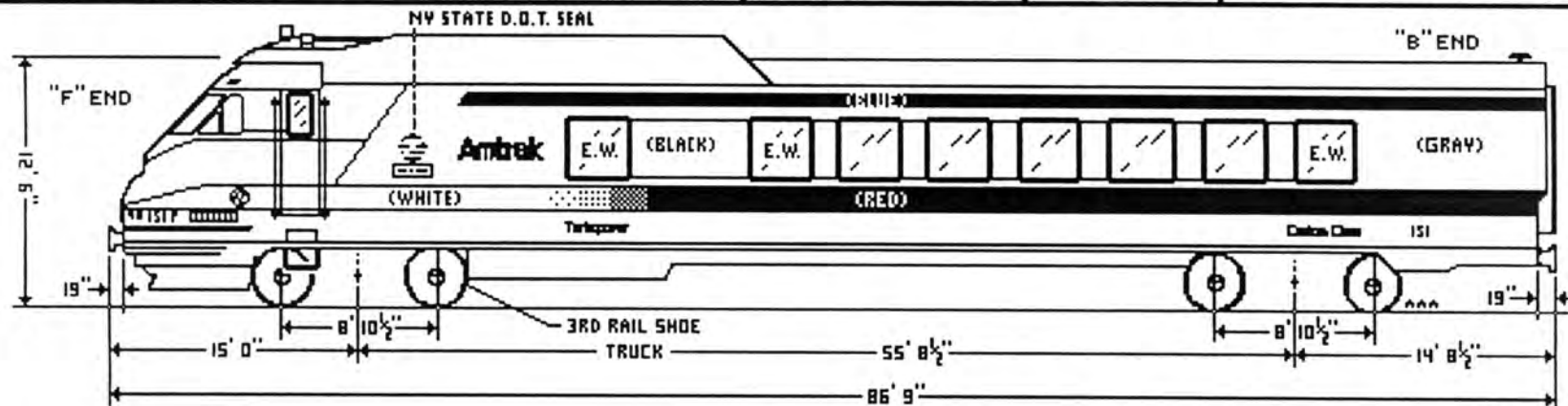

UNDERBODY VIEW THROUGH FLOOR

N.Y. STATE HIGH-SPEED TURBO SET

SEATS: 27

RTL TURBO POWER CLUB (CUSTOM CLASS) Eqt Code: TP 125 MPH Car Nos: 153-155-157-161-163

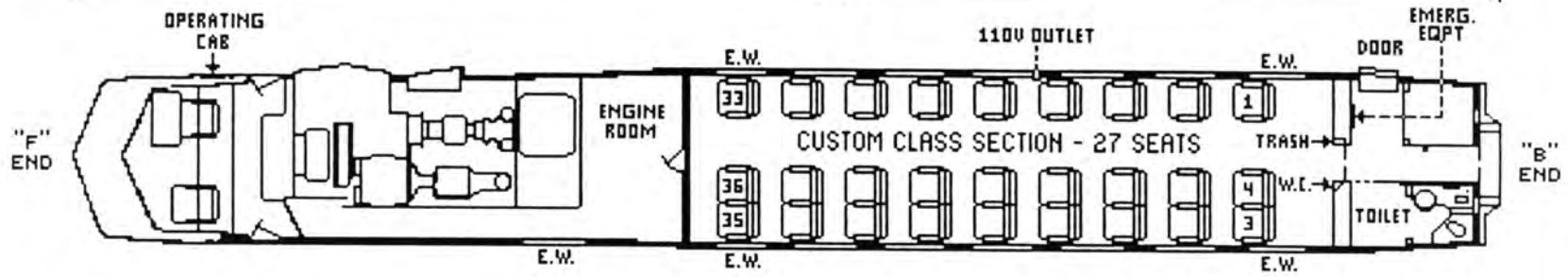
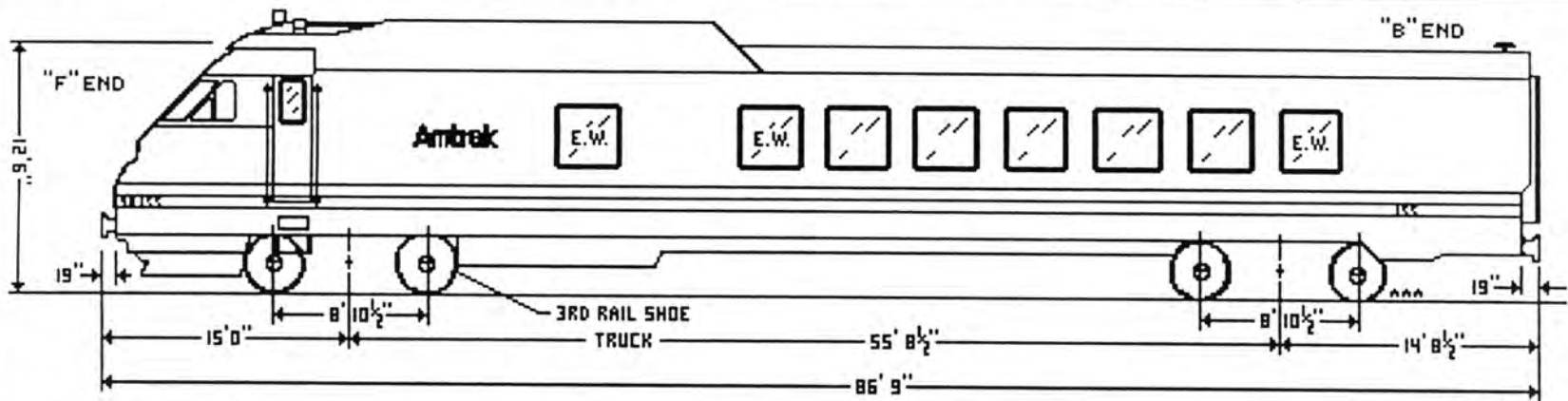

E.W. = EMERGENCY WINDOW

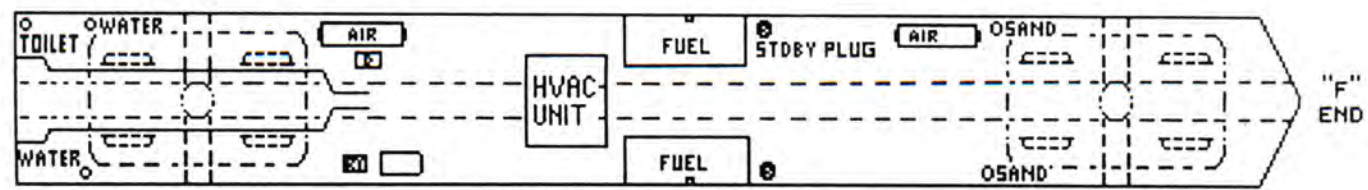
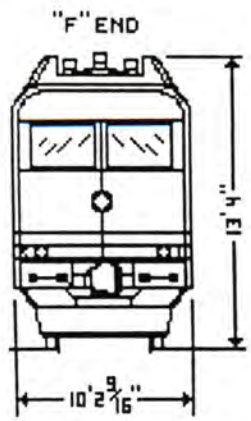

UNDERBODY VIEW THROUGH FLOOR

SEATS: 27

RTL TURBO COACH

Eqpt Code: TS

125 MPH

Car Nos: 170-172-173-175-176-178-182-184-185-187-188-190

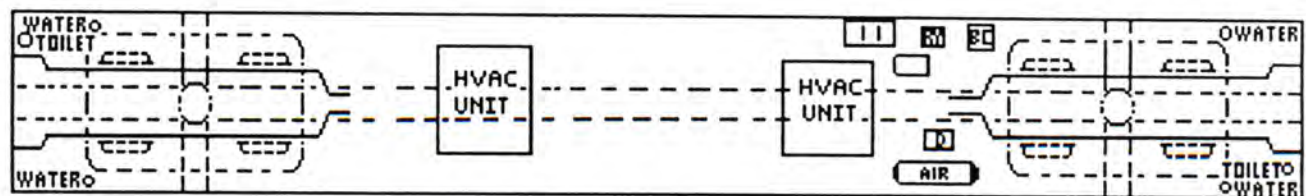
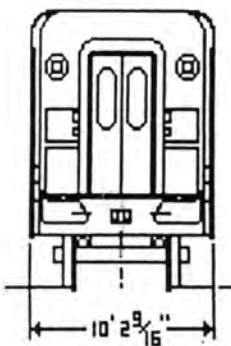
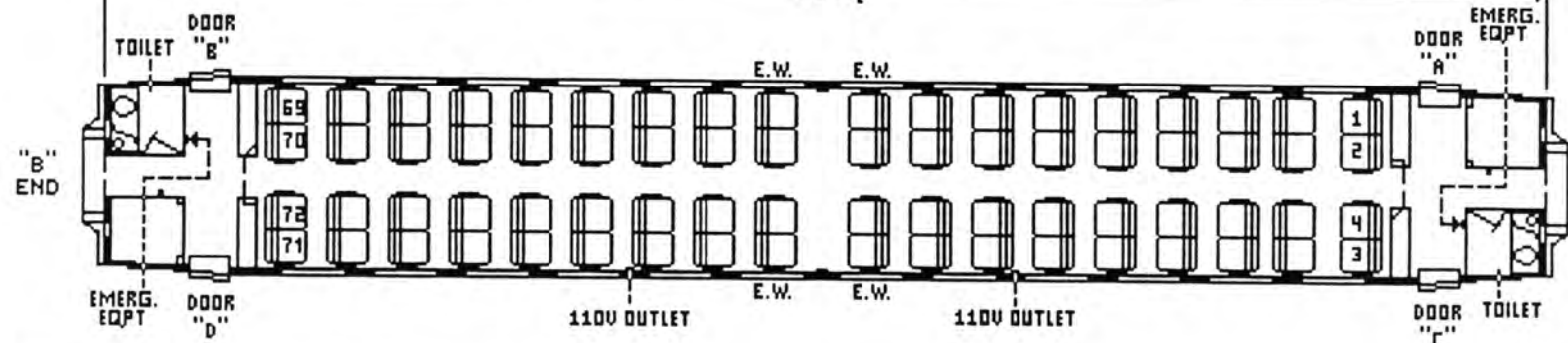
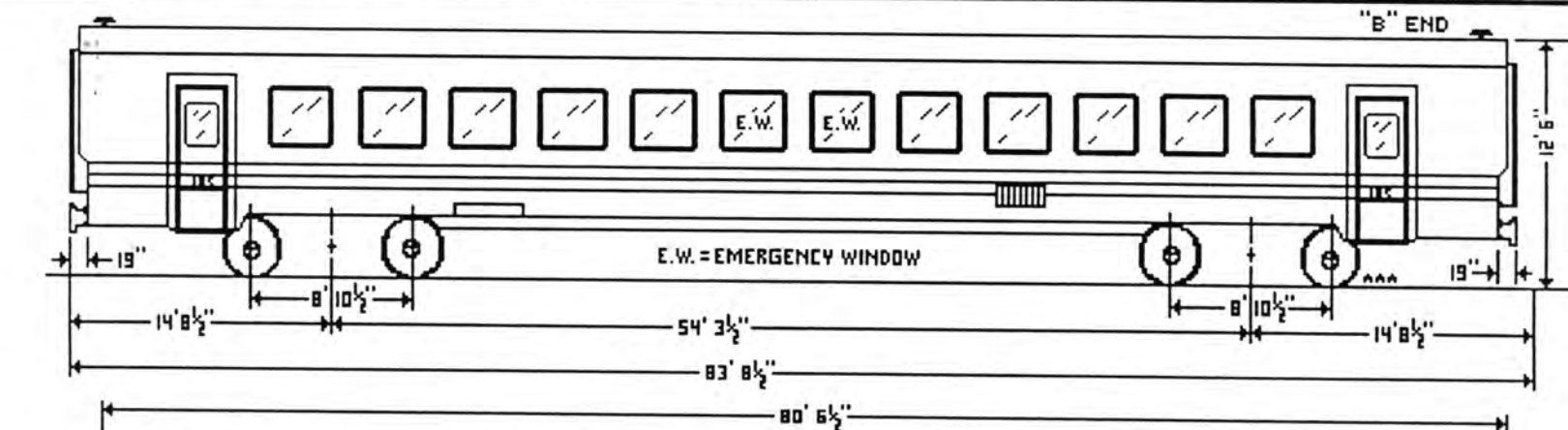

UNDERBODY VIEW THROUGH FLOOR

SEATS: 72

RTL TURBO CAFE

Equipment Code: TF

125 MPH

Car Numbers: 171-174-177-183-186-189

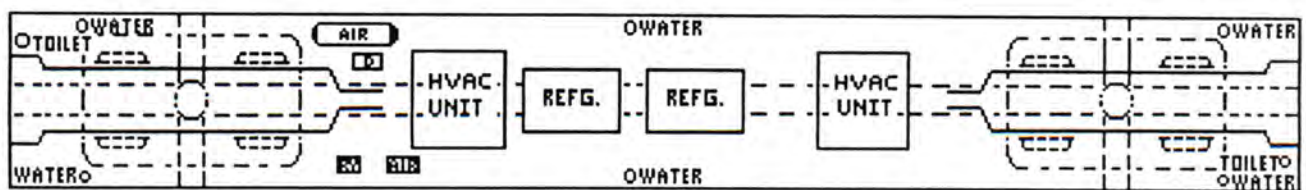
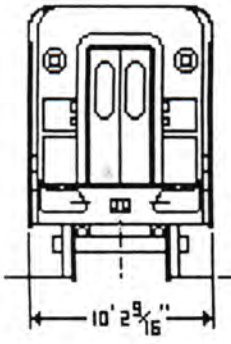
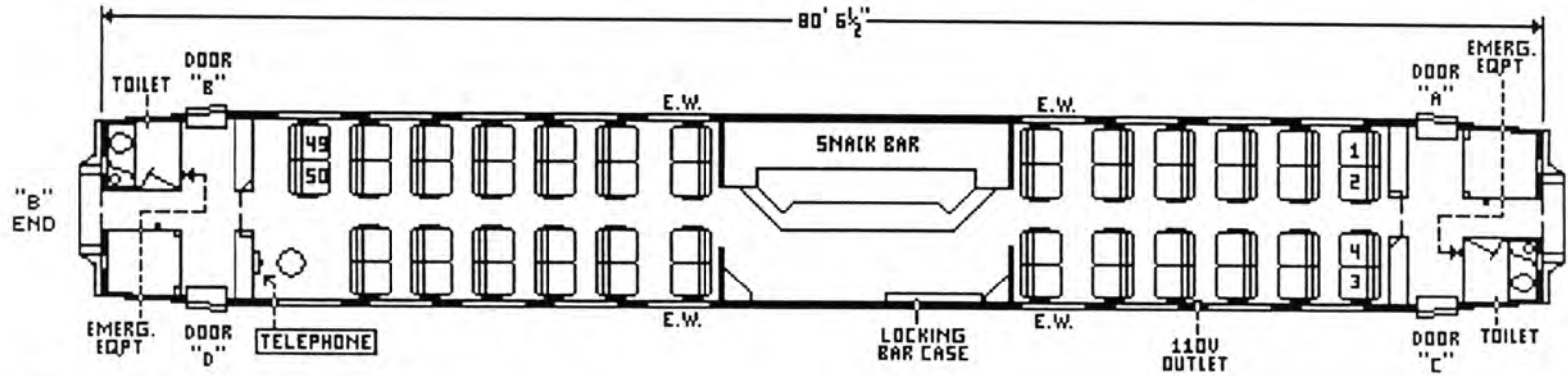
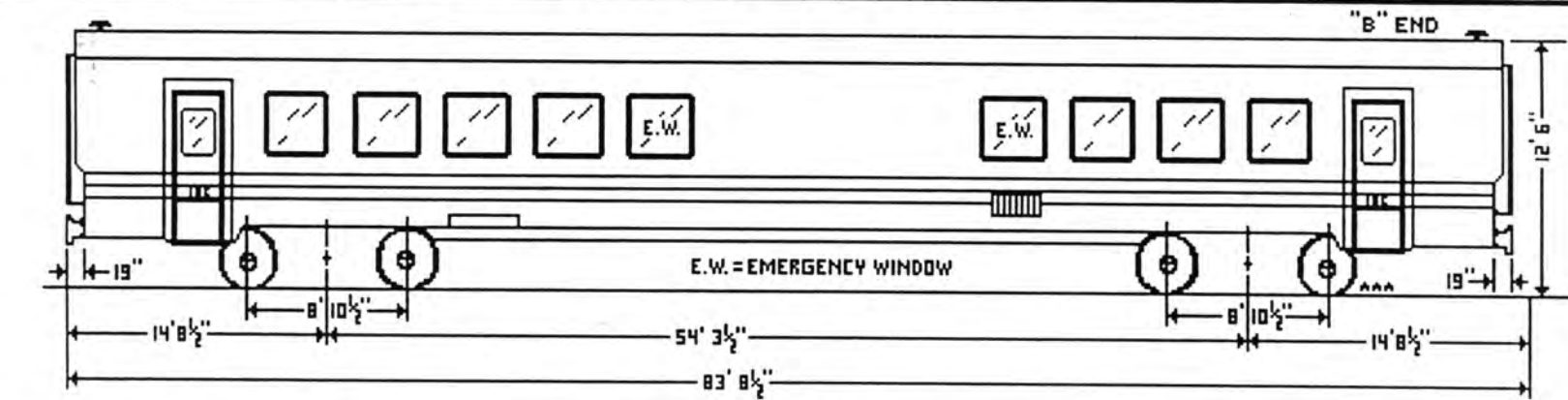

UNDERBODY VIEW THROUGH FLOOR

SEATS: 50

RTL TURBO COACH

Equipment Code: TS

125 MPH

Car Numbers: 179, 181

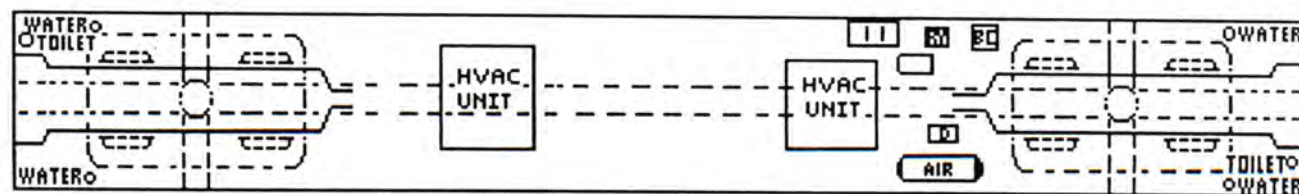
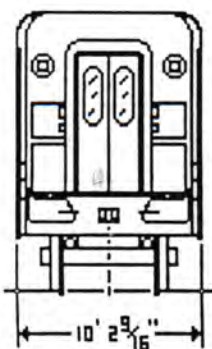
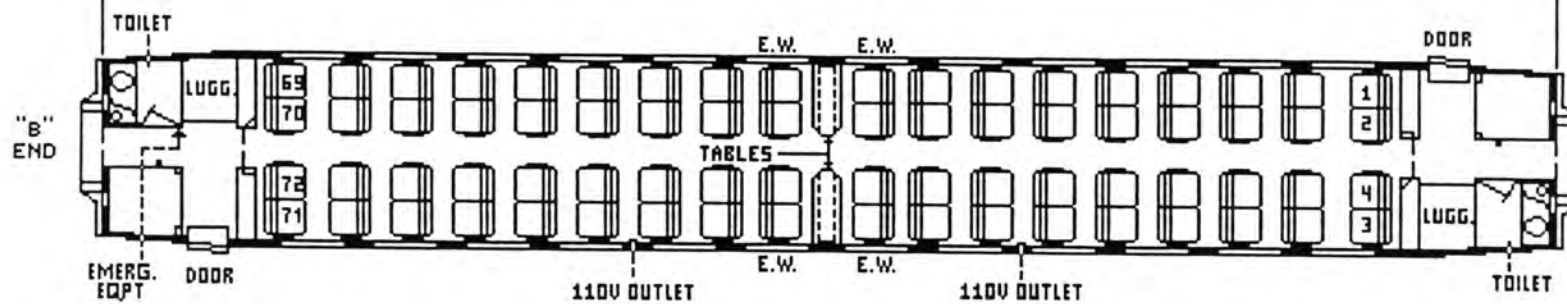
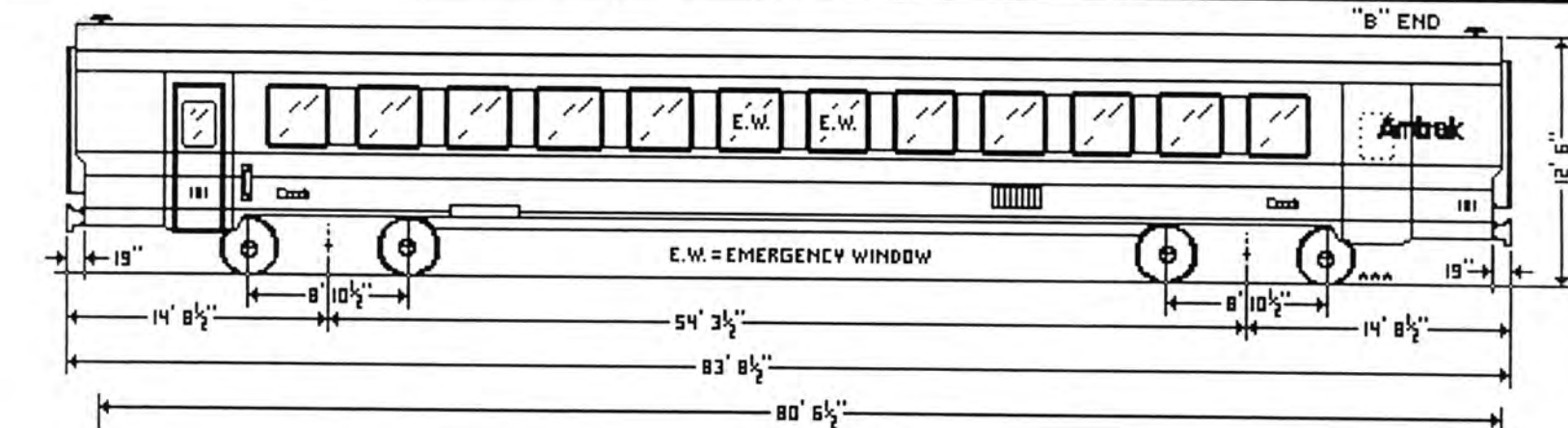

UNDERBODY VIEW THROUGH FLOOR

N.Y. STATE HIGH-SPEED TURBO SET

SEATS: 72

RTL TURBO CAFE

Equipment Code: TF

125 MPH

Car Number: 180

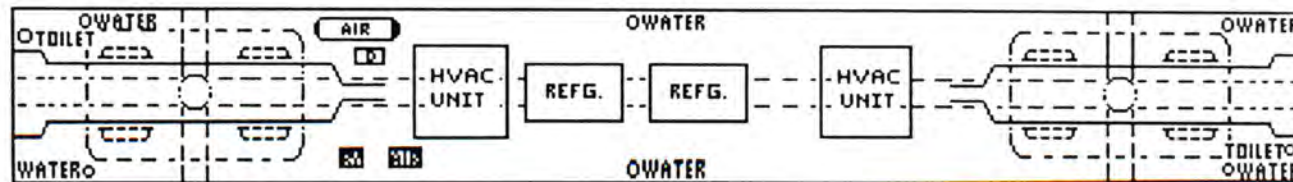
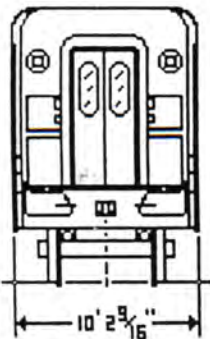
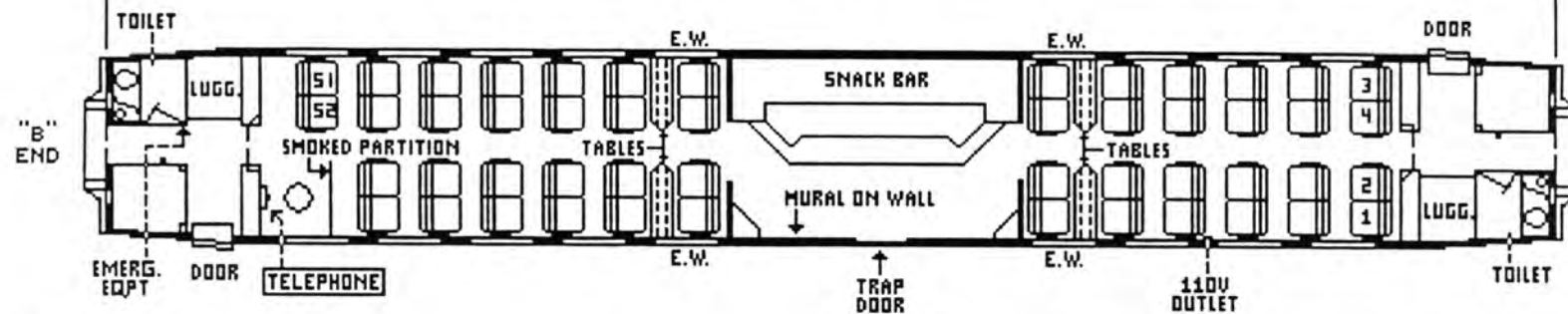
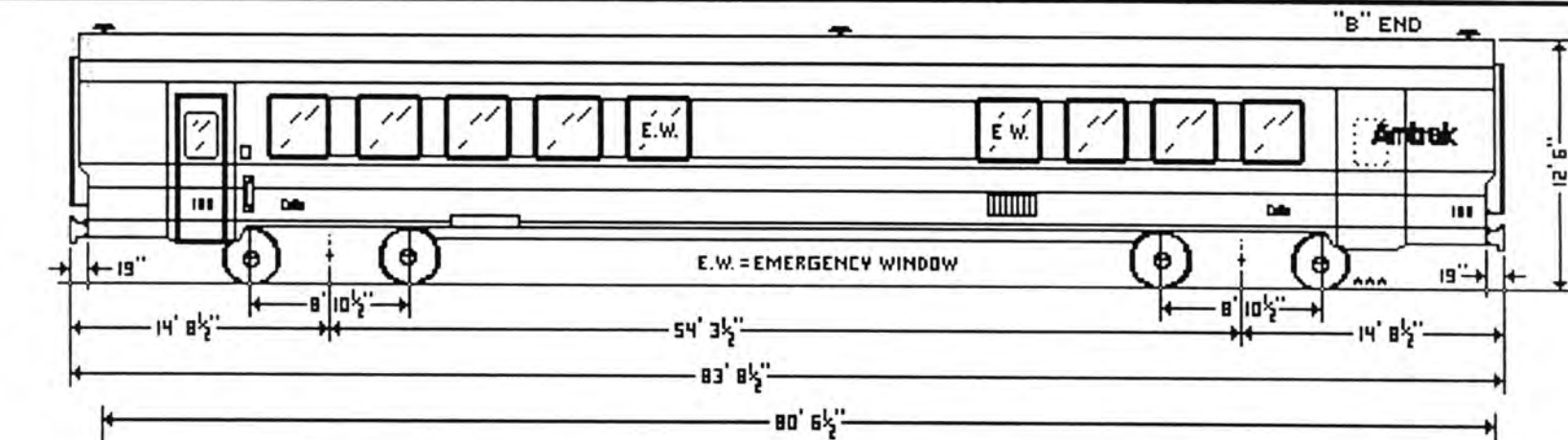

UNDERBODY VIEW THROUGH FLOOR

N.Y. STATE HIGH-SPEED TURBO SET

SEATS: 50

HERITAGE BAGGAGE CAR

Equipment Code: BA

110 MPH

Car Numbers: 1000-1006

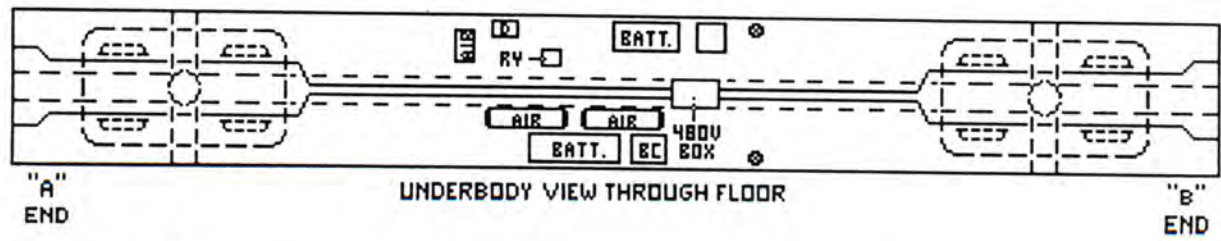
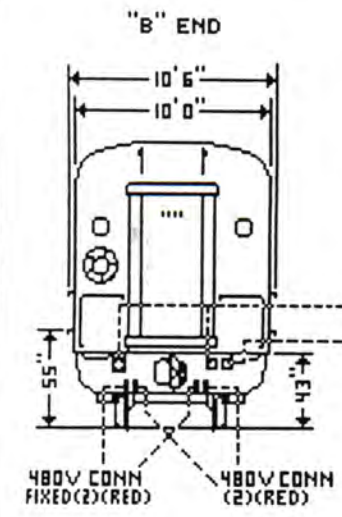
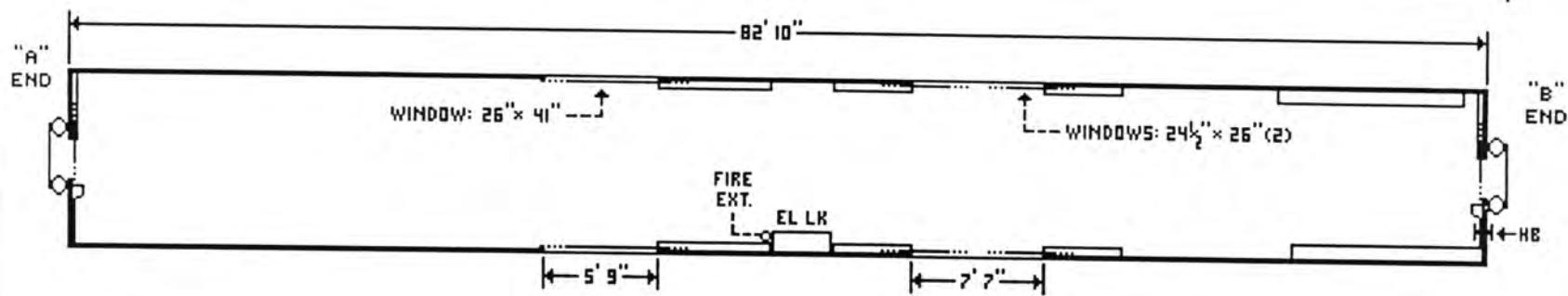
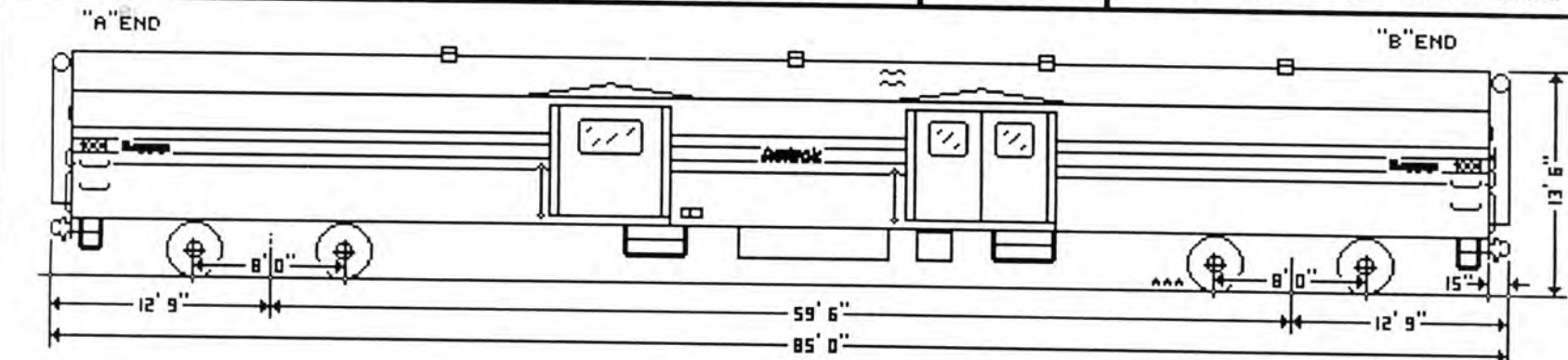

1002: EQUIPPED WITH 1 ROLL-UP DOOR EACH SIDE IN PLACE OF DOUBLE DOORS.
1003: NO WINDOWS IN SIDE DOORS

HERITAGE BAGGAGE CAR

Equipment Code: BA

110 MPH

Car Numbers: 1128-1131

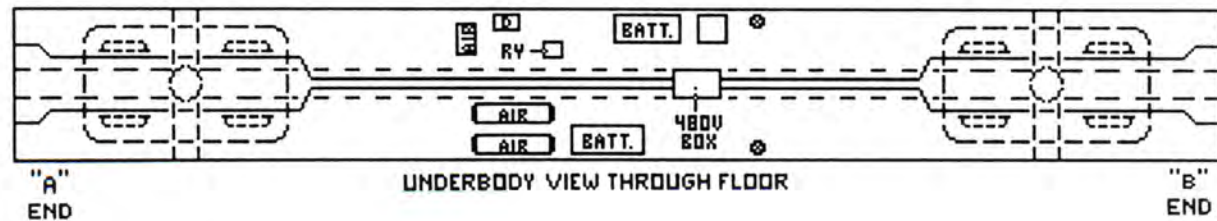
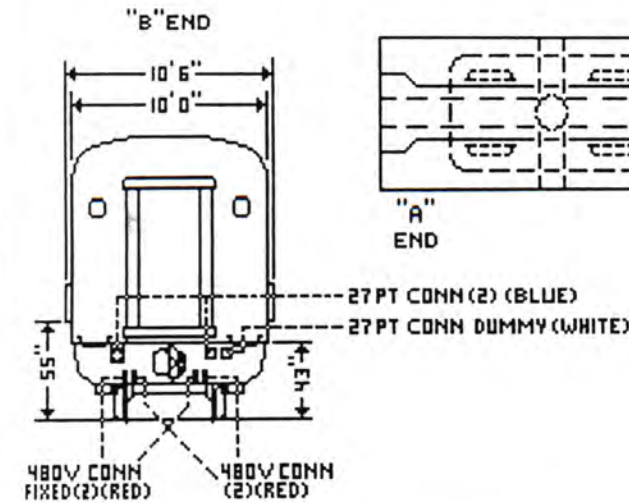
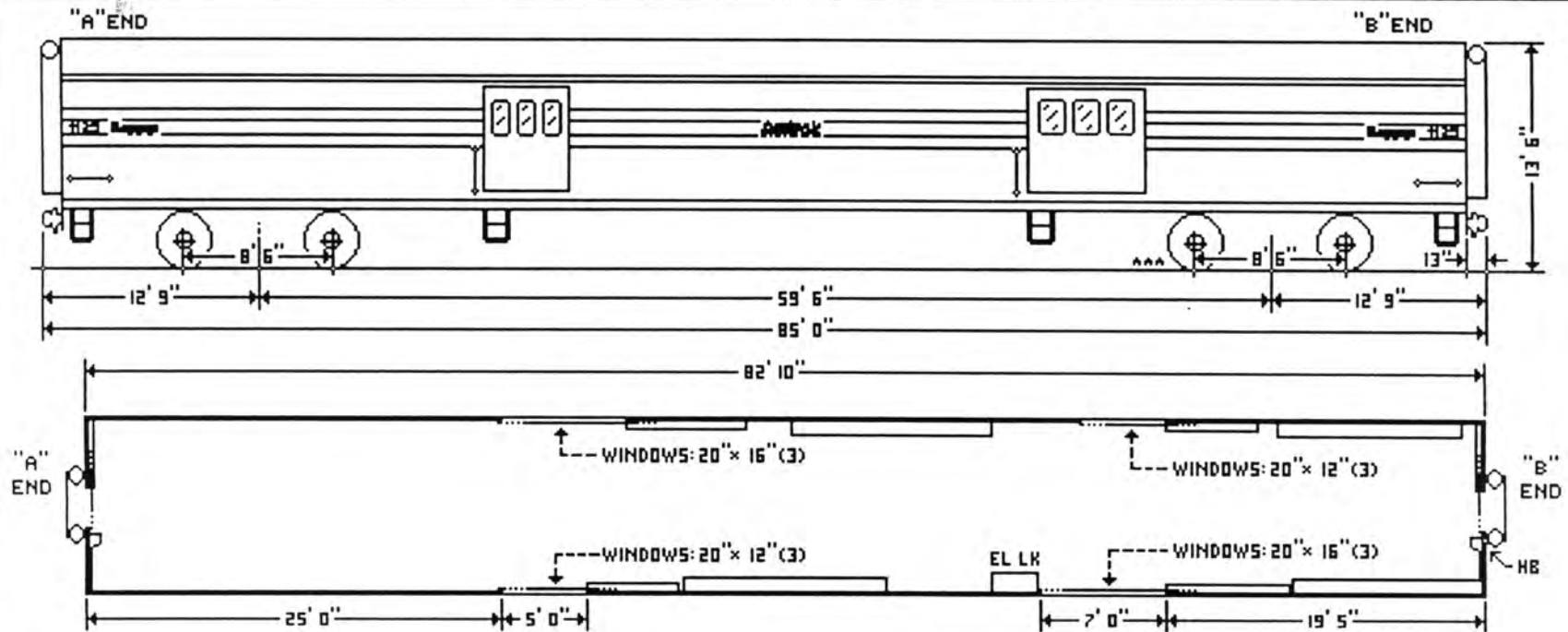

HERITAGE BAGGAGE CAR

Equipment Code: BA

110 MPH

Car Number : 1132

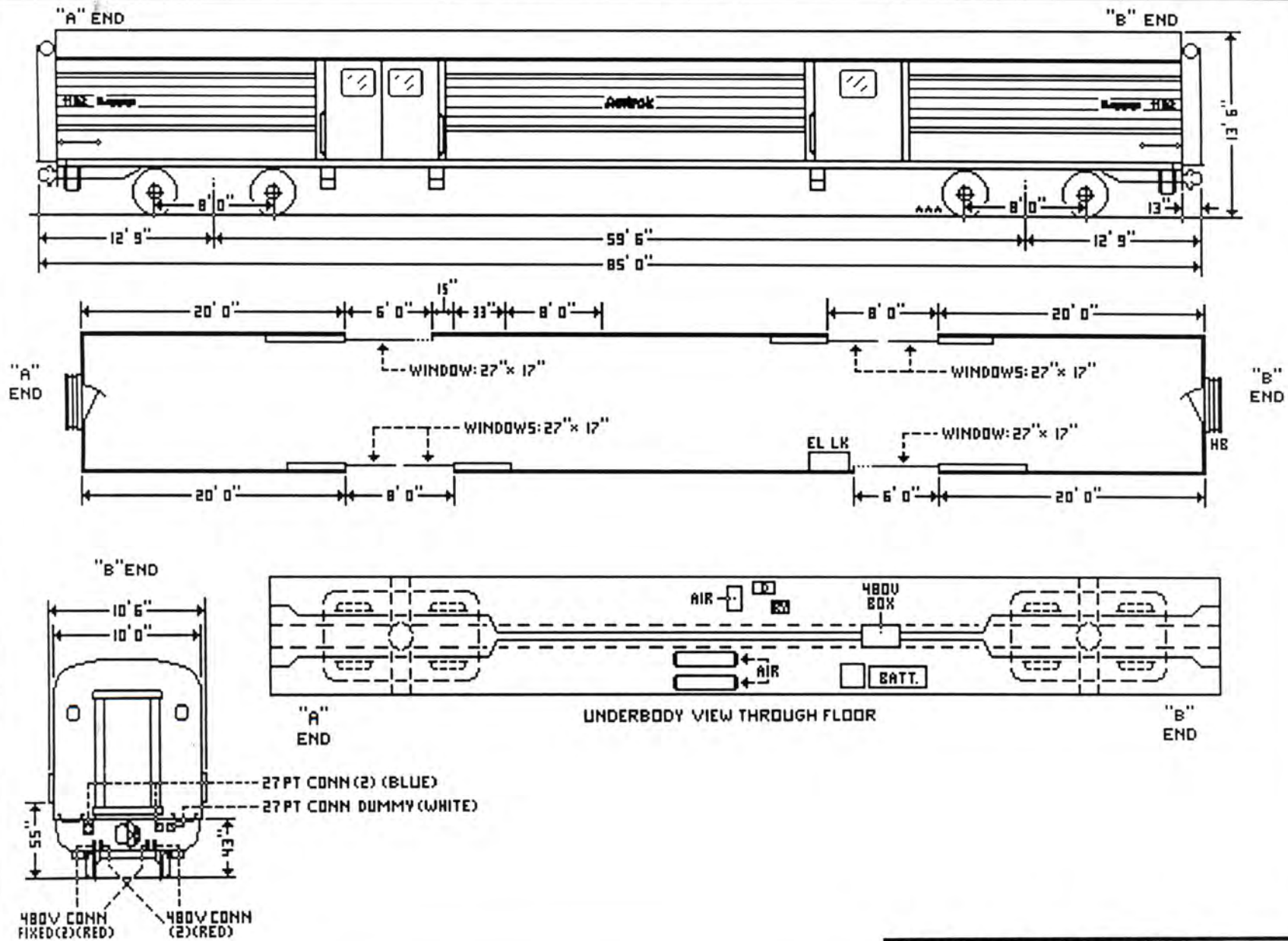

HERITAGE BAGGAGE CAR

Equipment Code: BA

110 MPH

Car Number : 1133

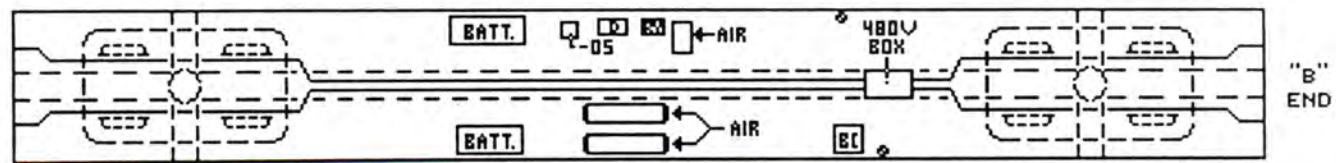
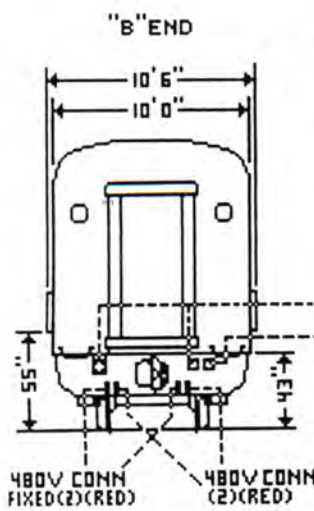
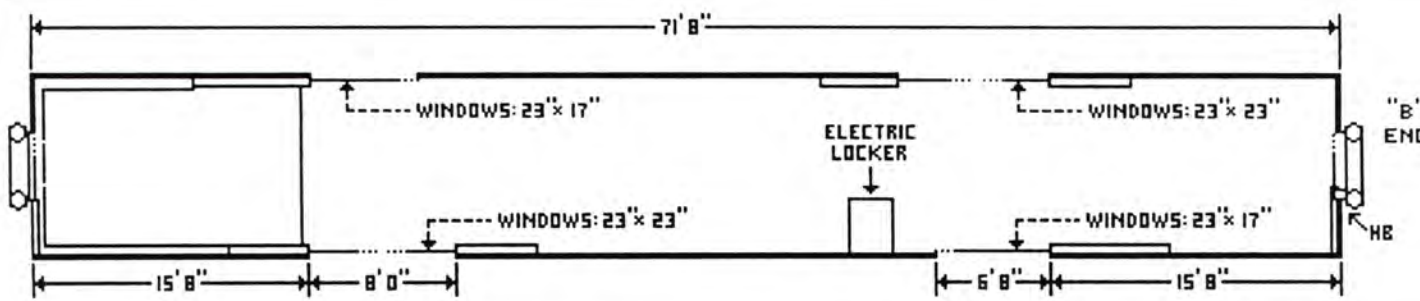
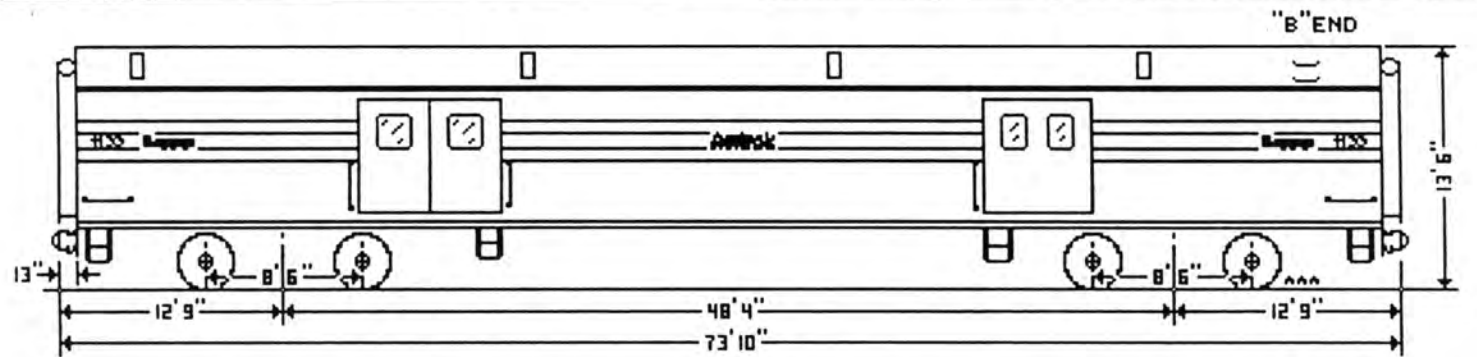

UNDERBODY VIEW THROUGH FLOOR

HERITAGE BAGGAGE CAR

Equipment Code: BA

110 MPH

Car Numbers: 1134-1135

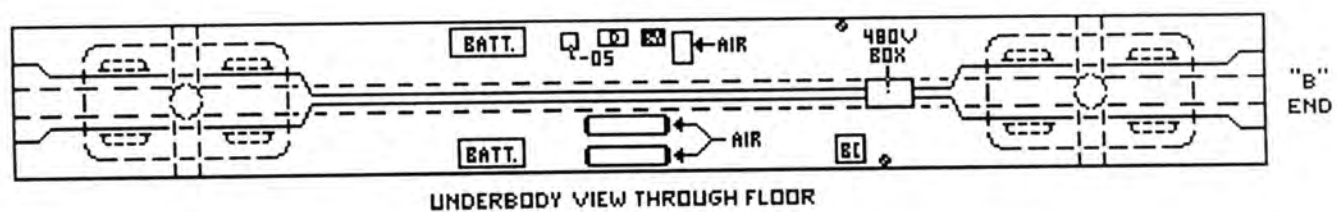
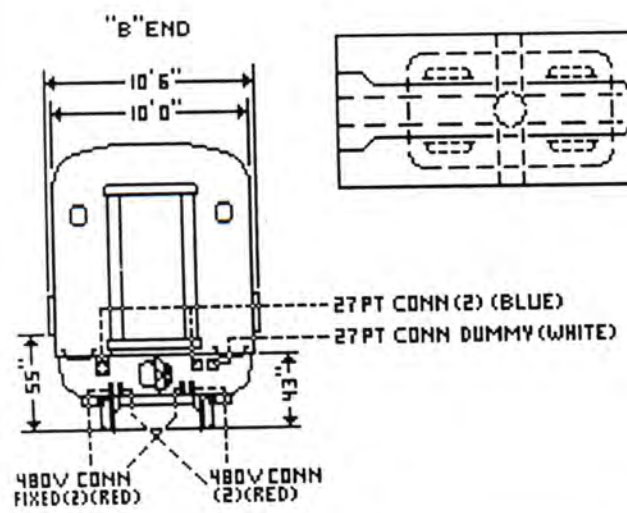
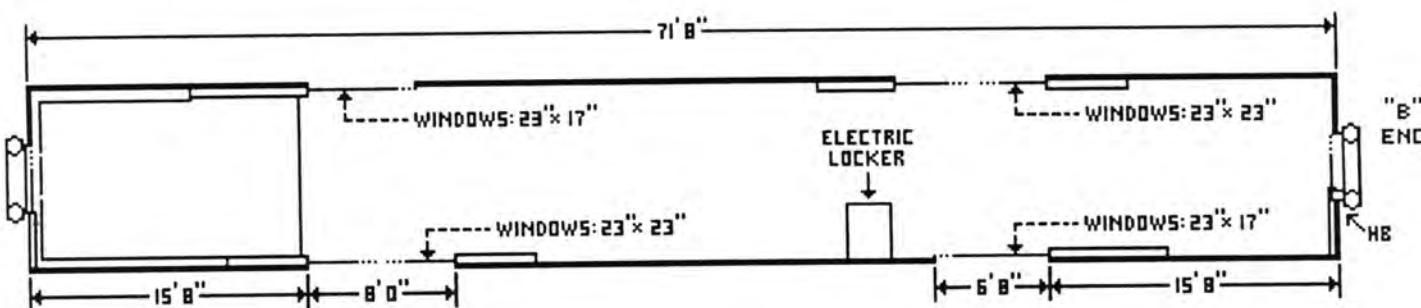
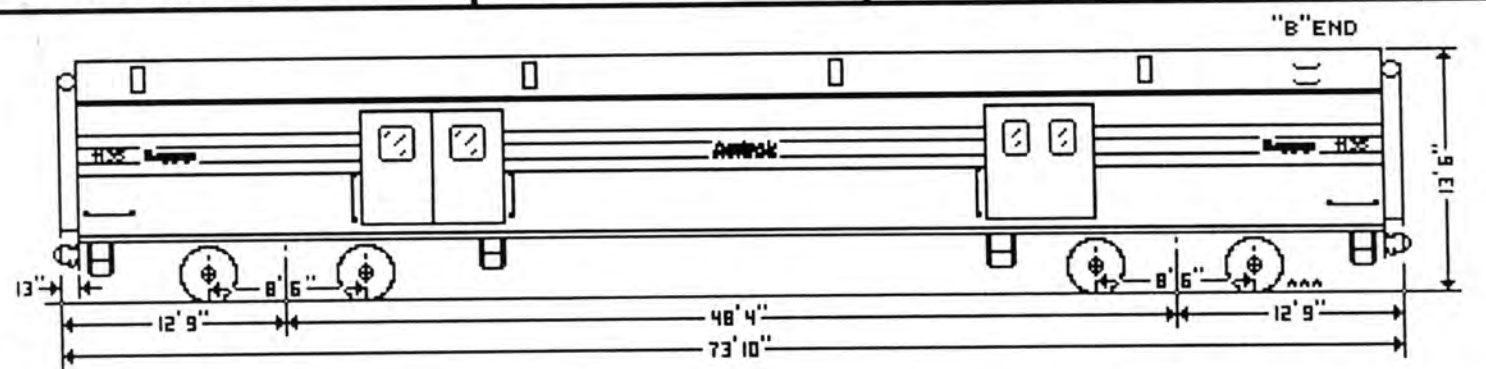

HERITAGE BAGGAGE CAR

Equipment Code: BA

110 MPH

Car Numbers: 1137 - 1138

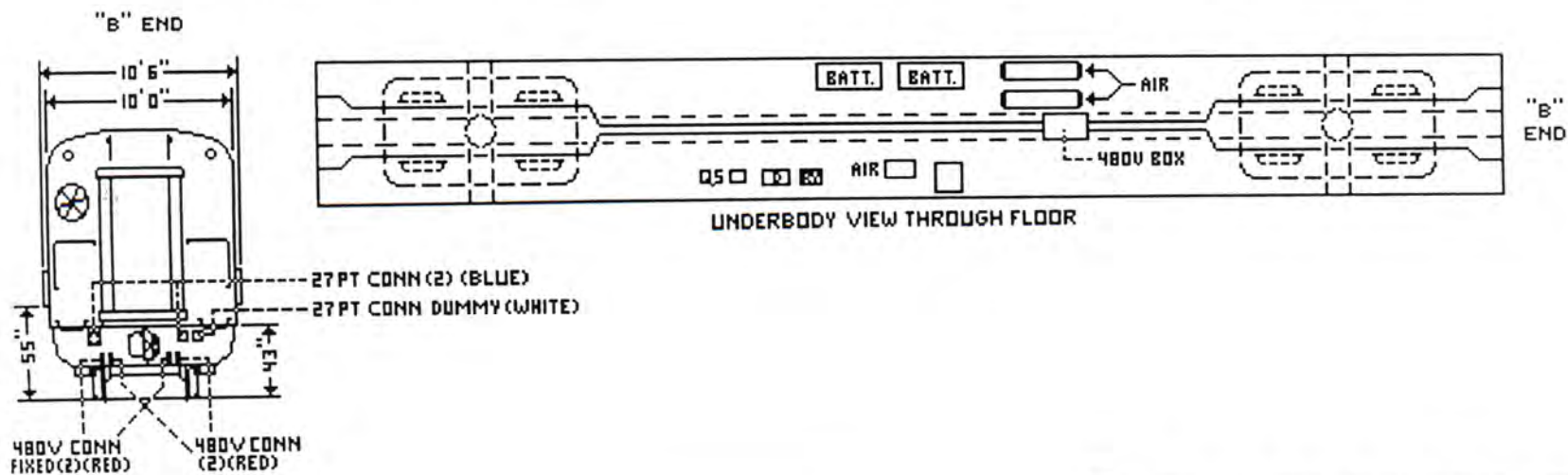
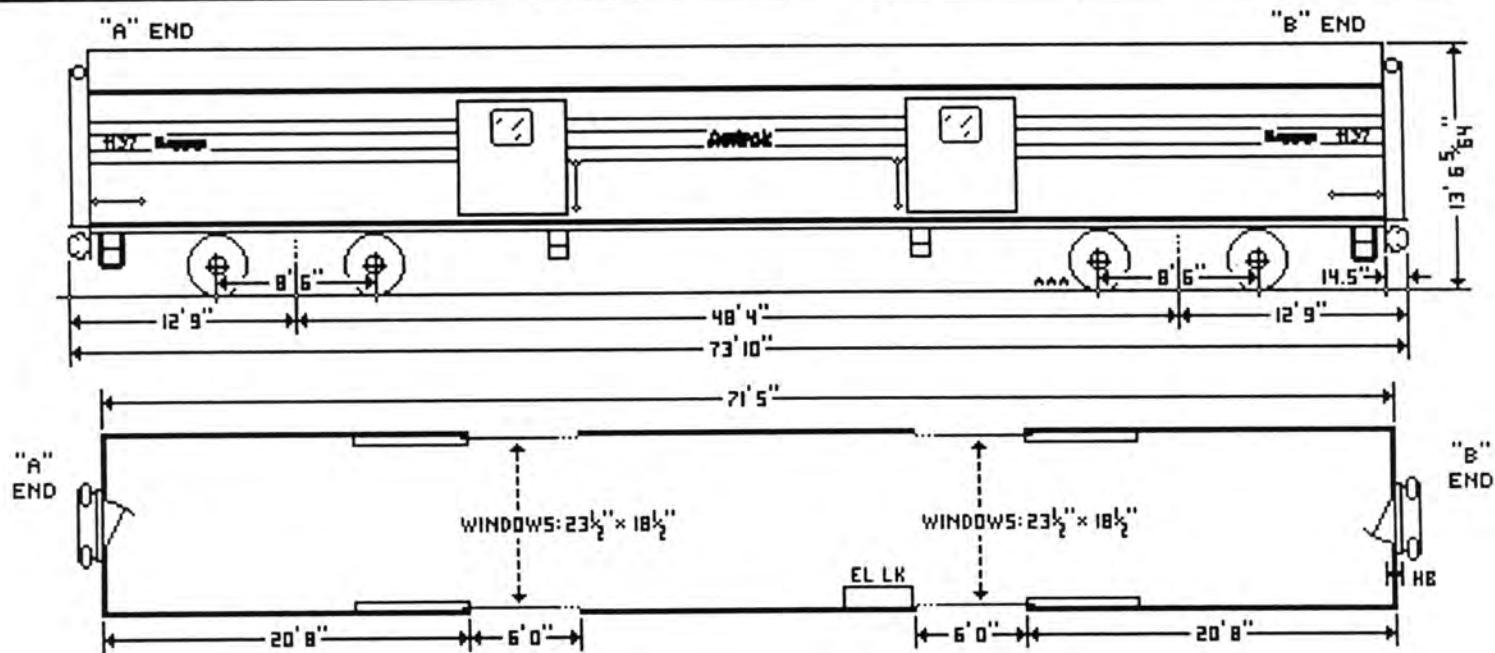

HERITAGE BAGGAGE CAR

Equipment Code: BA

110 MPH

Car Numbers: 1159, 1161-1165, 1173

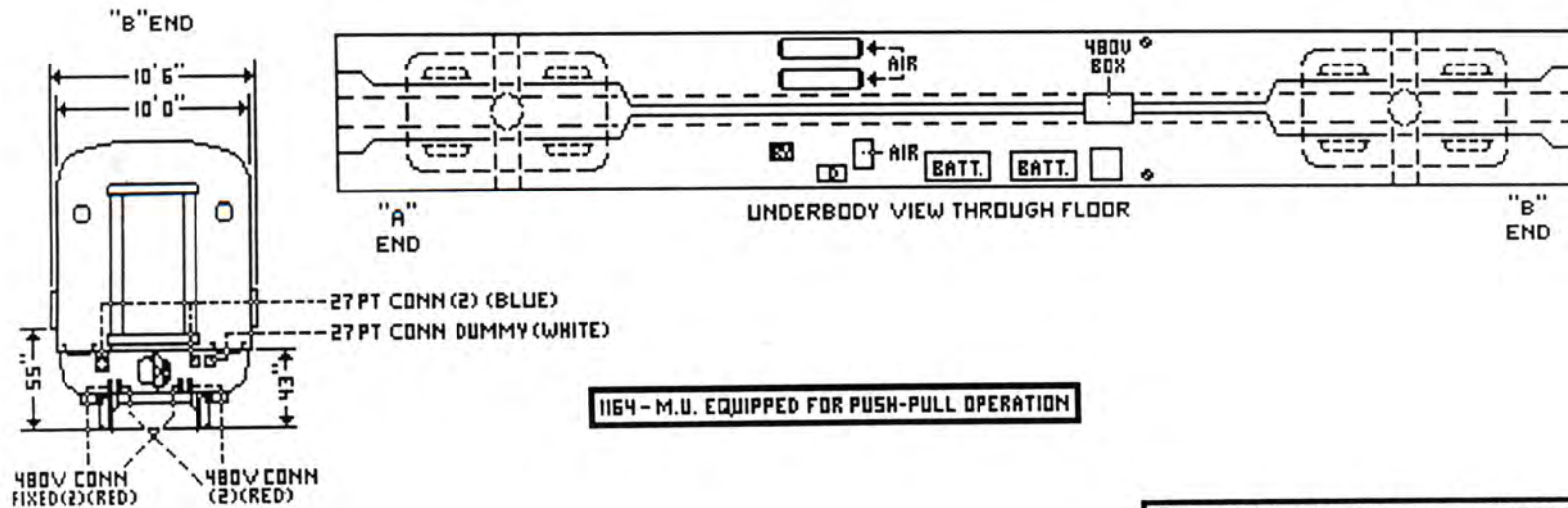
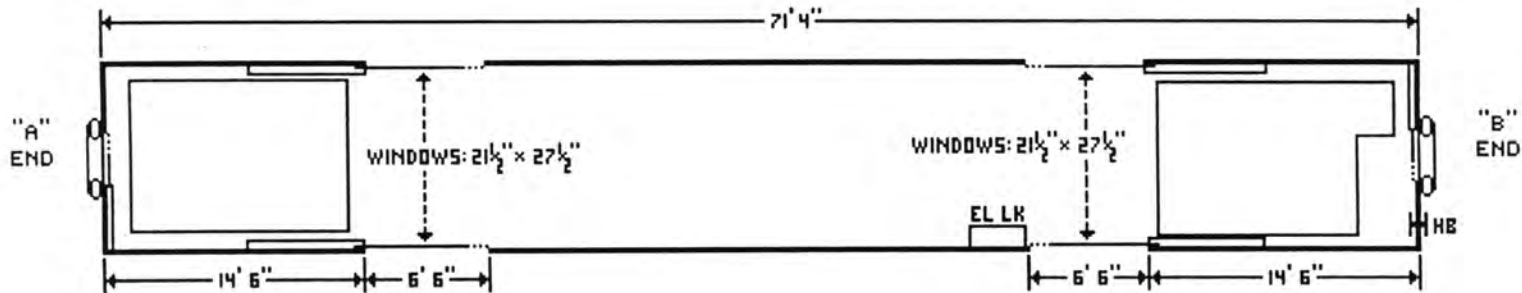
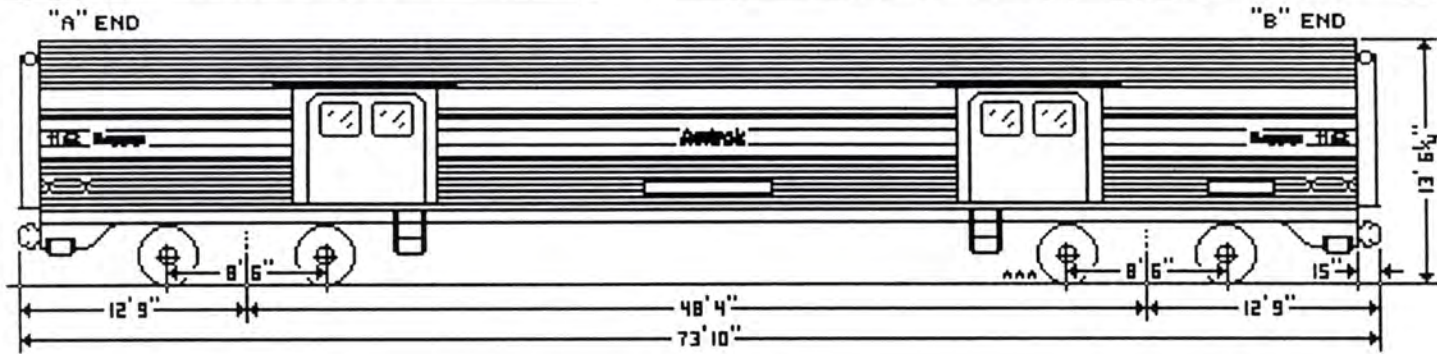

HERITAGE BAGGAGE CAR

Equipment Code: BA

110 MPH

Car Numbers: 1160, 1166

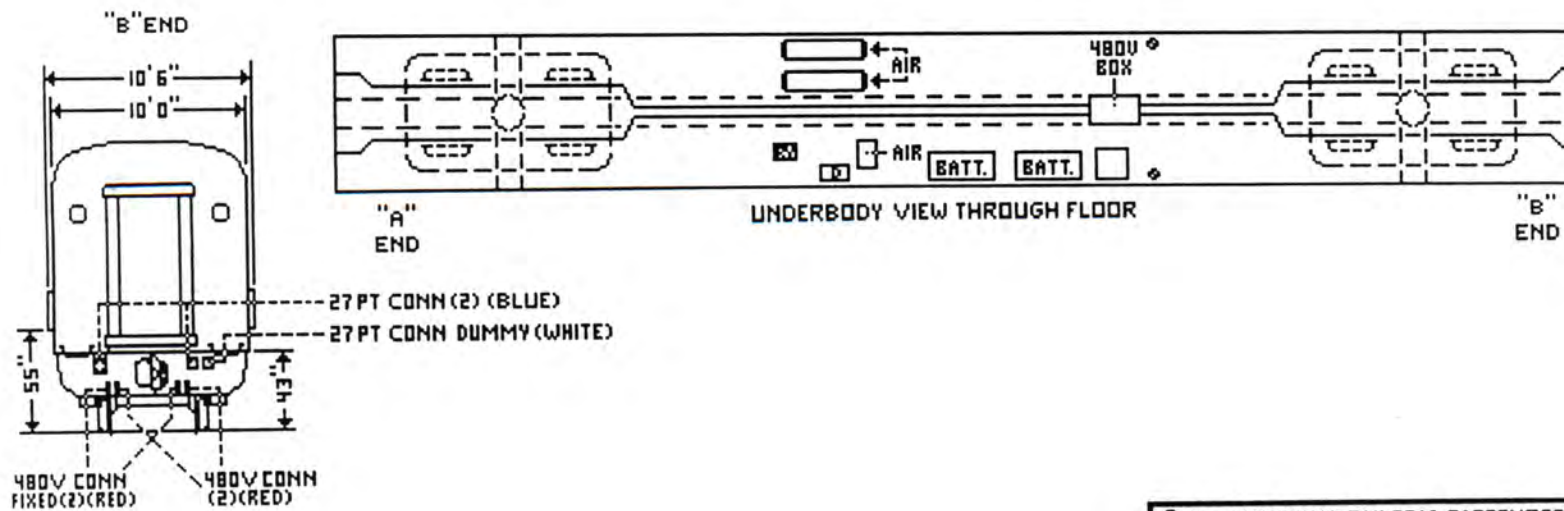
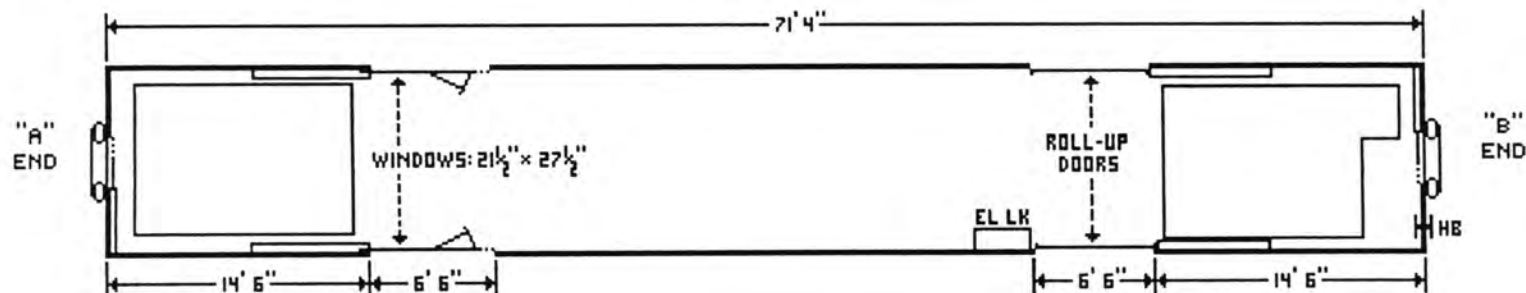
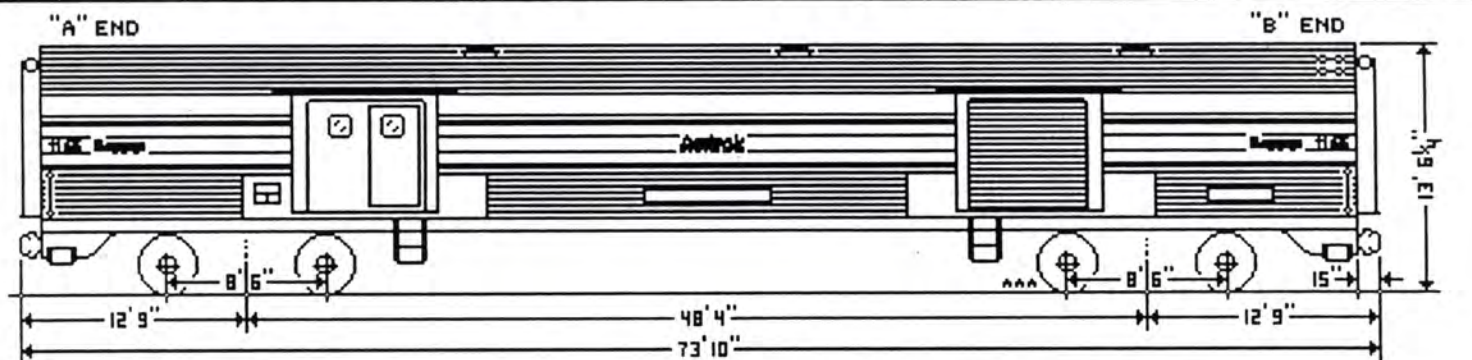

HERITAGE BAGGAGE CAR

Equipment Code: BA

110 MPH

Car Number : 1167

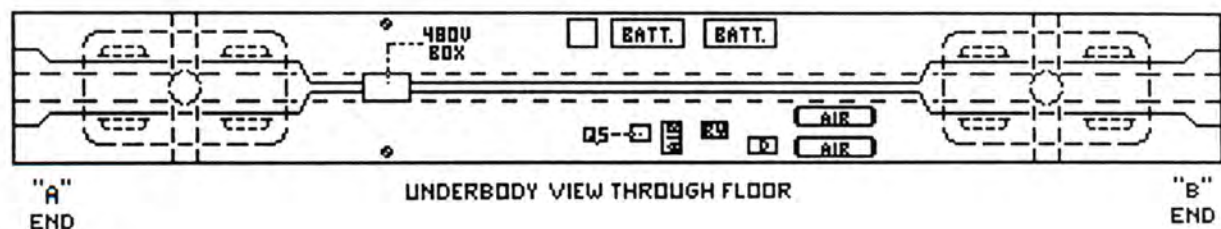
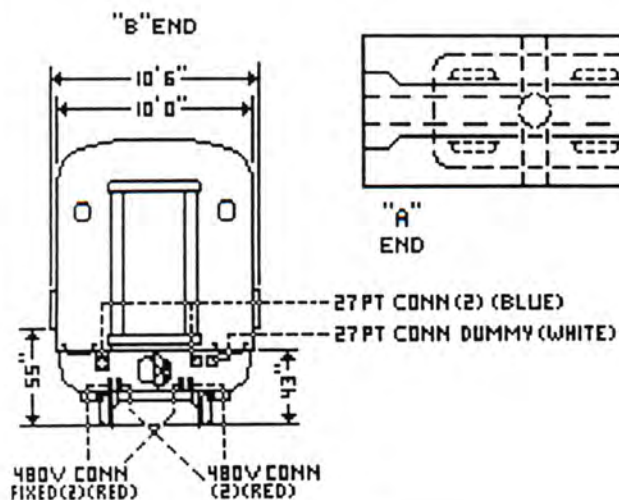
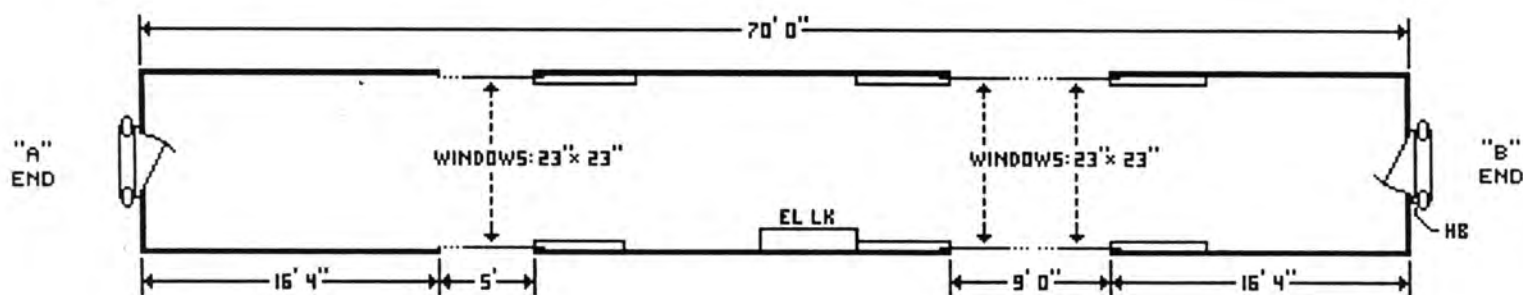
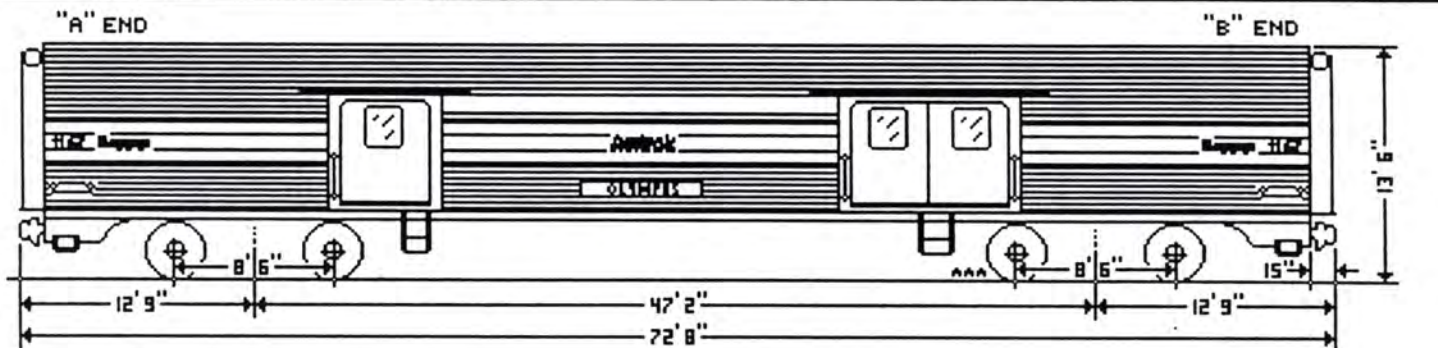

1167 - OLYMPUS

HERITAGE BAGGAGE CAR

Equipment Code: BA

110 MPH

Car Numbers: 1170-1172

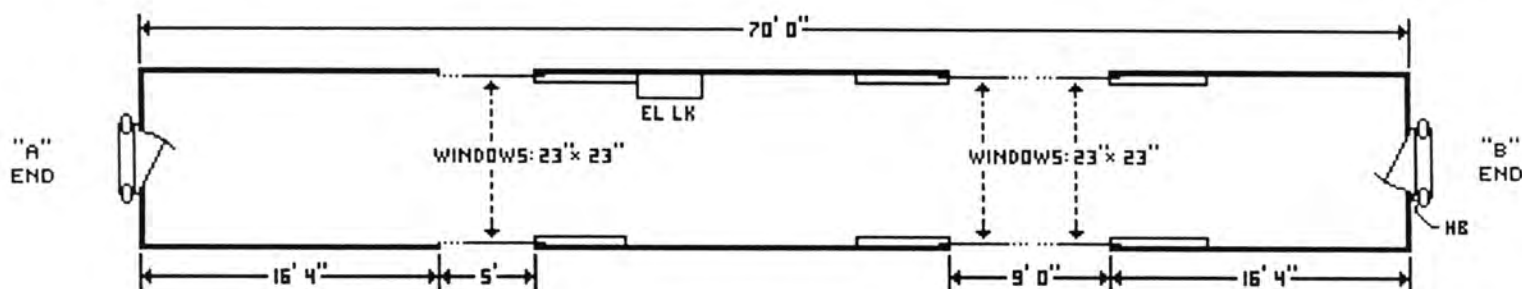
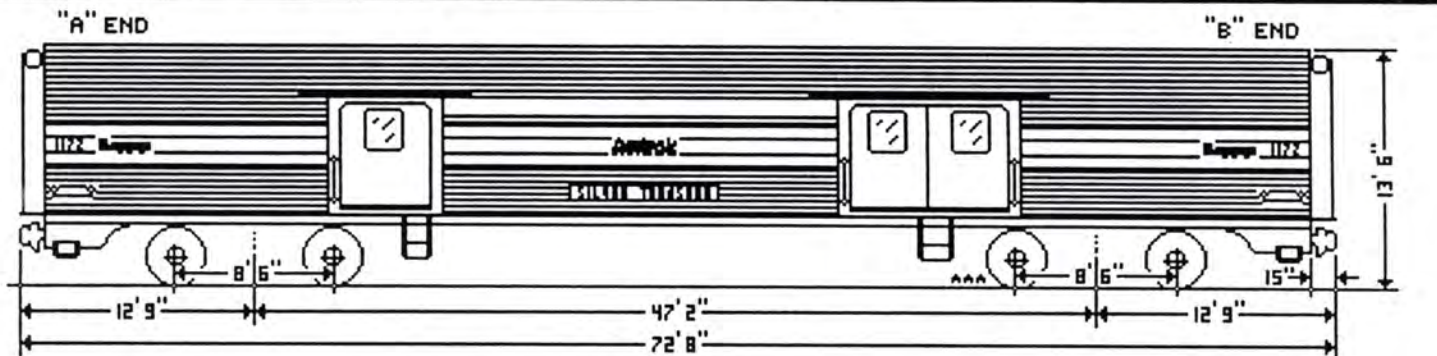

1172 - SOLID DOORS, NO WINDOWS

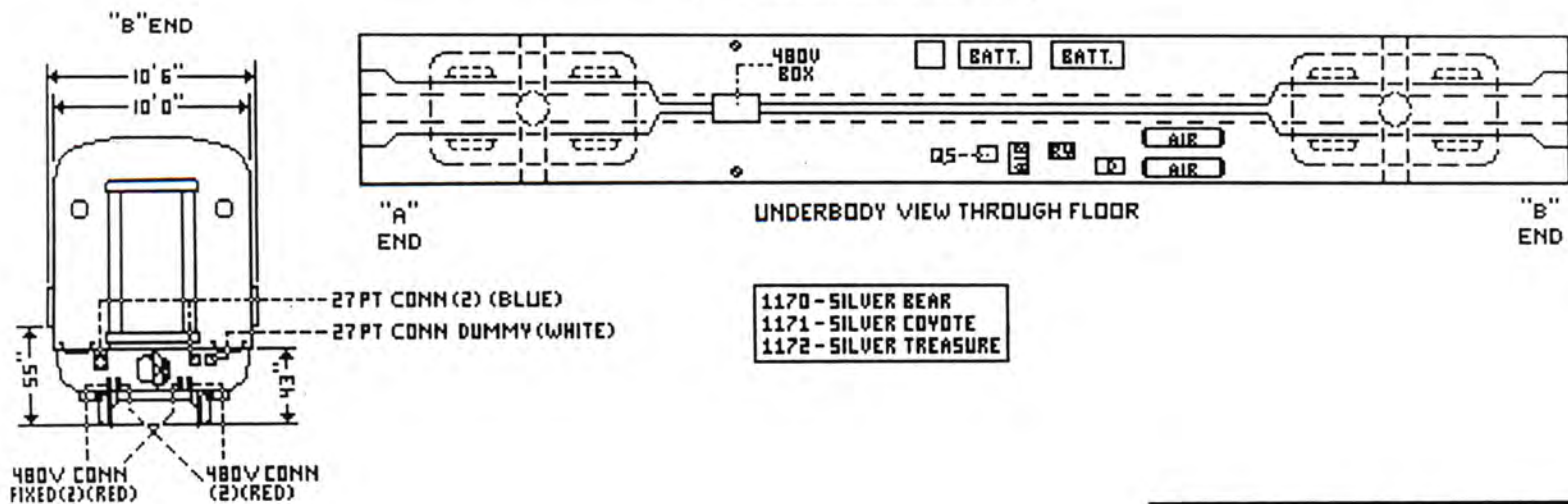

HERITAGE BAGGAGE CAR

Equipment Code: BA

110 MPH

Car Number : 1176

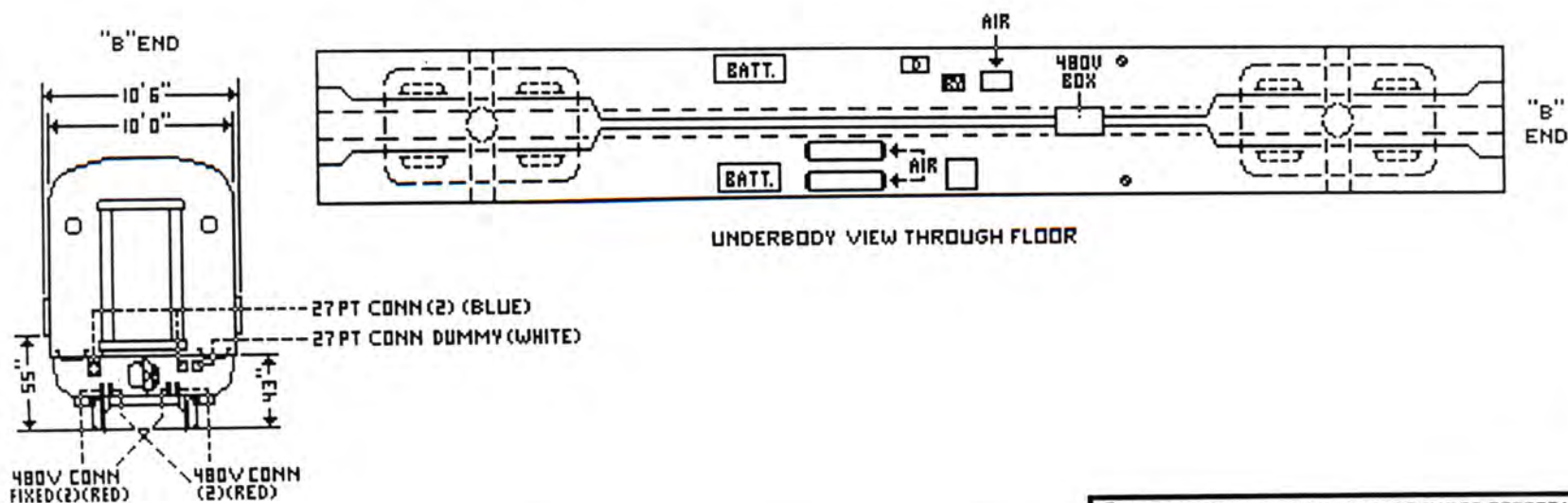
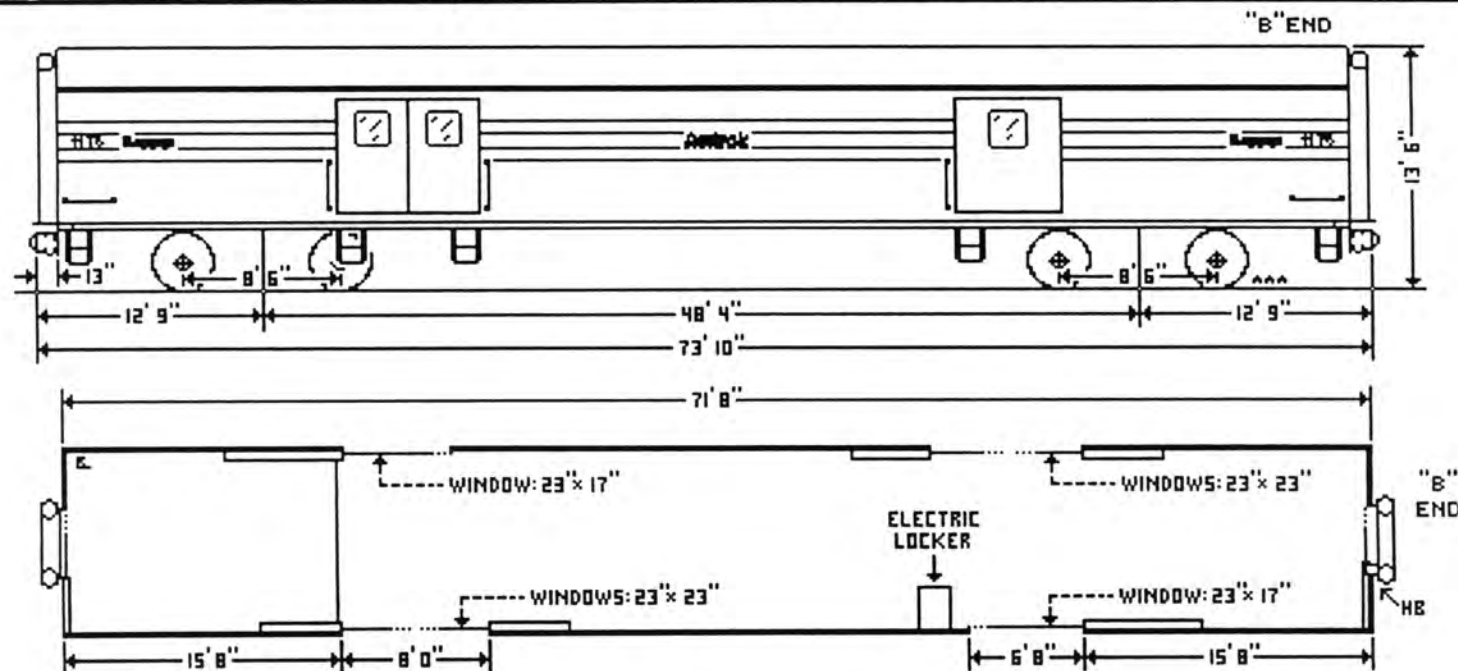

HERITAGE BAGGAGE CAR

Equipment Code: BA

110 MPH

Car Numbers: 1178-1181, 1183-1195

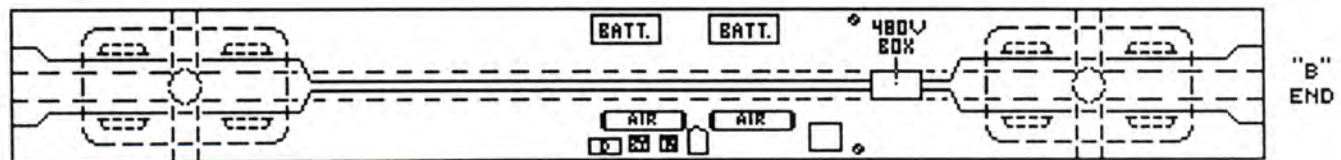
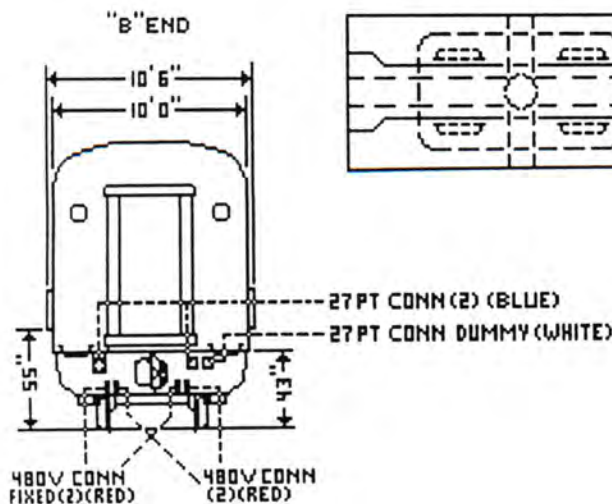
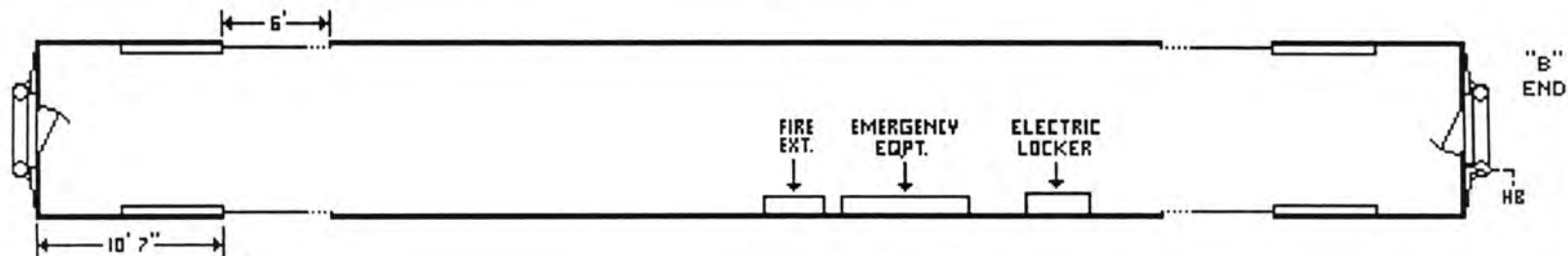
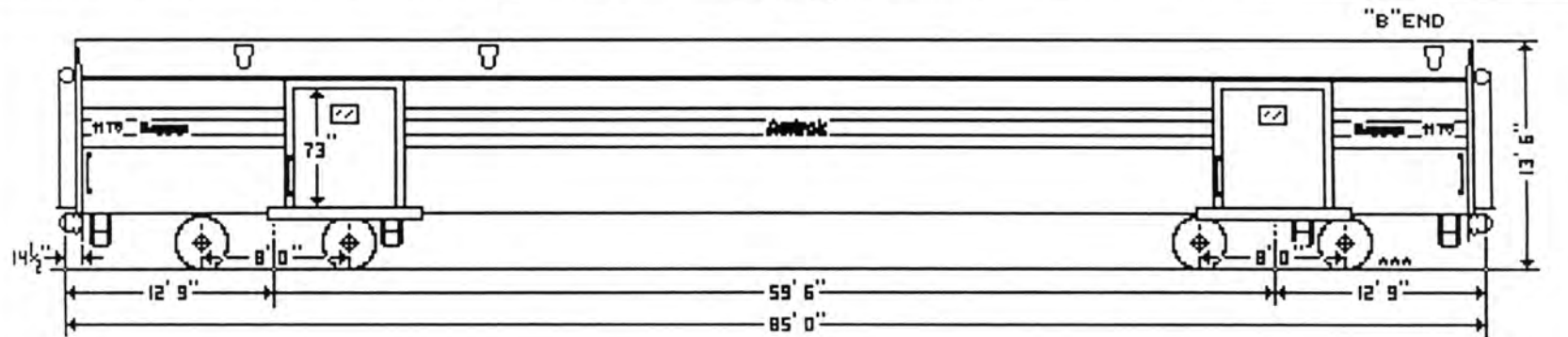

UNDERBODY VIEW THROUGH FLOOR

HERITAGE BAGGAGE CAR

Equipment Code: BA

110 MPH

Car Numbers: 1203-1249

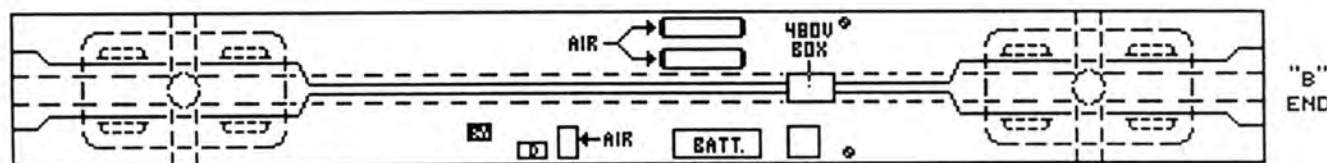
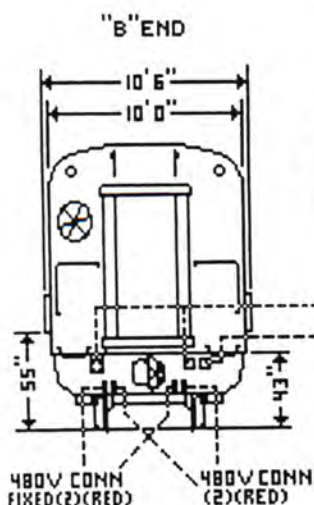
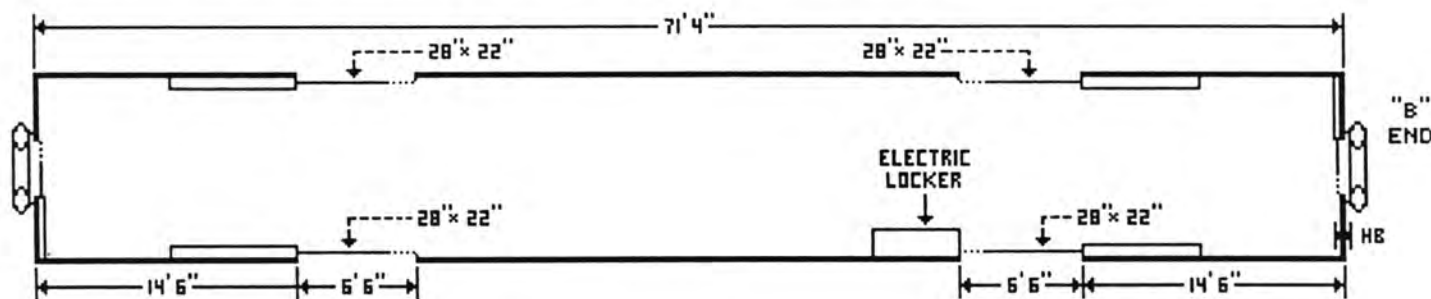
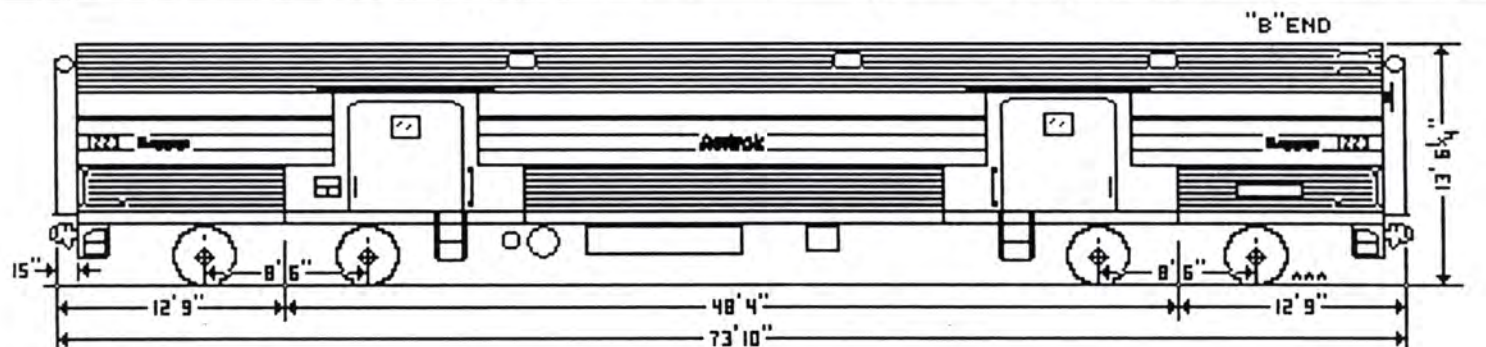

1236, 1244: EQUIPPED WITH ROLL-UP DOORS

M.U. EQUIPPED CARS FOR PUSH-PULL OPERATION:
1204, 1213, 1221, 1222, 1223, 1226, 1228, 1241

HERITAGE BAGGAGE CAR

Equipment Code: BA

110 MPH

Car Numbers: 1250-1272

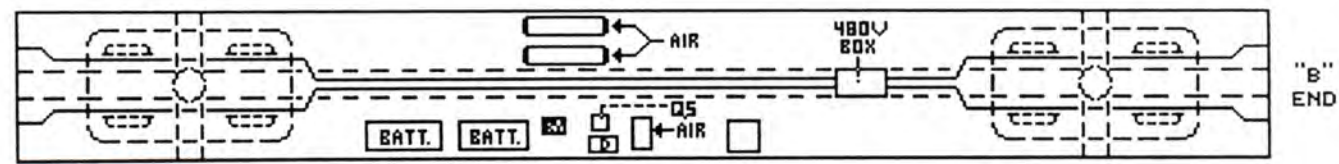
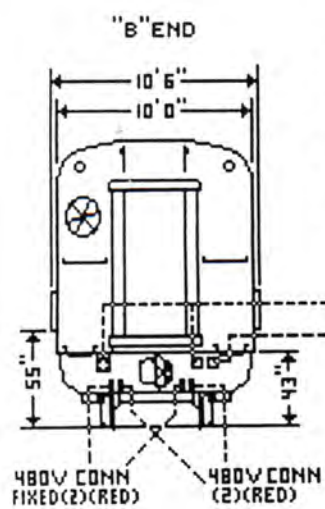
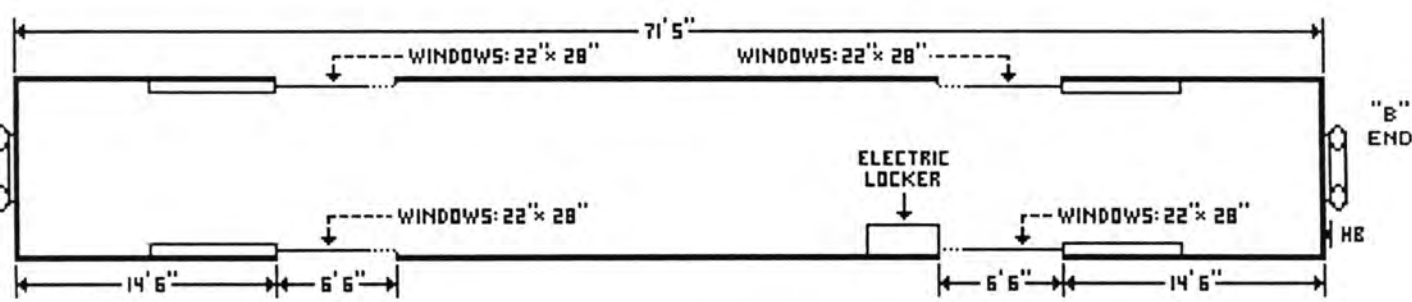
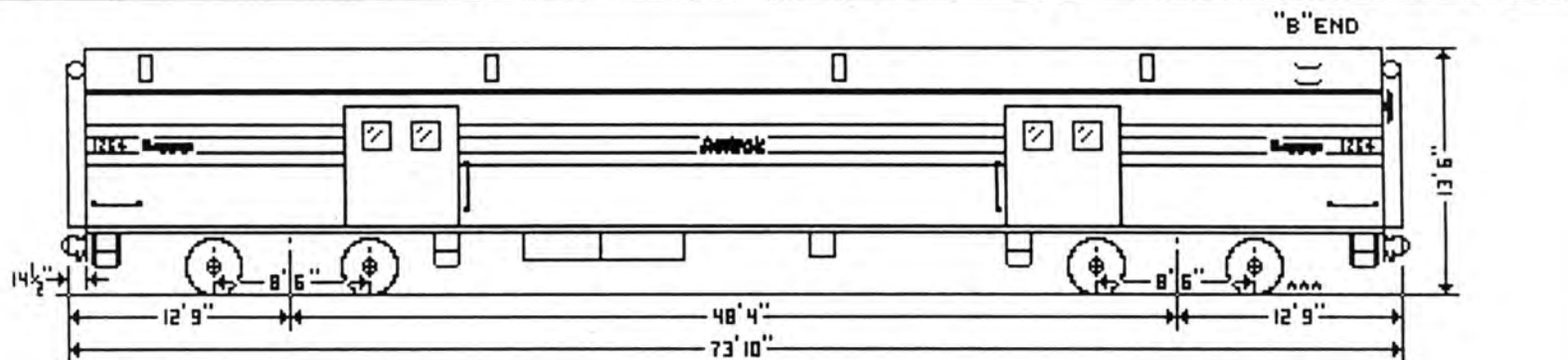

UNDERBODY VIEW THROUGH FLOOR

1251: EQUIPPED WITH ROLL-UP DOORS

HERITAGE BAGGAGE CAR

Equipment Code: BA

110 MPH

Car Numbers: 1350-1379

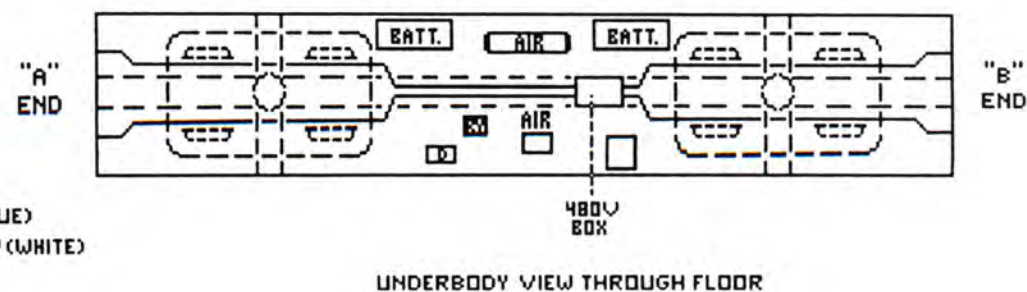
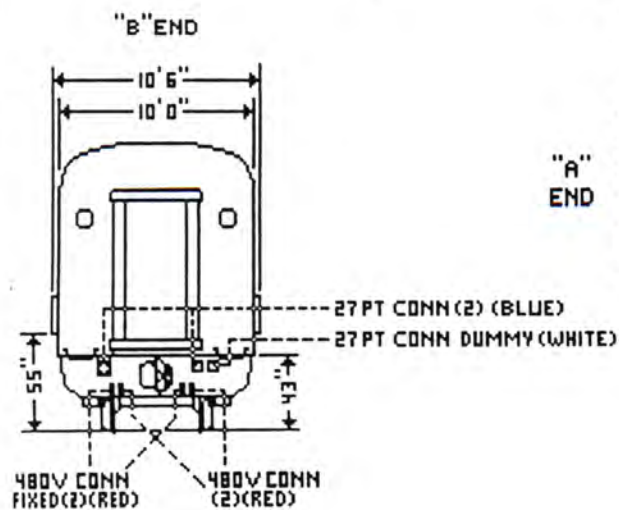
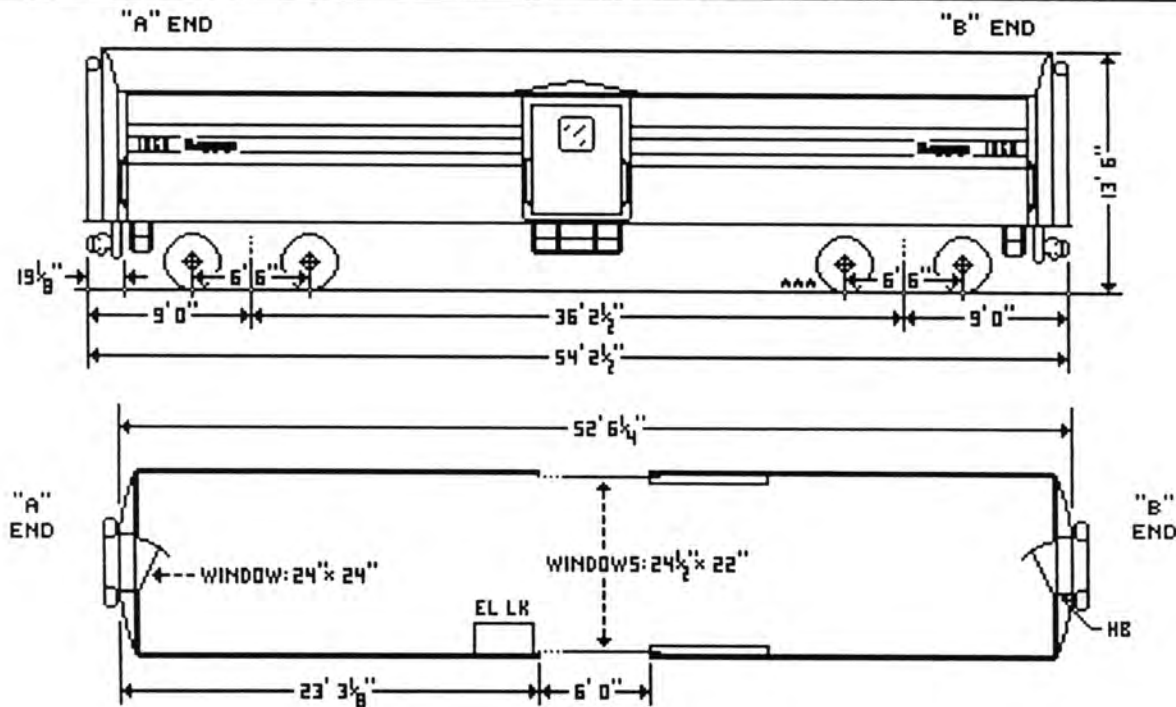

MATERIAL HANDLING CAR

Equipment Code: MH

110 MPH

Car Numbers: 1400-1473

DOOR HEIGHT:
8' 9 7/16"

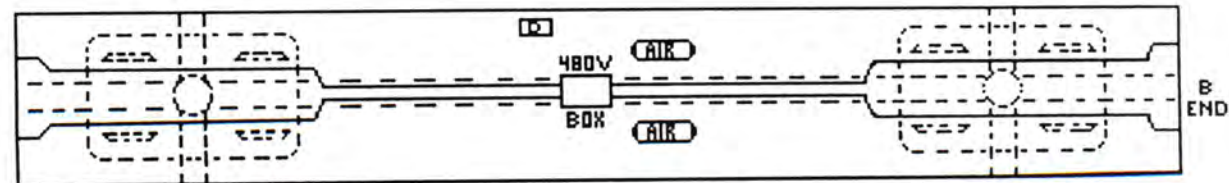
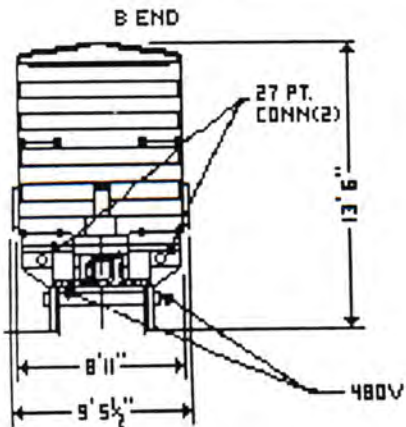
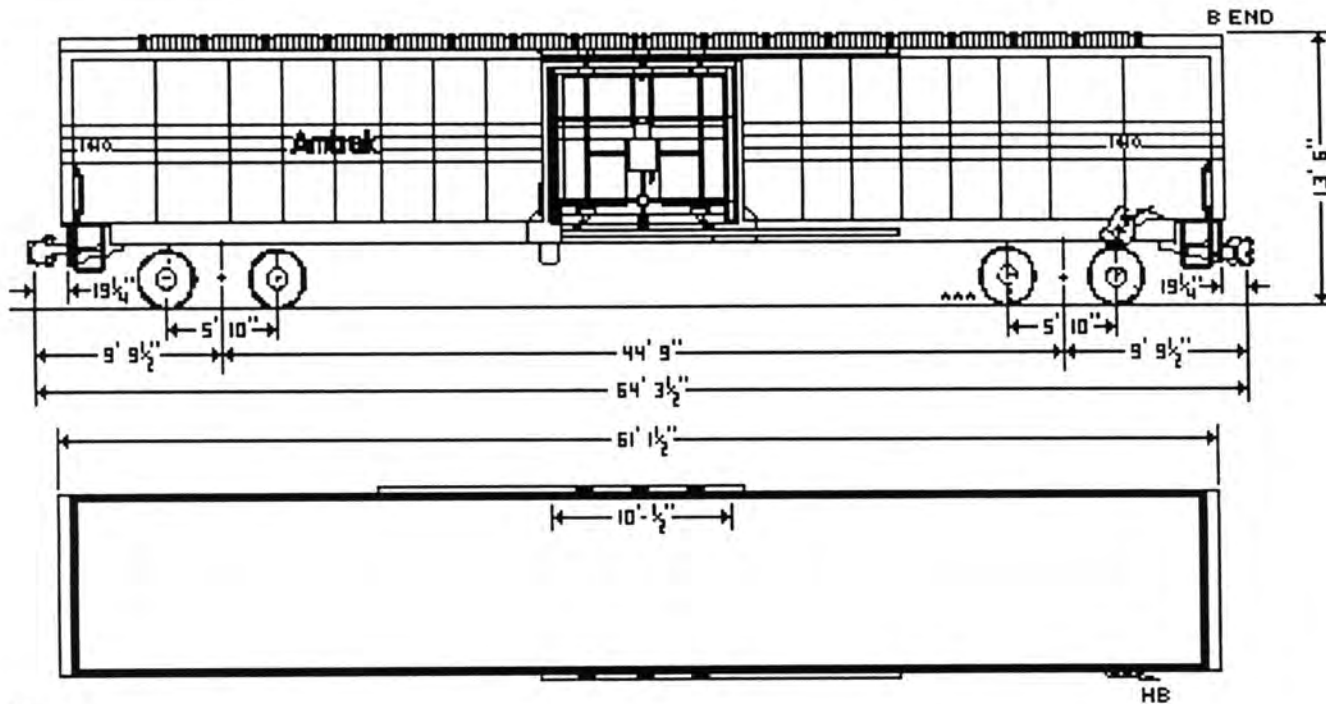

UNDERBODY VIEW THROUGH FLOOR

MATERIAL HANDLING CAR (SERIES II)

Equipment Code: MH

110 MPH

Car Numbers: 1500-1569

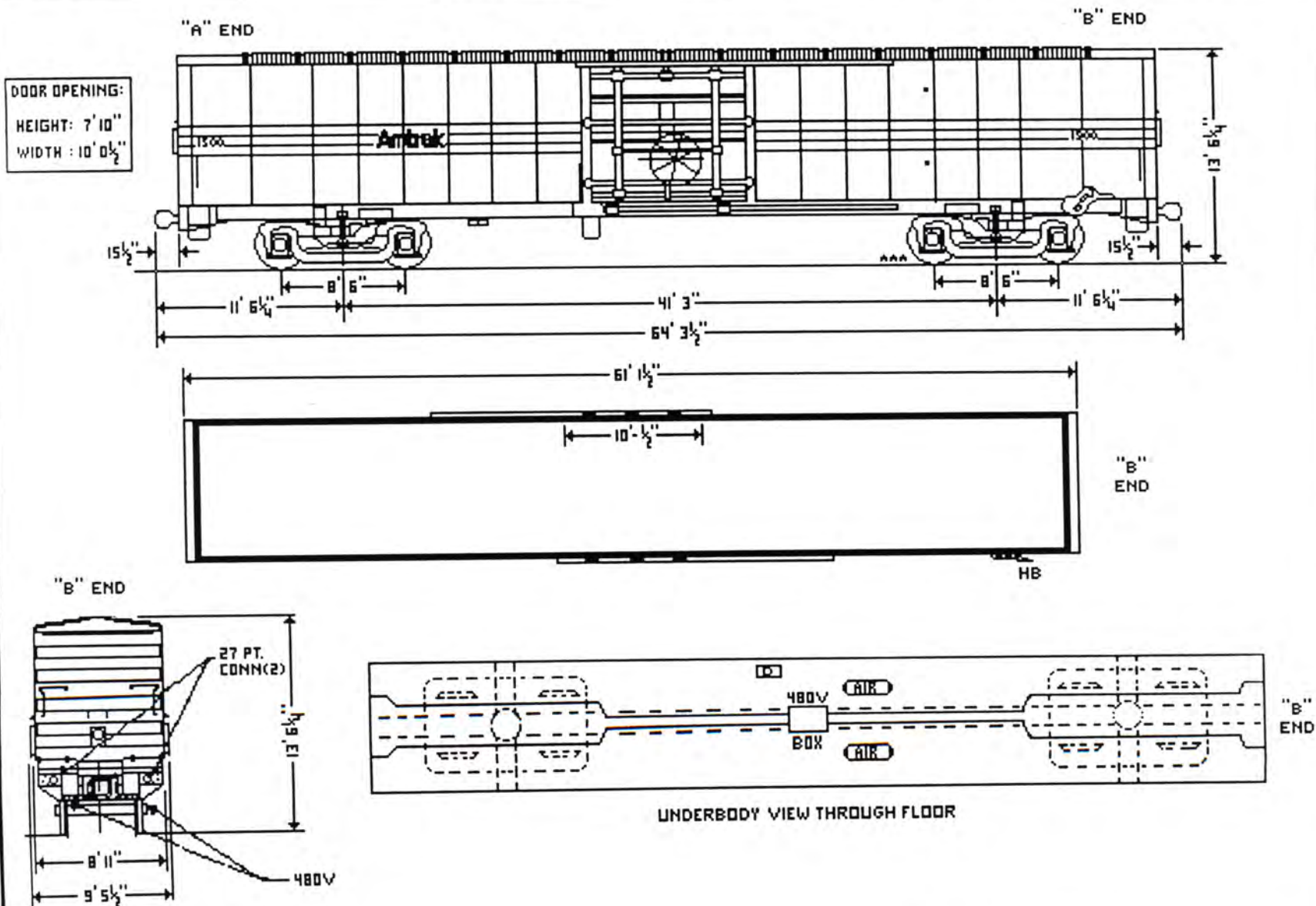

HERITAGE BAGGAGE-DORMITORY CAR

Eqpt. Code: BM

110 MPH

Car Numbers: 1615-1617, 1628

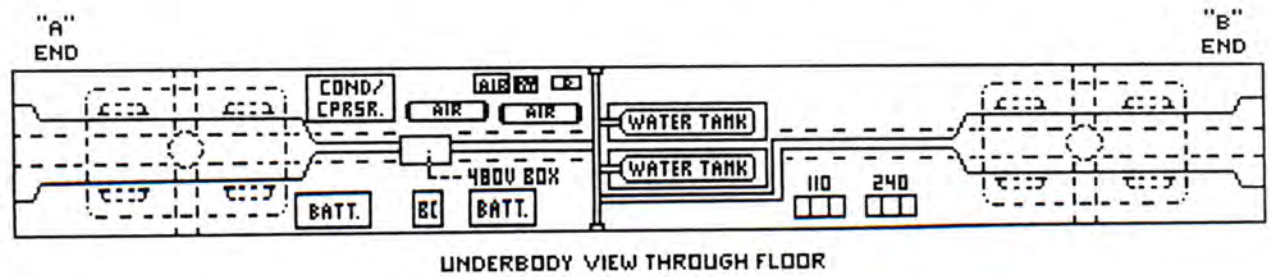
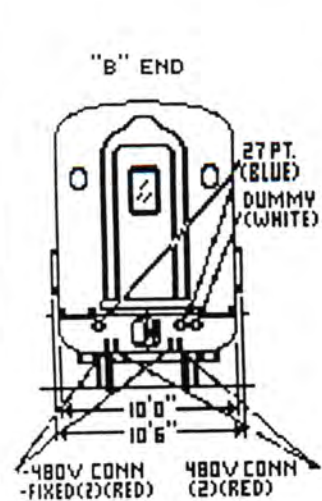
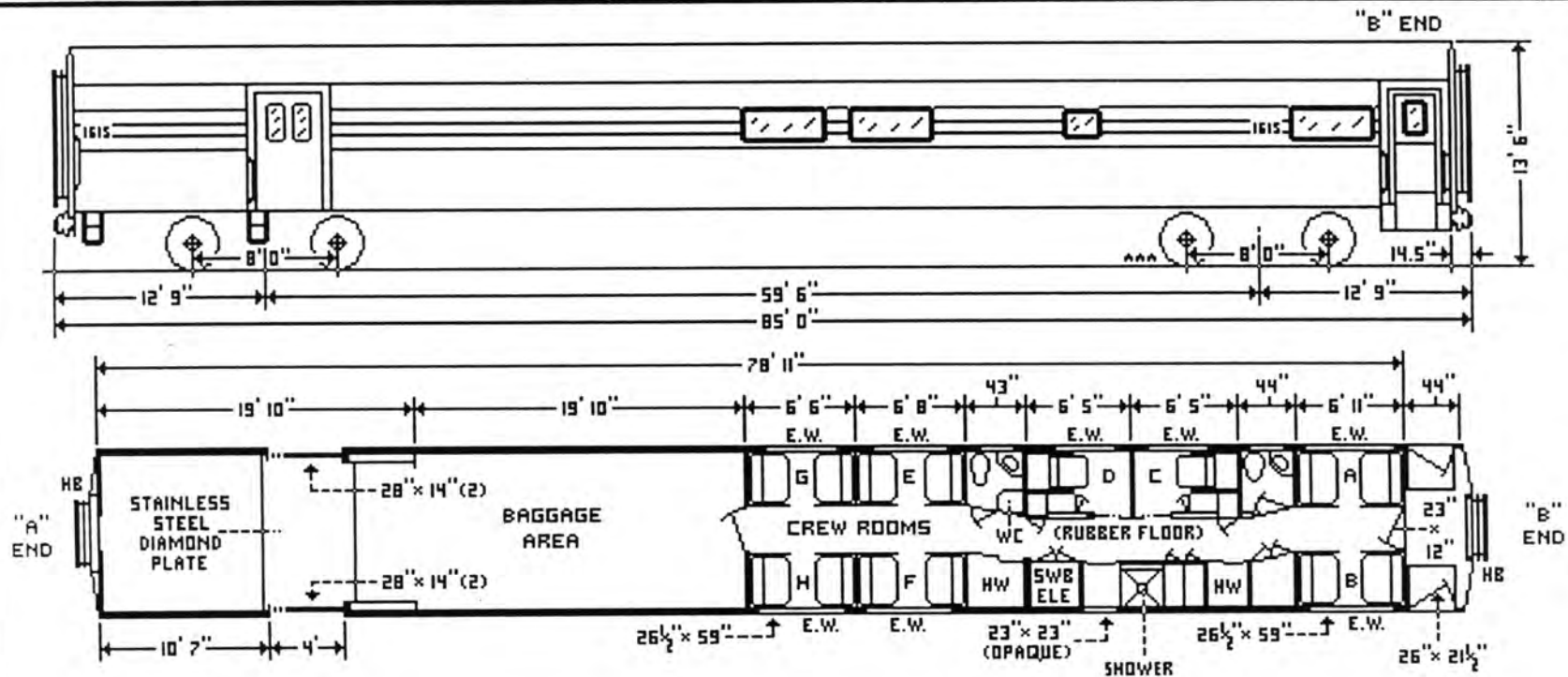

HERITAGE BAGGAGE-DORMITORY CAR

Equipment Code: BM

110 MPH

Car Numbers: 1626, 1627

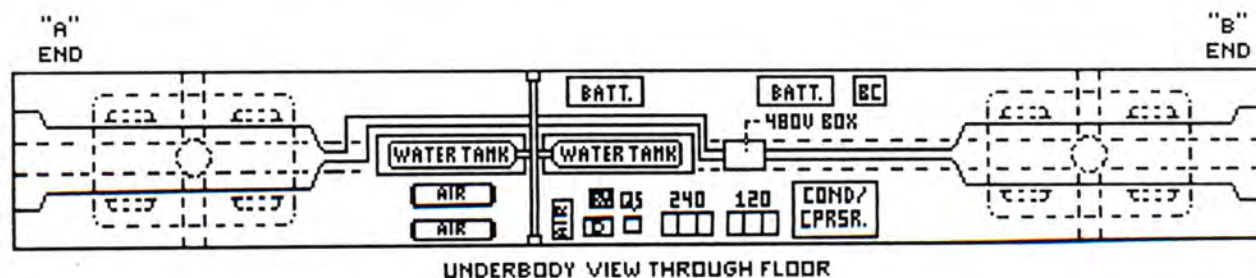
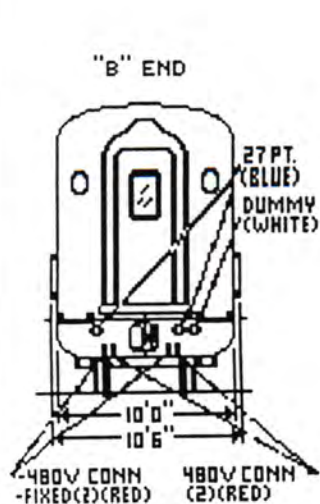
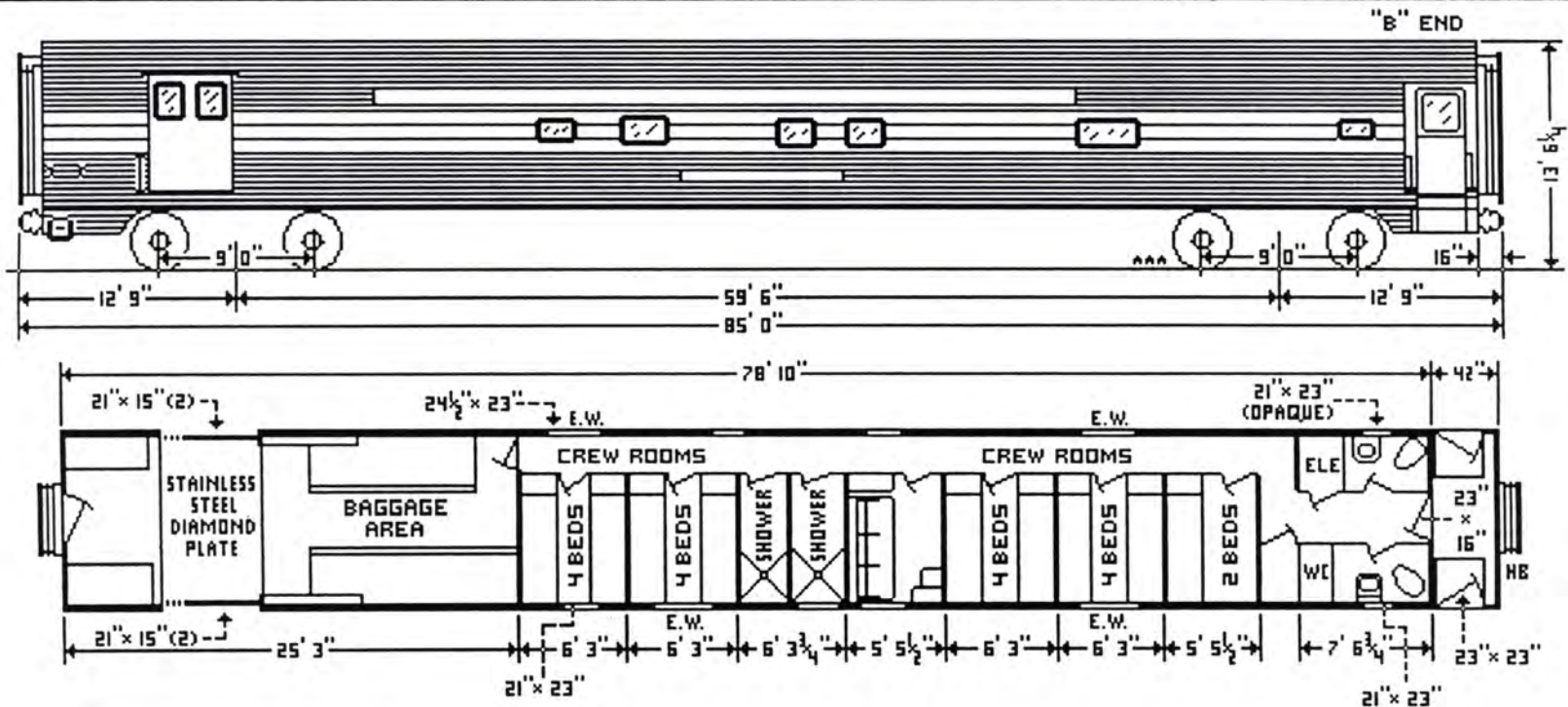

HERITAGE BAGGAGE CAR

Equipment Code: BA

110 MPH

Car Numbers: 1701, 1728-1739

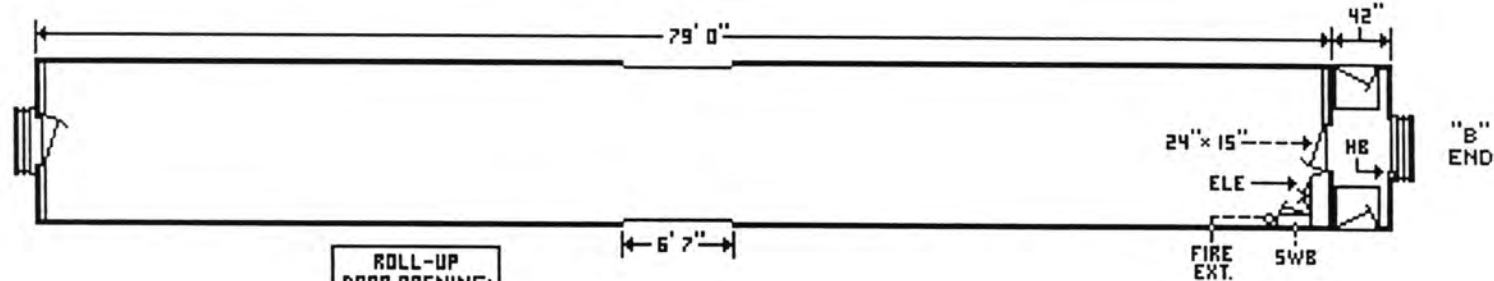
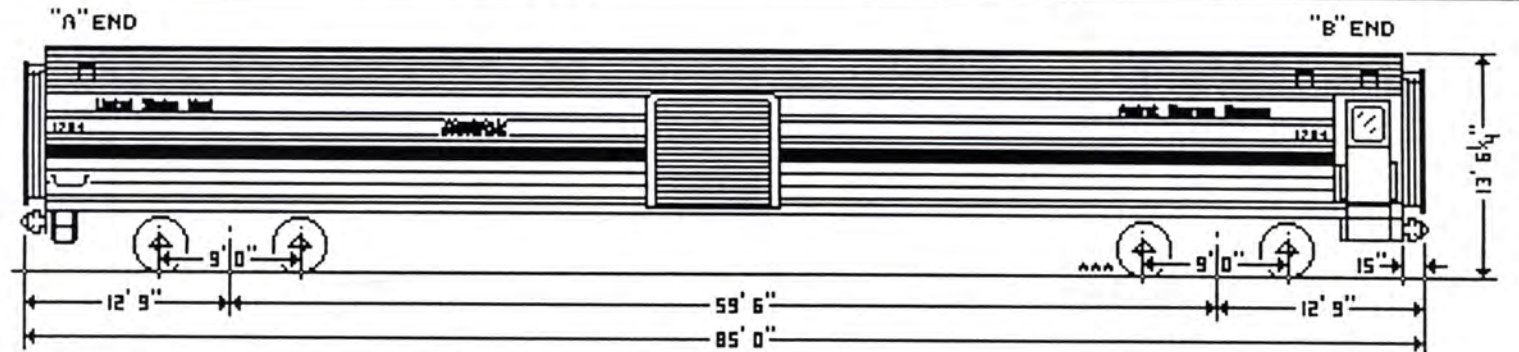

ROLL-UP
DOOR OPENING:
HEIGHT: 6' 2"
WIDTH: 6' 7"

1739: M.U. EQUIPPED FOR PUSH-PULL OPERATION

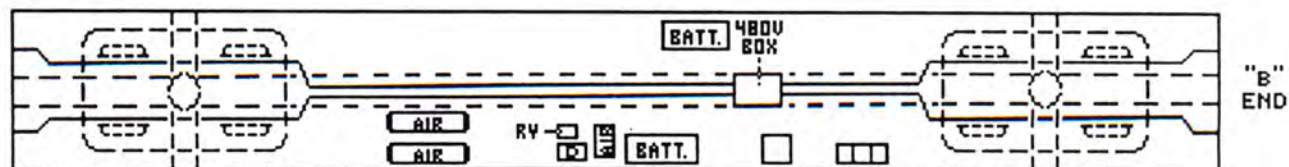
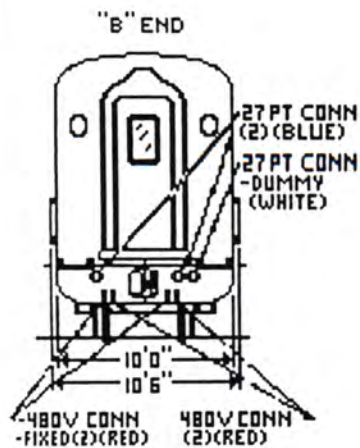

UNDERBODY VIEW THROUGH FLOOR

HERITAGE BAGGAGE CAR

Equipment Code: BA

110 MPH

Car Numbers: 1702-1720

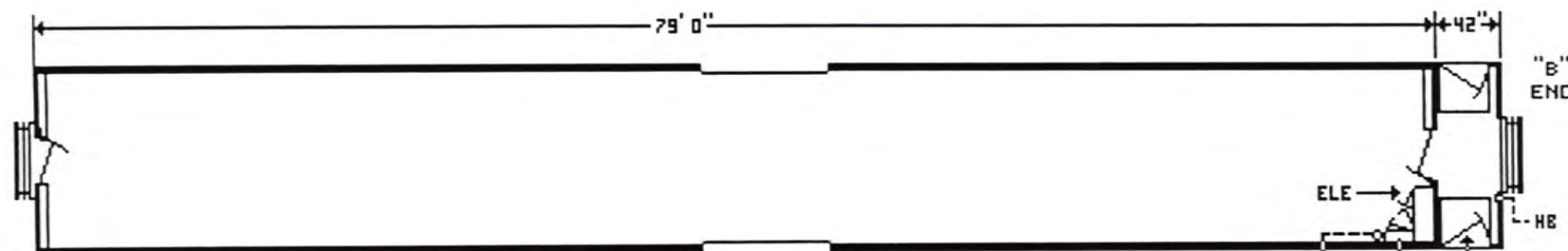
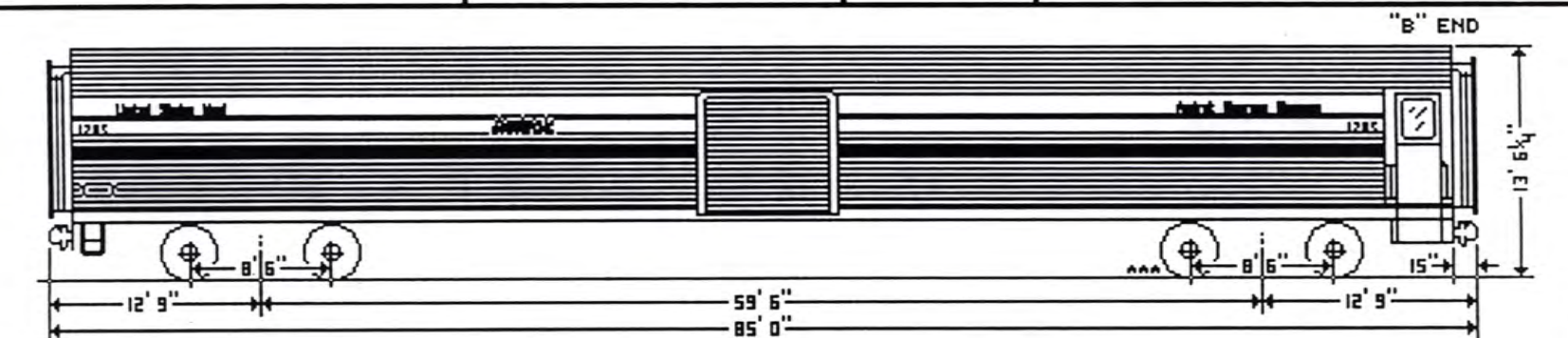

ROLL-UP
DOOR OPENING:
HEIGHT: 6' 2"
WIDTH: 6' 7"

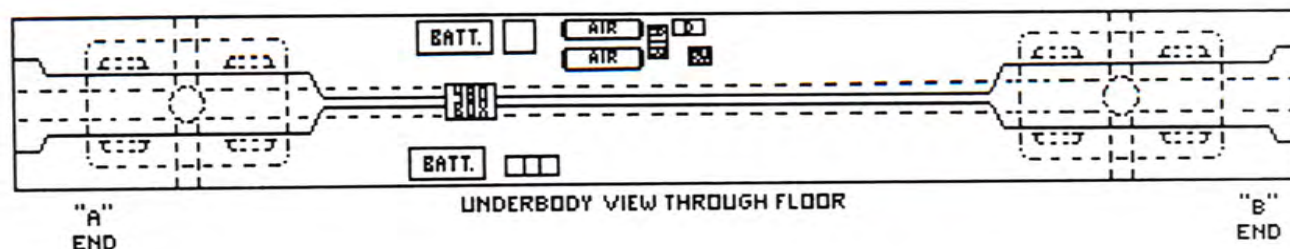
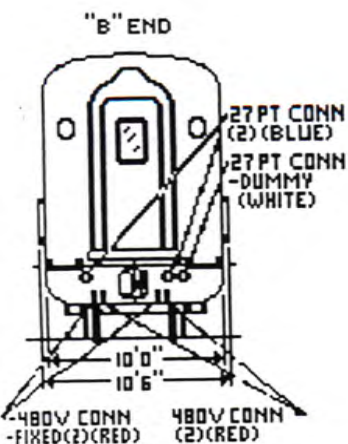

HERITAGE BAGGAGE CAR

Equipment Code: BA

110 MPH

Car Numbers: 1721-1727

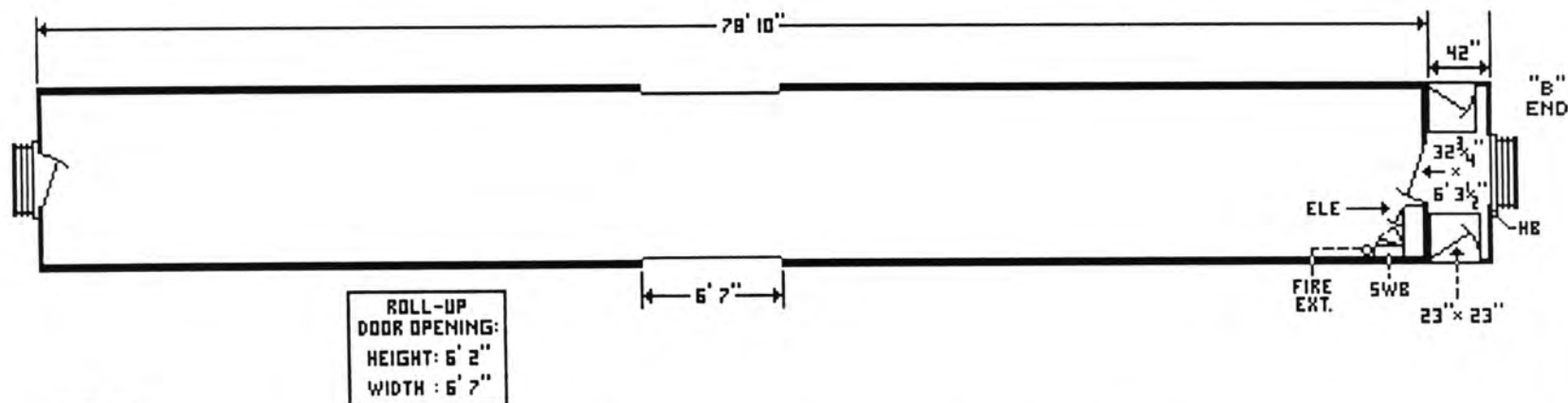
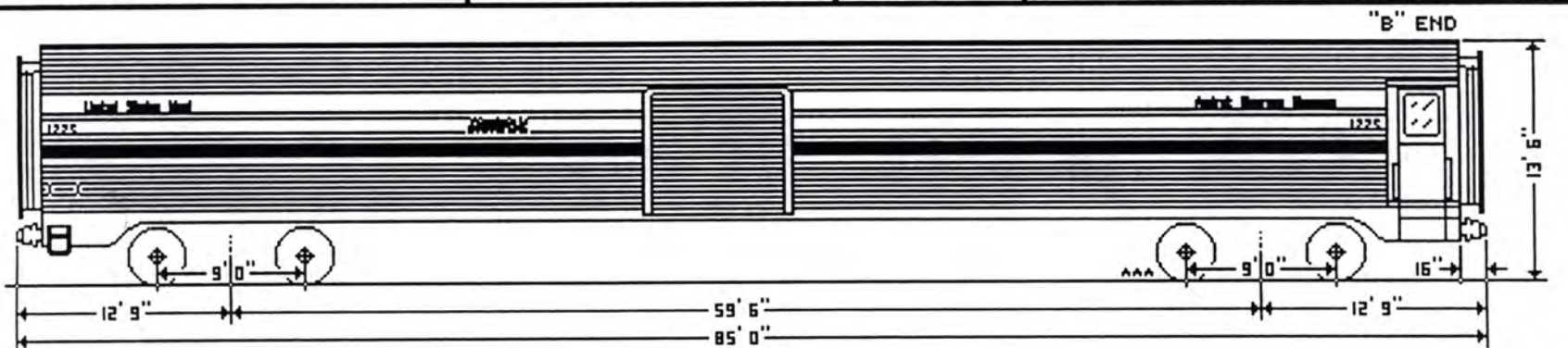

ROLL-UP
DOOR OPENING:
HEIGHT: 6' 2"
WIDTH: 6' 7"

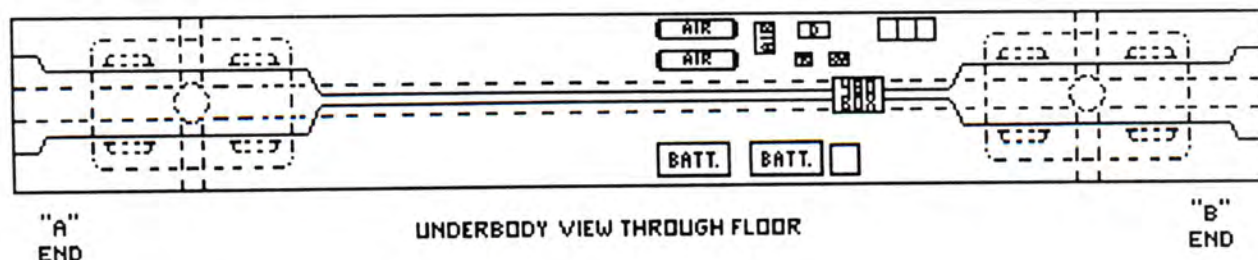
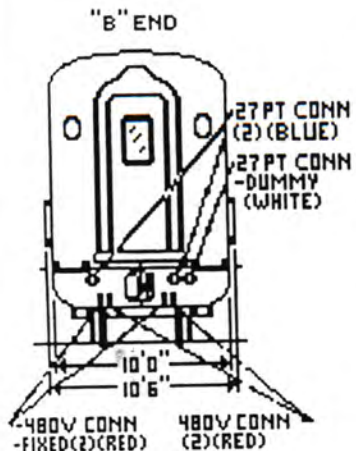

HERITAGE BAGGAGE CAR

Equipment Code: BA

110 MPH

Car Number: 1740

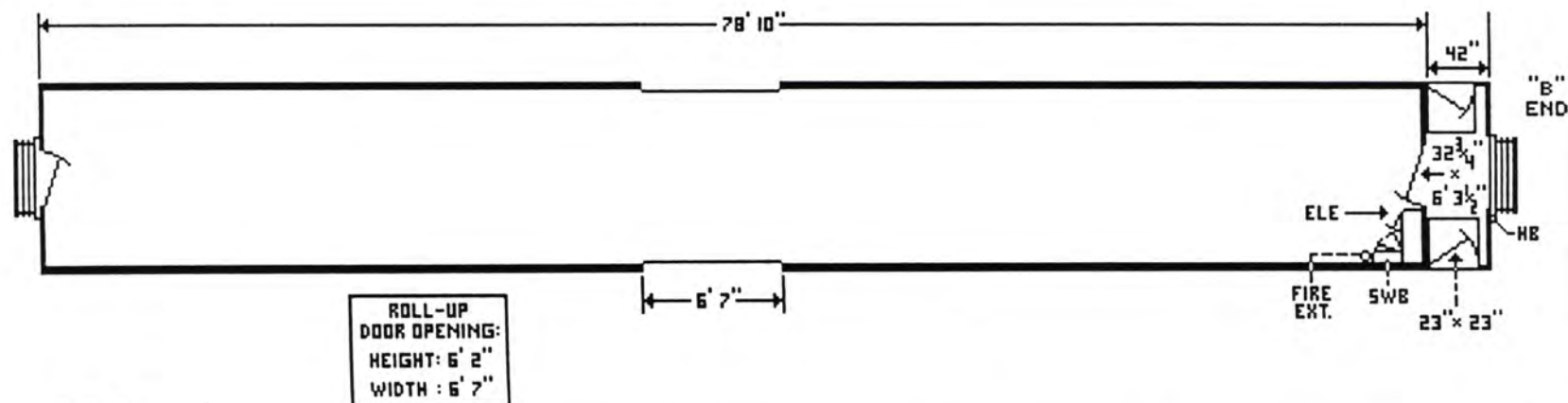
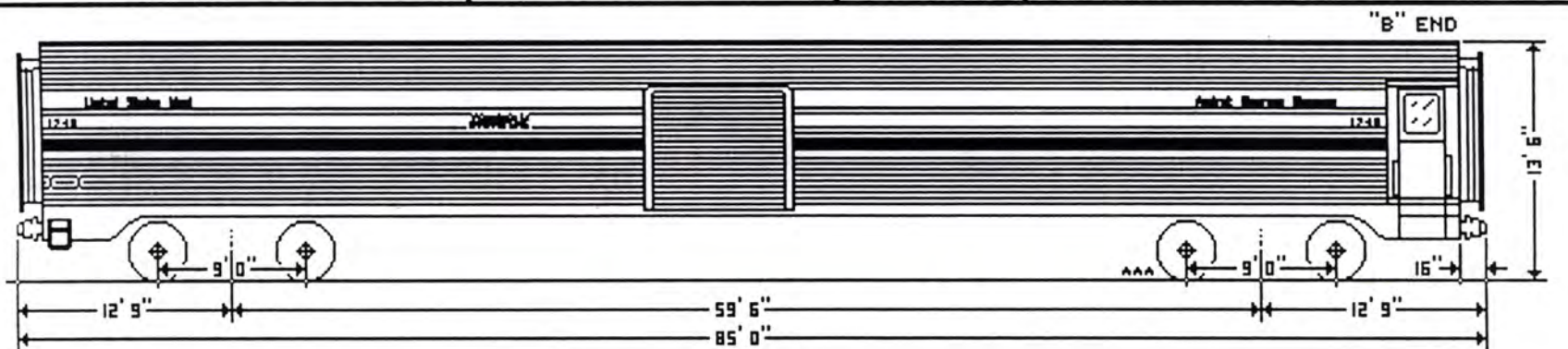

ROLL-UP
DOOR OPENING:
HEIGHT: 6' 2"
WIDTH: 6' 7"

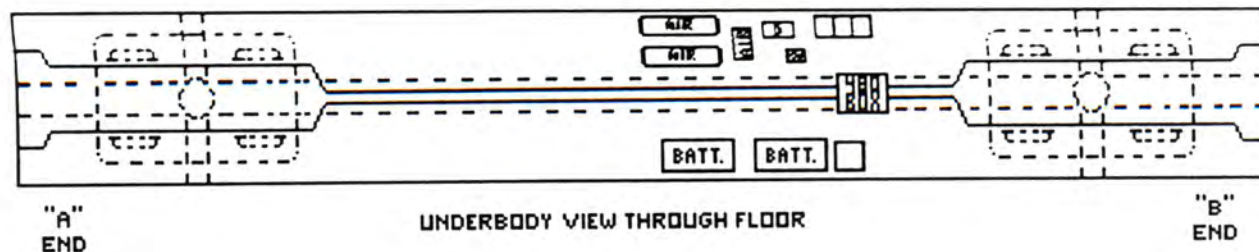
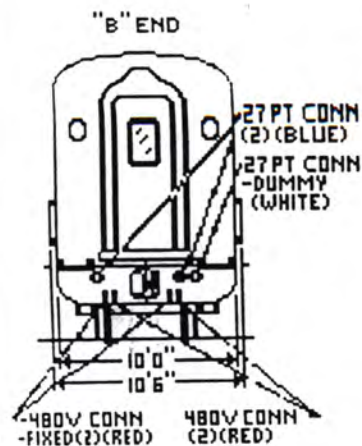

HERITAGE "VERMONT" BAGGAGE CAR

Eqpt. Code: BA

110 MPH

Car Numbers: 1800-1801

CAR IS M.U. EQUIPPED FOR PUSH-PULL OPERATION.

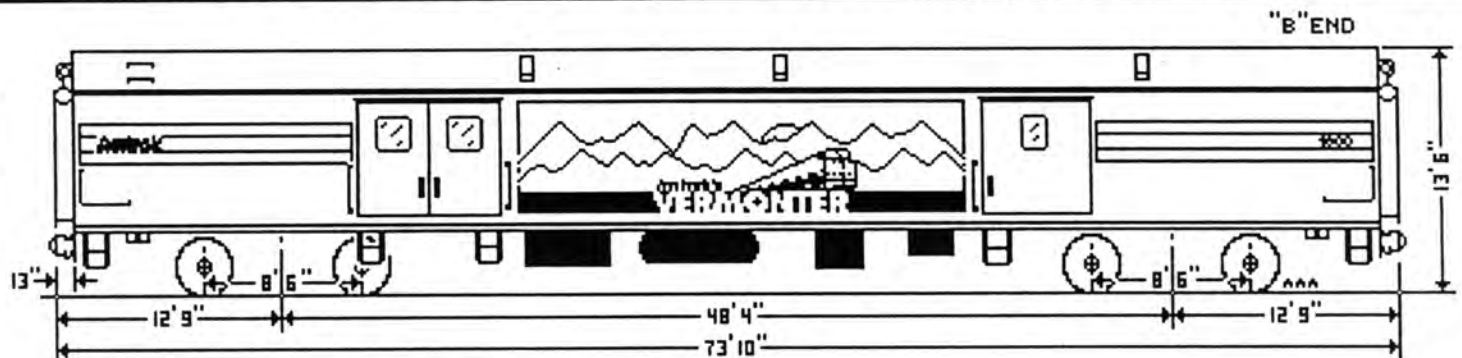

EACH SKI/BIKE RACK UNIT HOLDS 8 PAIRS OF SKIS / 5 BICYCLES.

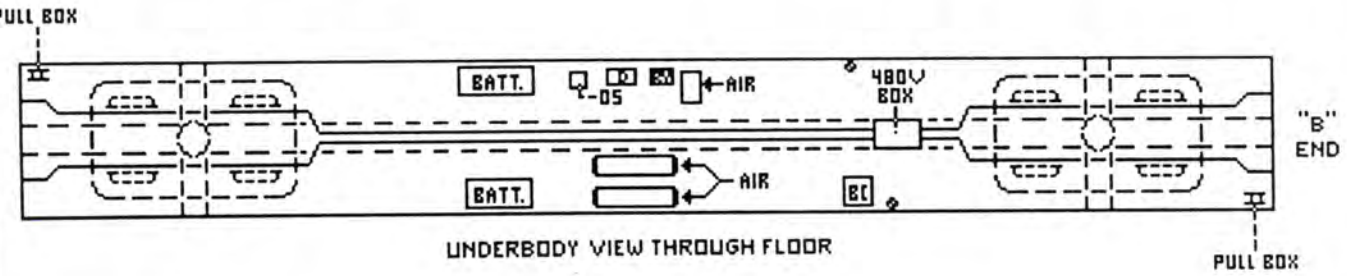
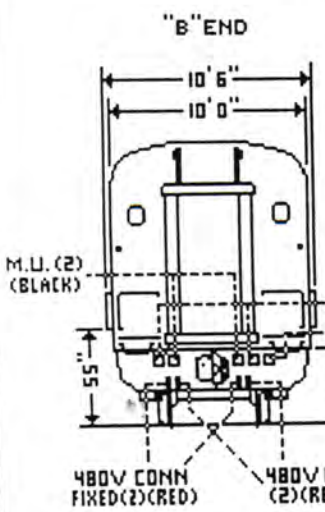
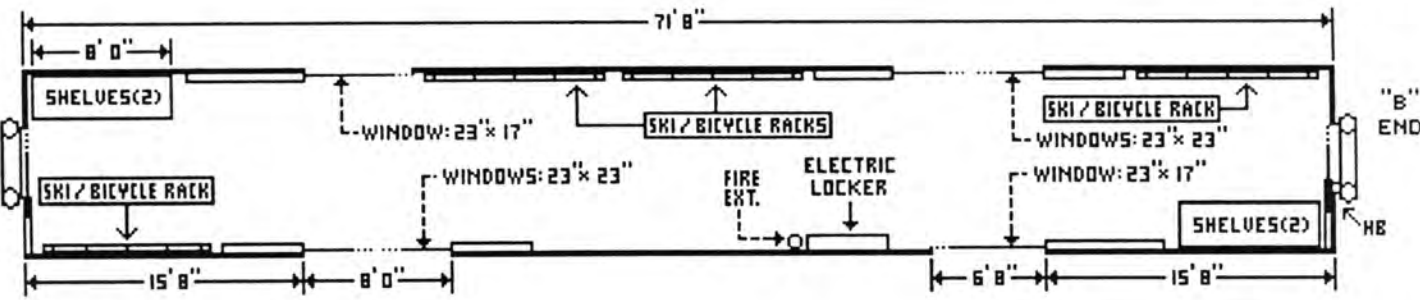

FORMER NUMBERS: 1136, 1175

HERITAGE "VERMONT" BAGGAGE CAR

Equipment Code: BA

110 MPH

Car Number : 1802

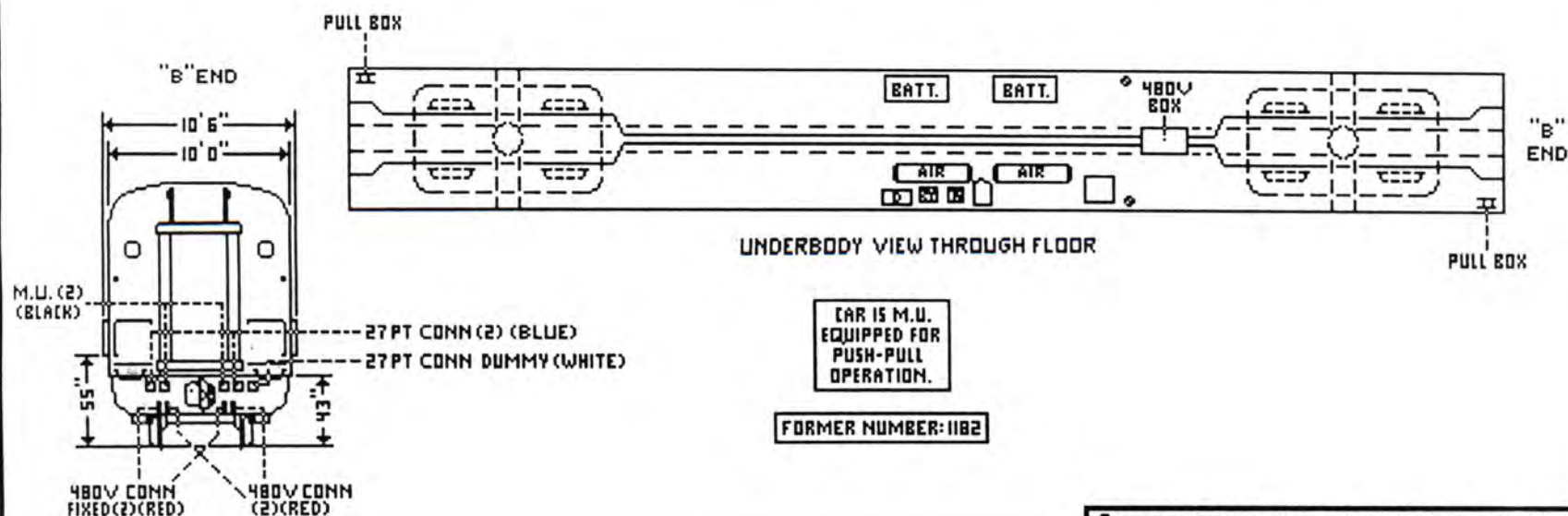
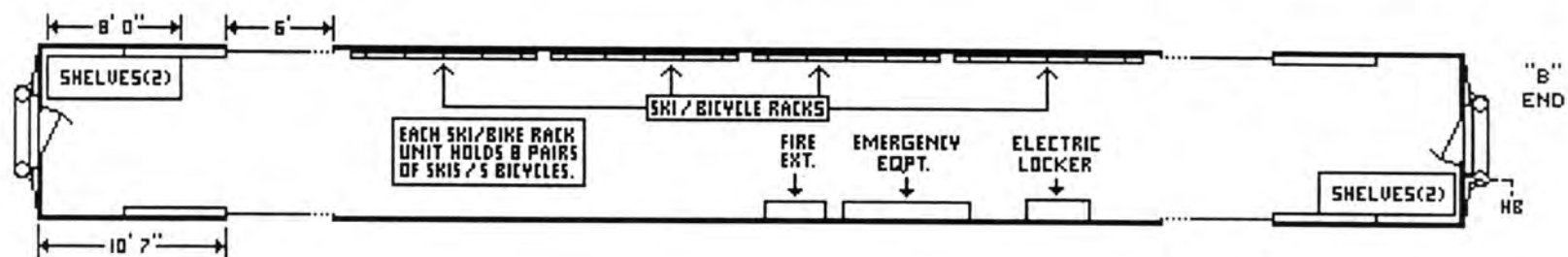
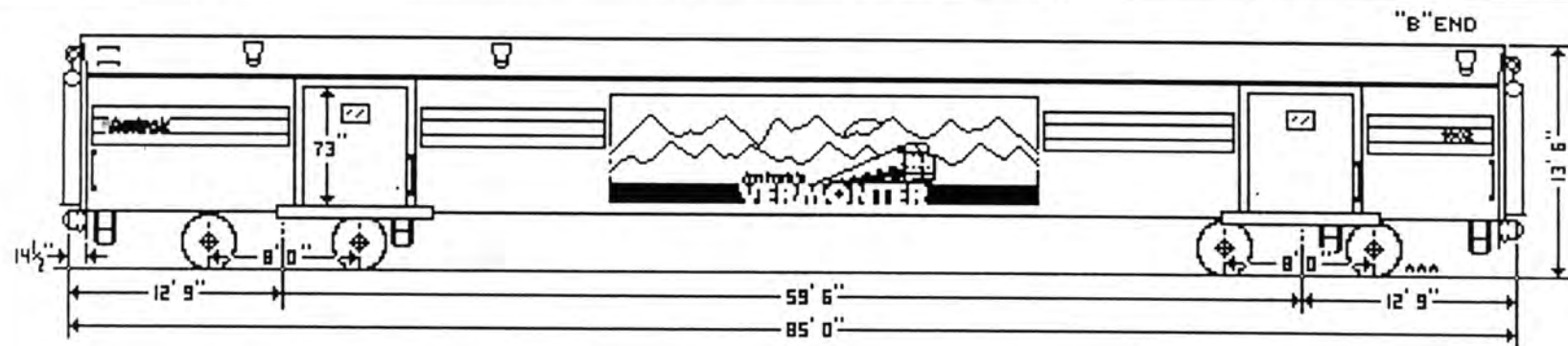

HERITAGE 16-10 SLUMBERCOACH

Eqpt. Code: SU

110 MPH

Car Numbers: 2050-2055

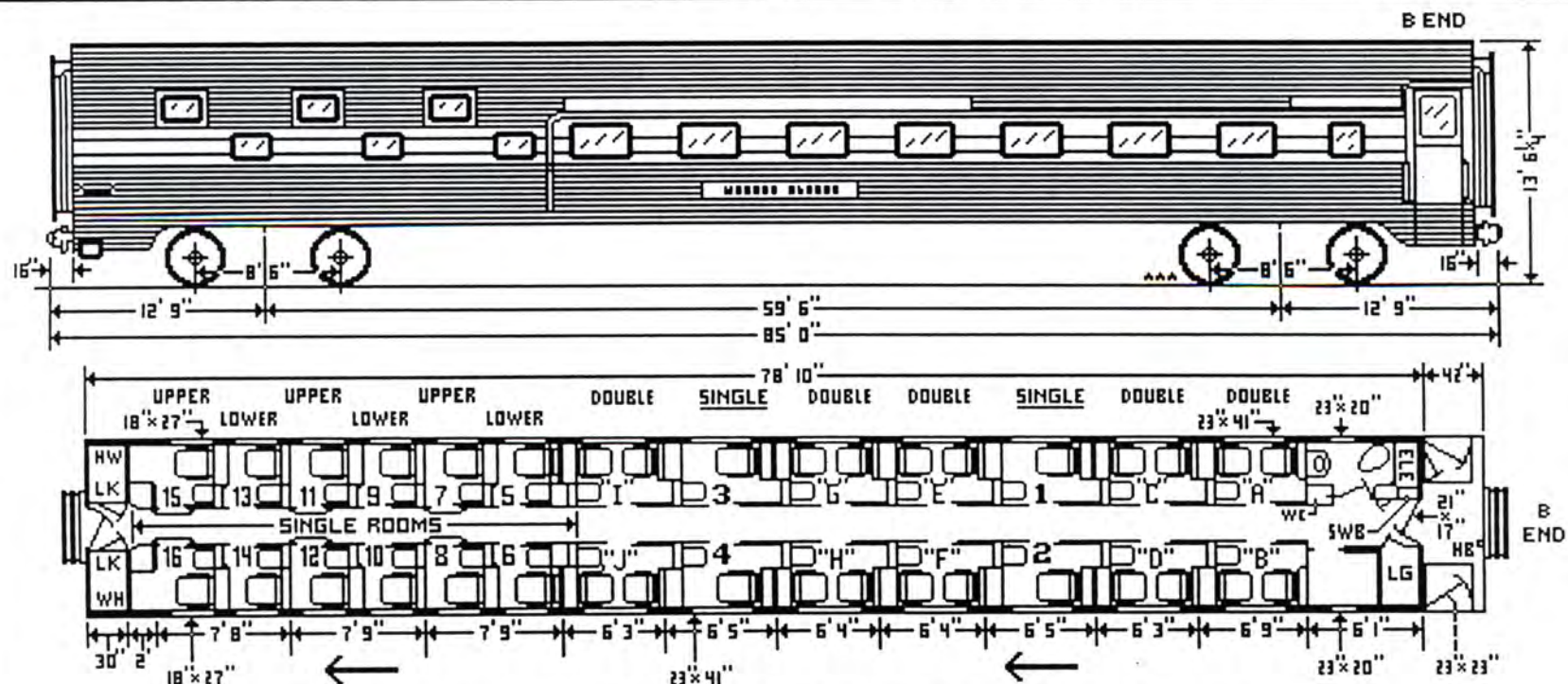

NOTE: SINGLE ROOMS 1-4 ARE LARGE FLOOR-LEVEL SINGLES NESTED BETWEEN DOUBLES. SINGLE ROOMS 5-16 ALTERNATE UPPER AND LOWER AS SHOWN.

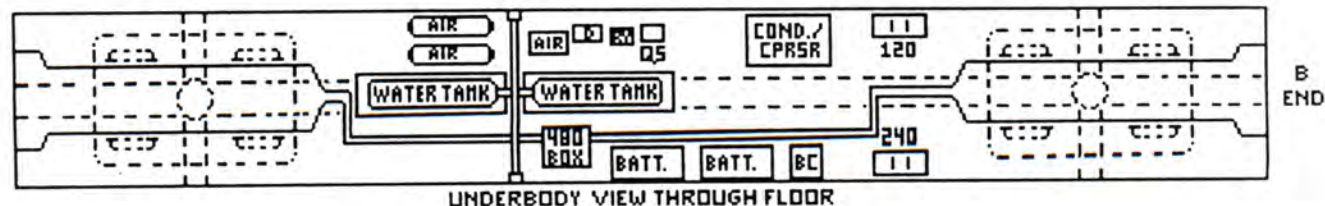
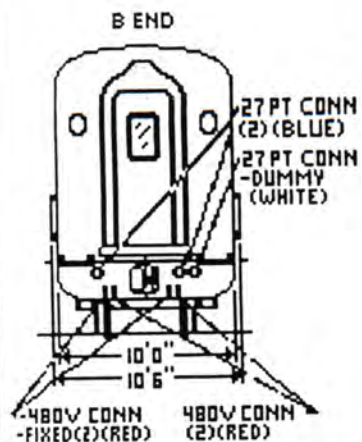

2050 - MONROE HARBOR 2054 - SOUTH HAVEN HARBOR
 2051 - FAIRPORT HARBOR 2055 - TOLEDO HARBOR
 2052 - DUNKIRK HARBOR

HERITAGE 24-8 SLUMBERCOACH

Eqpt. Code: SU

110 MPH

Car Numbers: 2080-2095

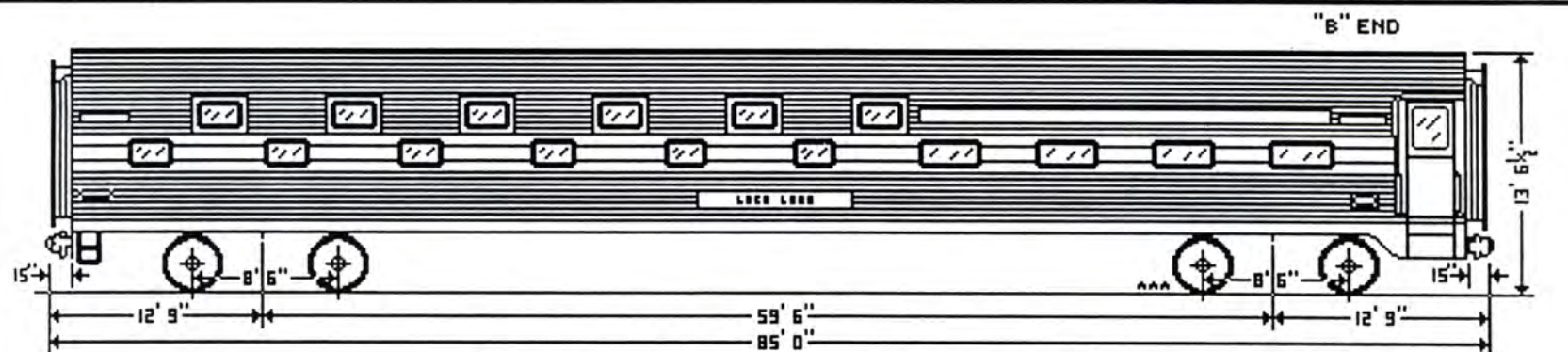

NOTE: SINGLE ROOMS ALTERNATE UPPER AND LOWER AS SHOWN.

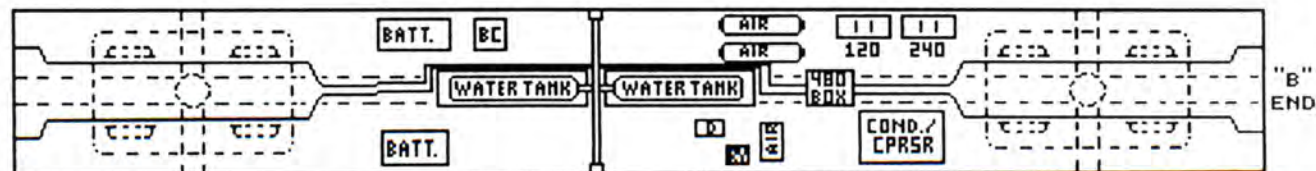
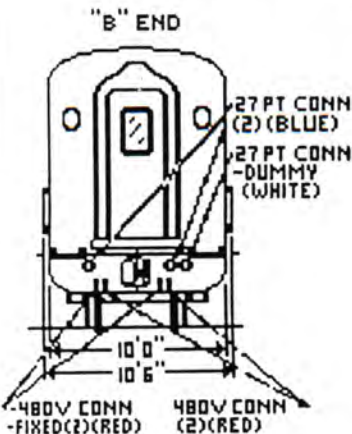
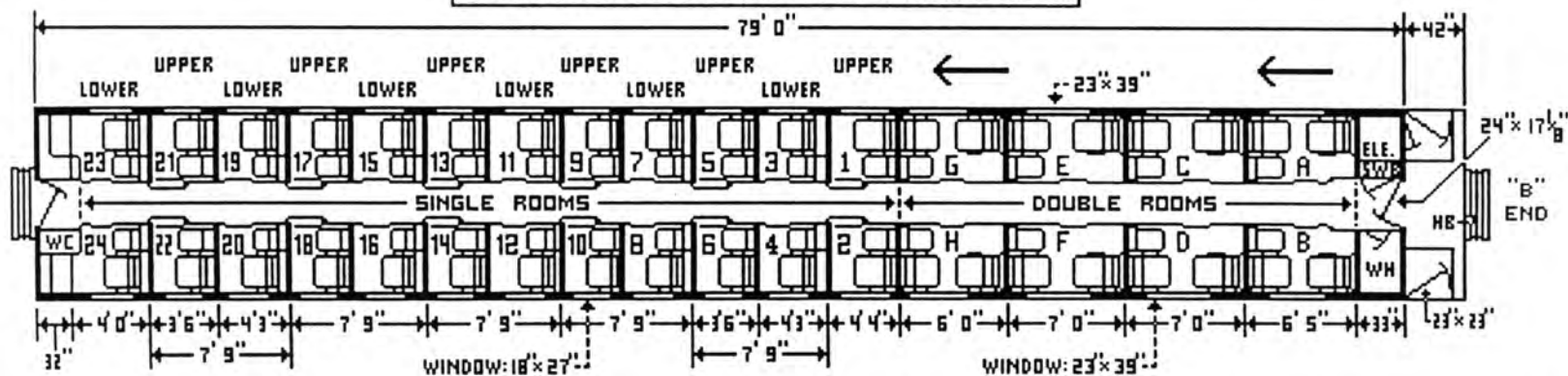

UNDERBODY VIEW THROUGH FLOOR

| | | |
|-----------------------|---------------------|----------------------|
| 2080 - LOCH SLOW | 2088 - LOCH LEVEN | 2094 - SILVER REST |
| 2081 - LOCH LONG | 2089 - LOCH TAY | 2095 - SILVER REPOSE |
| 2082 - LOCH RANNOCH | 2090 - LOCH TARBET | |
| 2084 - LOCH LOMUND | 2091 - LOCH LOCHY | |
| 2085 - SILVER SLUMBER | 2092 - LOCH ARKAIG | |
| 2087 - LOCH NESS | 2093 - LOCH KATRINE | |

HERITAGE 24-8 SLUMBERCOACH

Eqpt. Code: SU

110 MPH

Car Numbers: 2096-2097

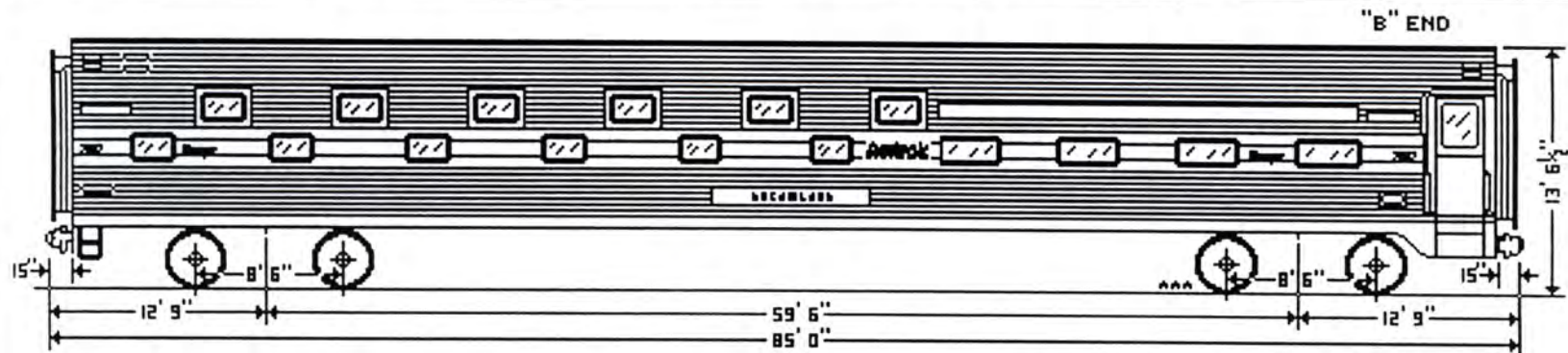

NOTE: SINGLE ROOMS ALTERNATE UPPER AND LOWER AS SHOWN.

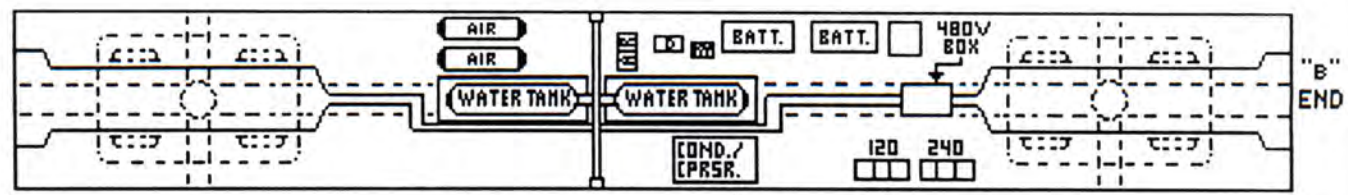
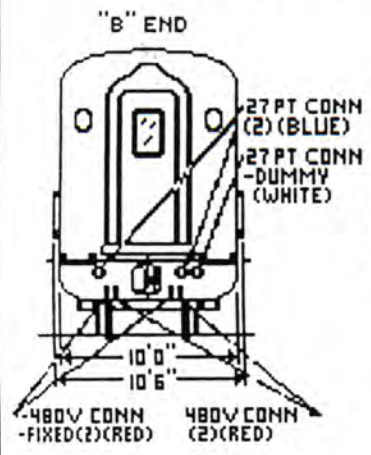
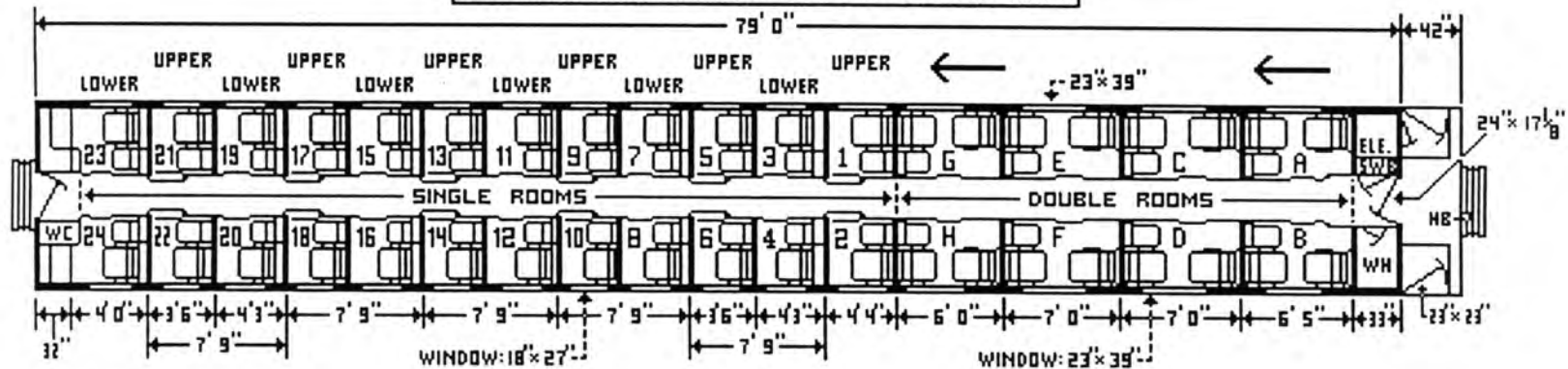

UNDERBODY VIEW THROUGH FLOOR

**2096 - SLUMBERLAND
2097 - DREAMLAND**

HERITAGE 11 BEDROOM SLEEPER

Eqpt. Code: SE

110 MPH

Car Numbers: 2220-2222

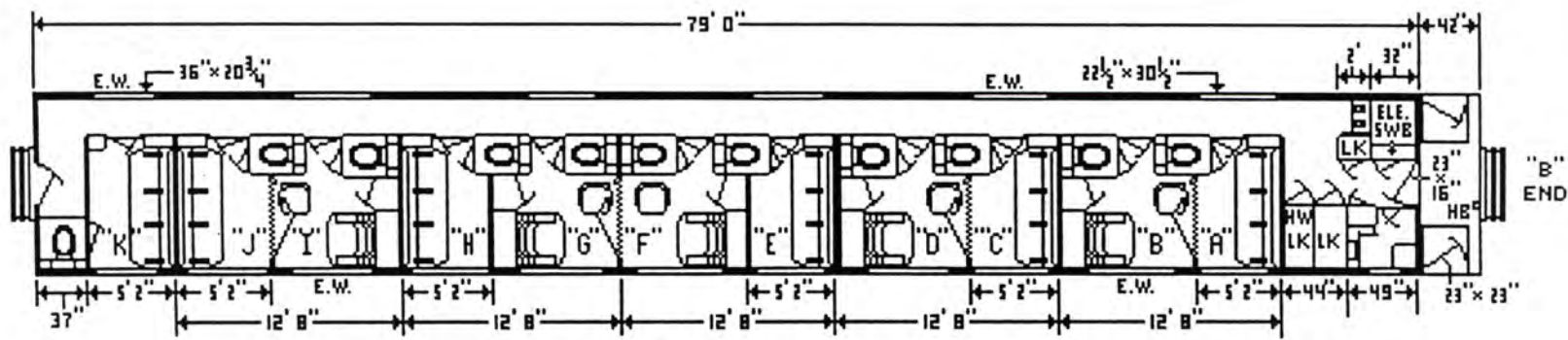
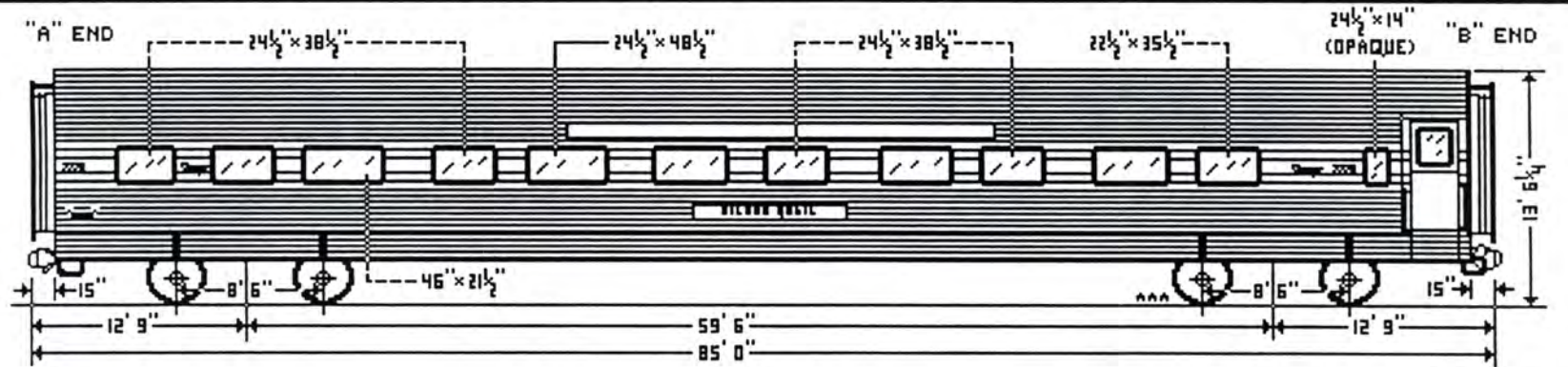

BEDROOM PAIRS "A" & "B", "C" & "D", "F" & "G", "I" & "J" MAY BE CONVERTED TO BEDROOM SUITES.

E.W. = EMERGENCY WINDOW

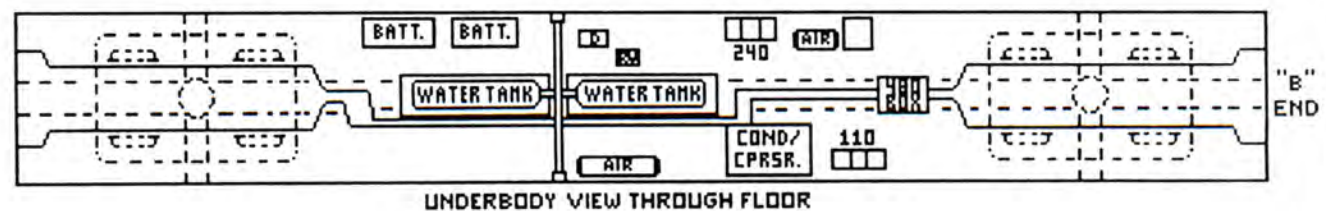
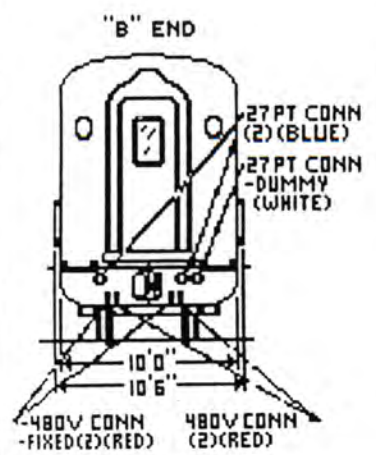

- 2220 - SILVER QUAIL
- 2221 - SILVER THRU
- 2222 - SILVER PELICAN

HERITAGE 11 BEDROOM SLEEPER

Eqpt. Code: SE

110 MPH

Car Numbers: 2230-2234

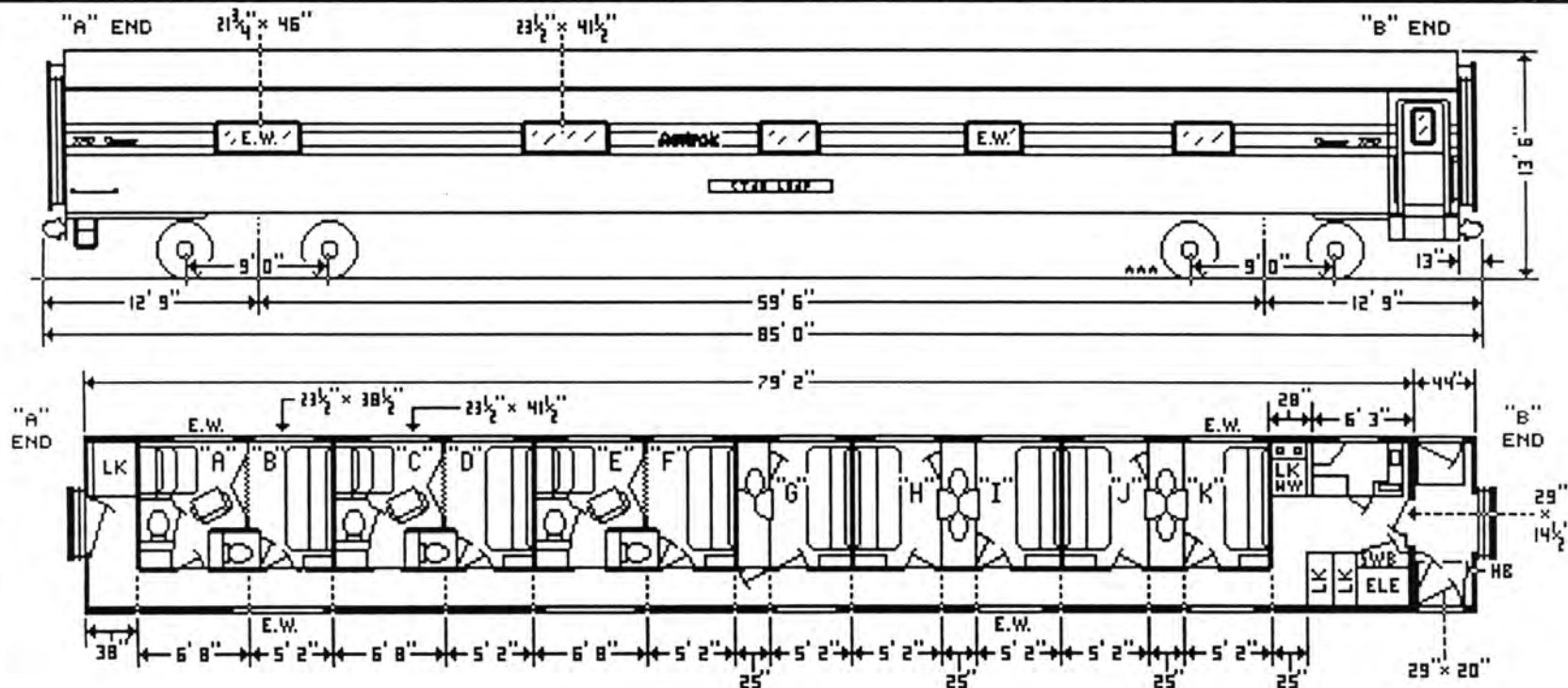

BEDROOM PAIRS "A" & "B", "C" & "D", "E" & "F" MAY BE CONVERTED TO BEDROOM SUITES.

E.W. = EMERGENCY WINDOW

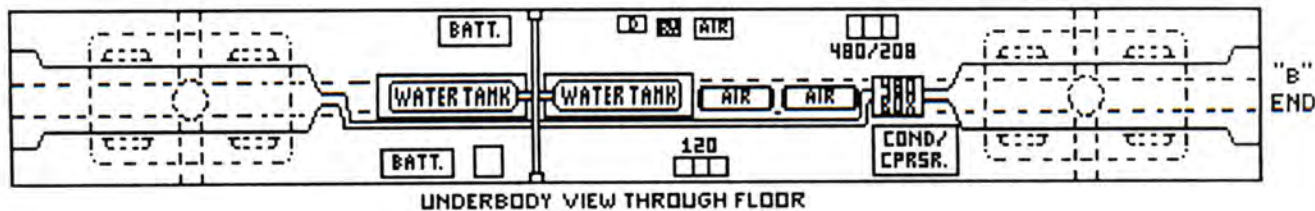
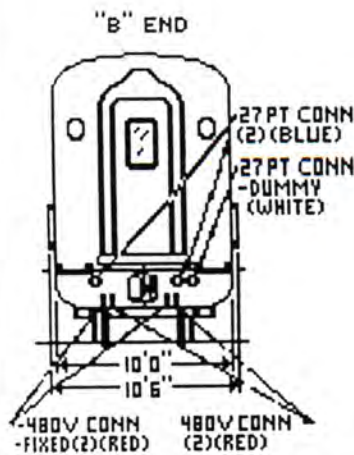

- | | |
|-------------------|-------------------|
| 2230 - STAR BAY | 2233 - STAR RANGE |
| 2231 - STAR CREST | 2234 - STAR SCENE |
| 2232 - STAR LEAF | |

HERITAGE 11 BEDROOM SLEEPER

Eqpt. Code: SE

110 MPH

Car Number: 2235

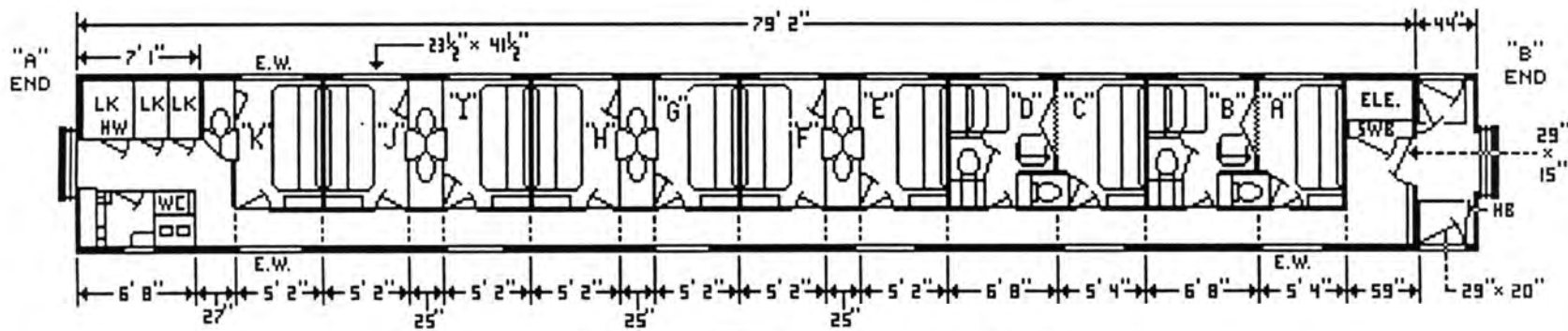
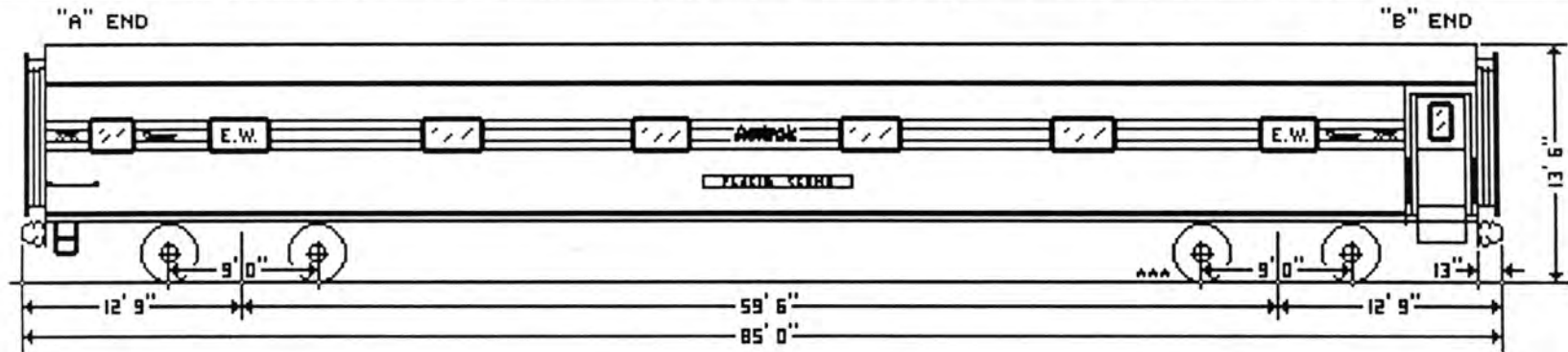

BEDROOM PAIRS "A" & "B" AND "C" & "D" MAY BE CONVERTED TO BEDROOM SUITES.

E.W. = EMERGENCY WINDOW

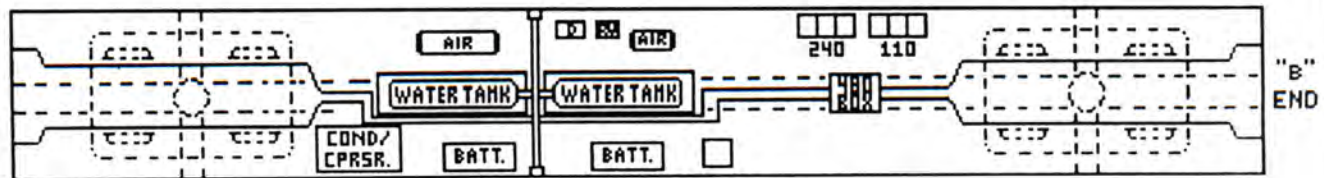
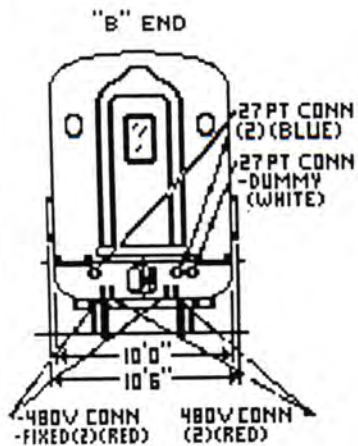

UNDERBODY VIEW THROUGH FLOOR

2235 - PLACID SCENE

VIEWLINER SLEEPING CAR (PROTOTYPE)

Equipment Code: VS

110 MPH

Car Number: 2301

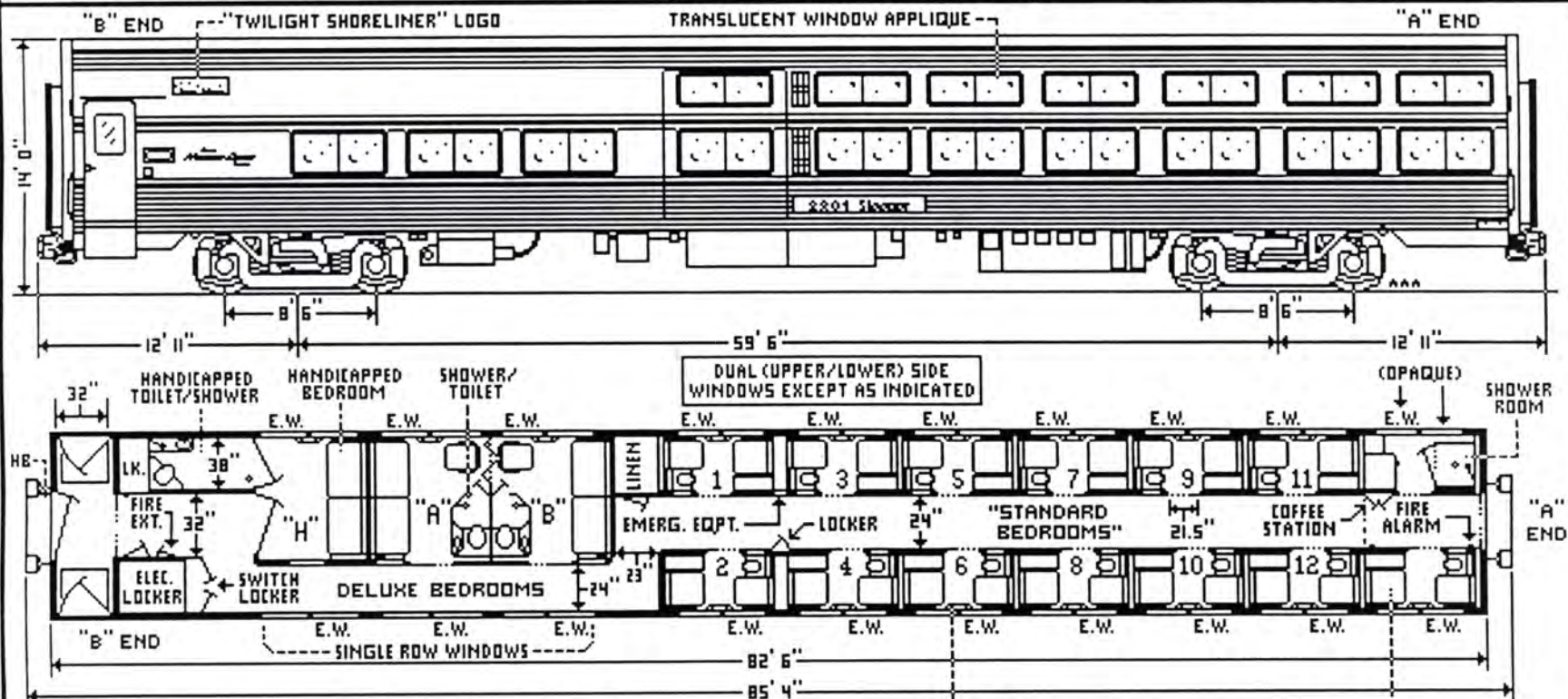

BEDROOMS "A" & "B" MAY BE CONVERTED TO A BEDROOM SUITE.

"STANDARD BEDROOMS" WERE FORMERLY CALLED "COMPARTMENTS"

ATTENDANT'S ROOM

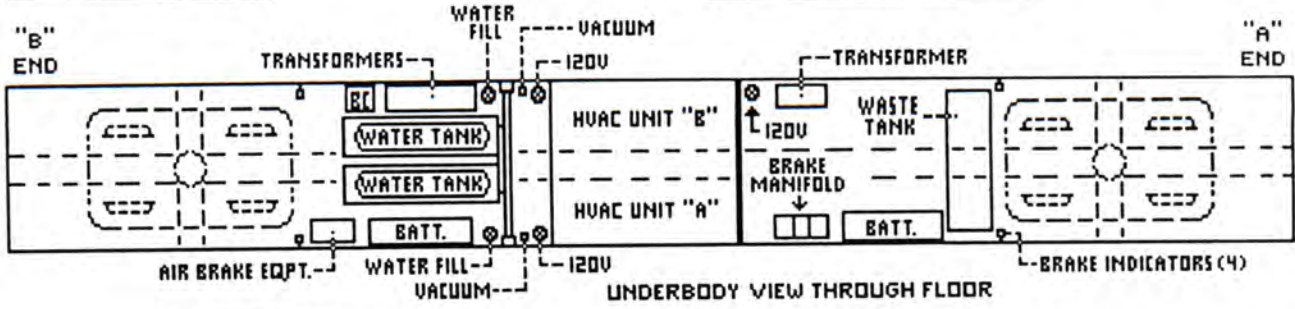
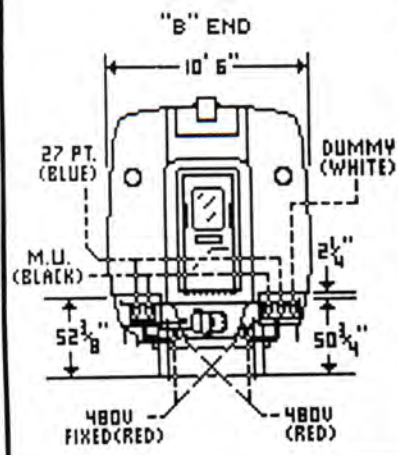

NO AUDIO/VIDEO EQUIPMENT IN THIS CAR.

HERITAGE HANDICAPPED 10-6 SLEEPER

Eqpt. Code: SH

110 MPH

Car Numbers: 2430-2441

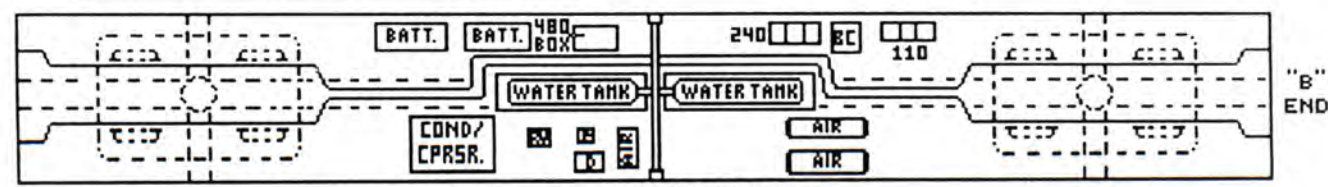
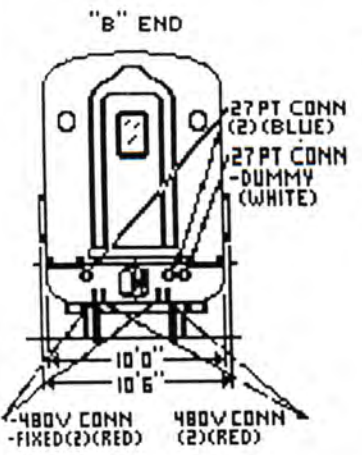
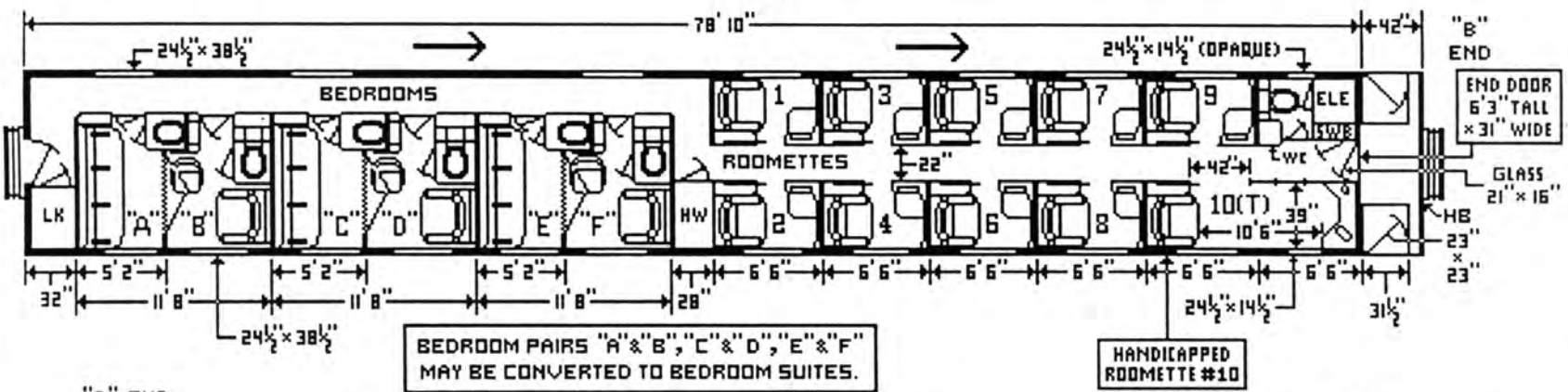
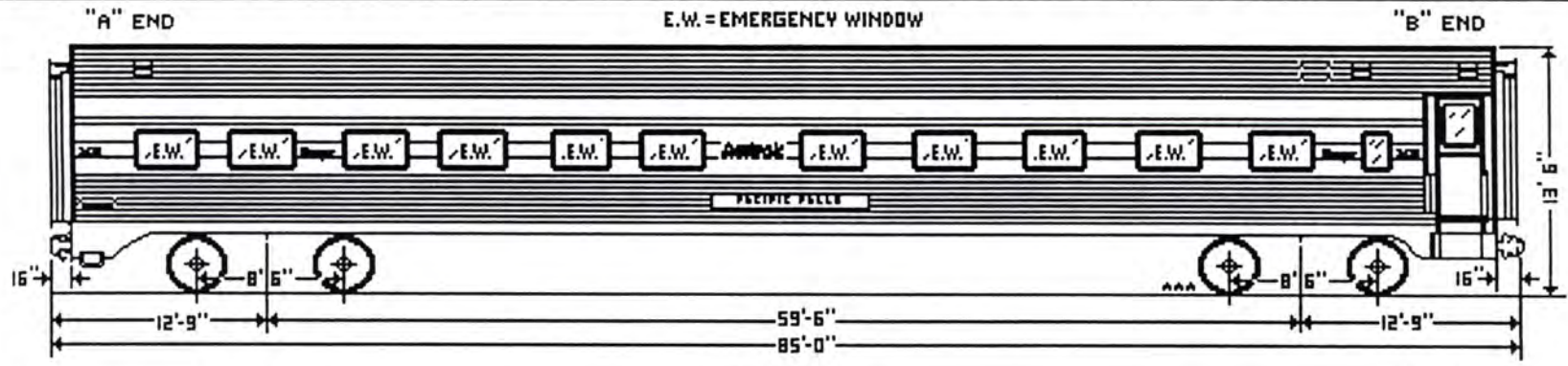

UNDERBODY VIEW THROUGH FLOOR

- | | |
|-------------------------|-----------------------|
| 2430 - PACIFIC FALLS | 2437 - PACIFIC OCEAN |
| 2431 - PACIFIC FORUM | 2438 - PACIFIC CASTLE |
| 2432 - PACIFIC WAVES | 2439 - PACIFIC LODGE |
| 2434 - PACIFIC PLATERAU | 2440 - PACIFIC BEACH |
| 2435 - PACIFIC MEADOW | 2441 - PACIFIC COVE |
| 2436 - PACIFIC CREST | |

HERITAGE HANDICAPPED 10-6 SLEEPER

Eqpt. Code: SH

110 MPH

Car Numbers: 2442-2456

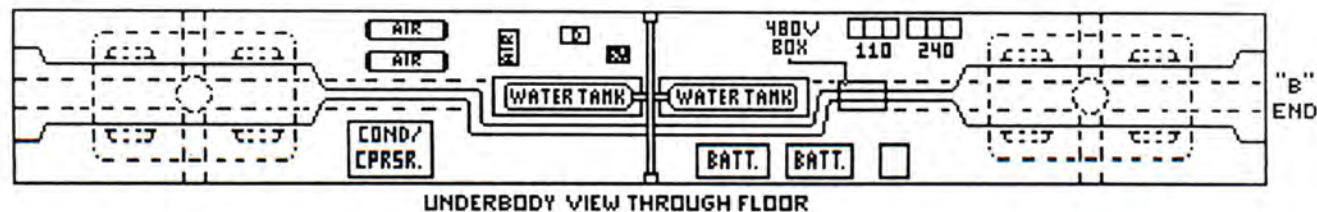
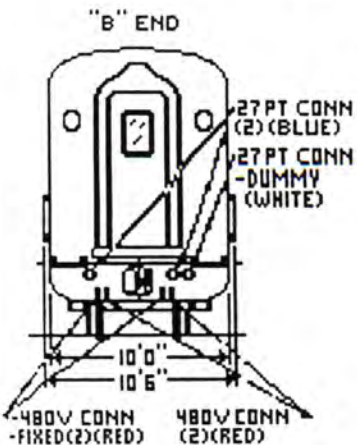
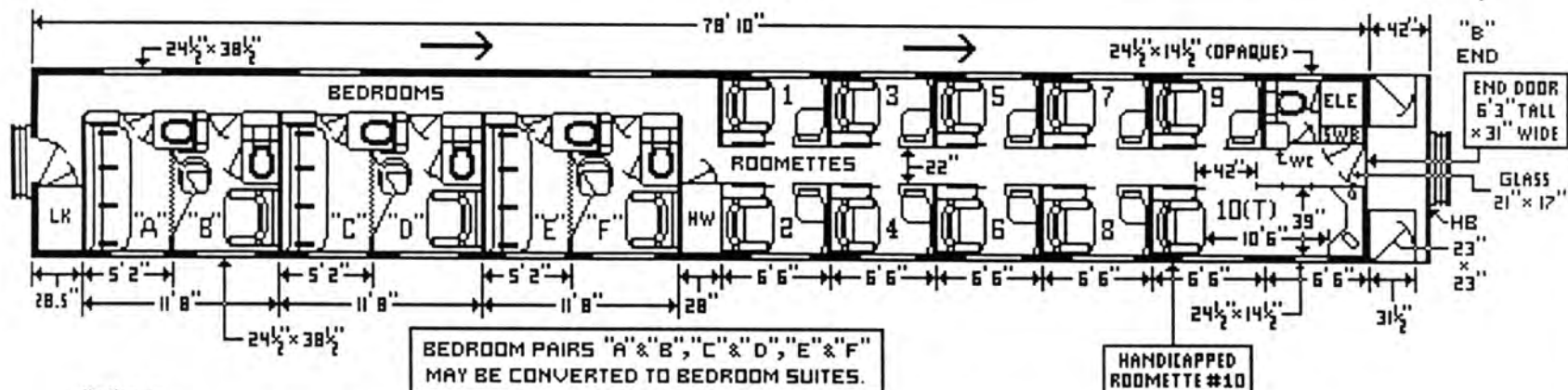
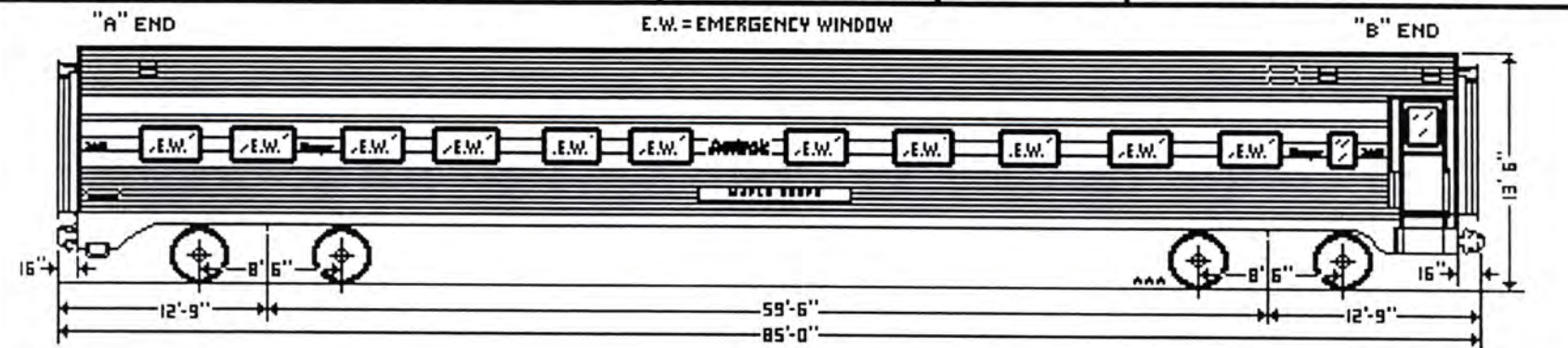

| | |
|-----------------------|---------------------|
| 2444 - MAGNOLIA GROVE | 2449 - MAPLE GROVE |
| 2446 - CYPRESS GROVE | 2450 - BEECH GROVE |
| 2447 - SYCAMORE GROVE | 2455 - ELM GROVE |
| 2448 - OAK GROVE | 2456 - WILLOW GROVE |

HERITAGE HANDICAPPED 10-6 SLEEPER

Eqpt. Code: SH

110 MPH

Car Numbers: 2457-2460

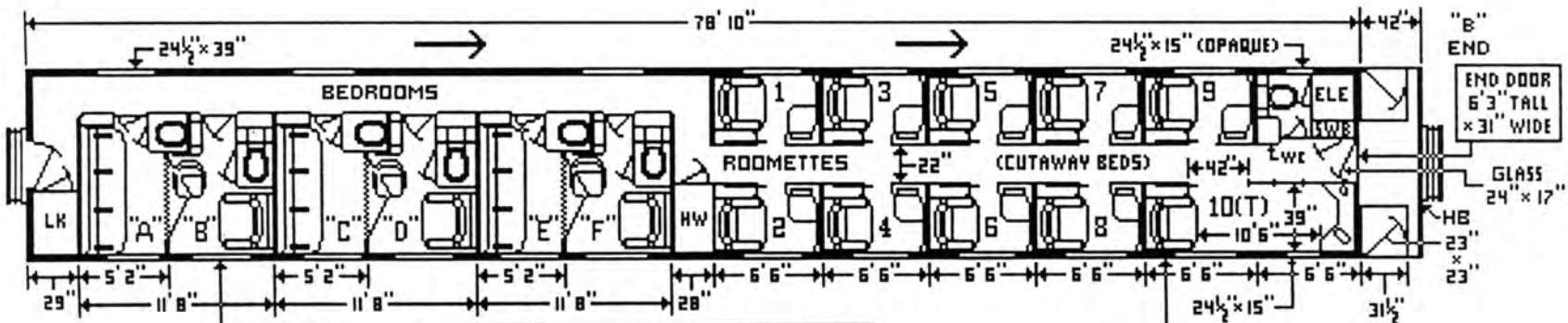
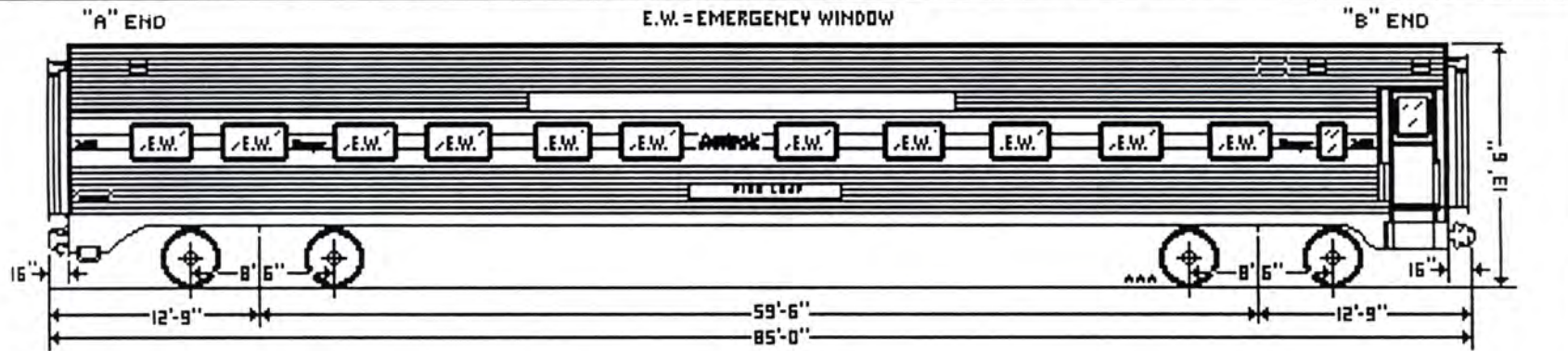

BEDROOM PAIRS "A" & "B", "C" & "D", "E" & "F" MAY BE CONVERTED TO BEDROOM SUITES.

HANDICAPPED ROOMETTE #10

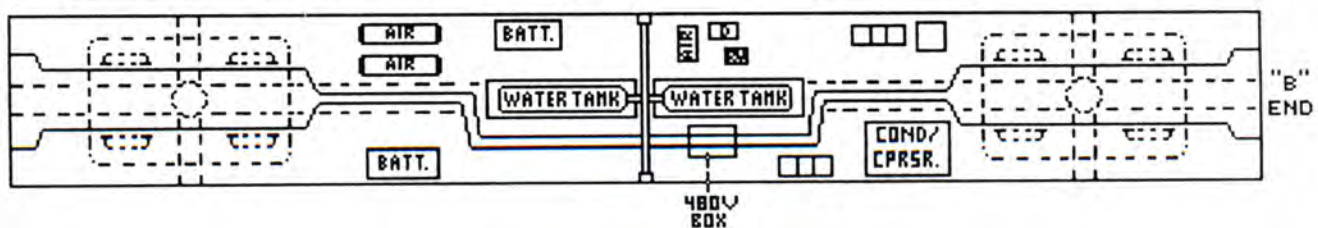
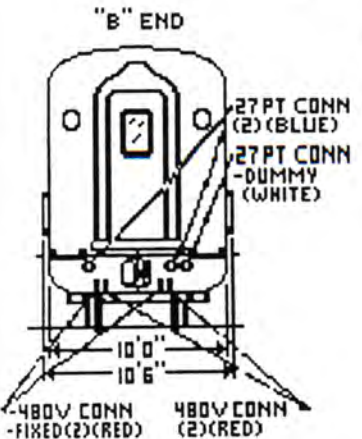

UNDERBODY VIEW THROUGH FLOOR

- 2457 - PINE PASS
- 2458 - PINE LEAF
- 2459 - PINE DAWN
- 2460 - PINE ISLAND

HERITAGE HANDICAPPED 10-6 SLEEPER

Eqpt. Code: SH

110 MPH

Car Numbers: 2461-2467

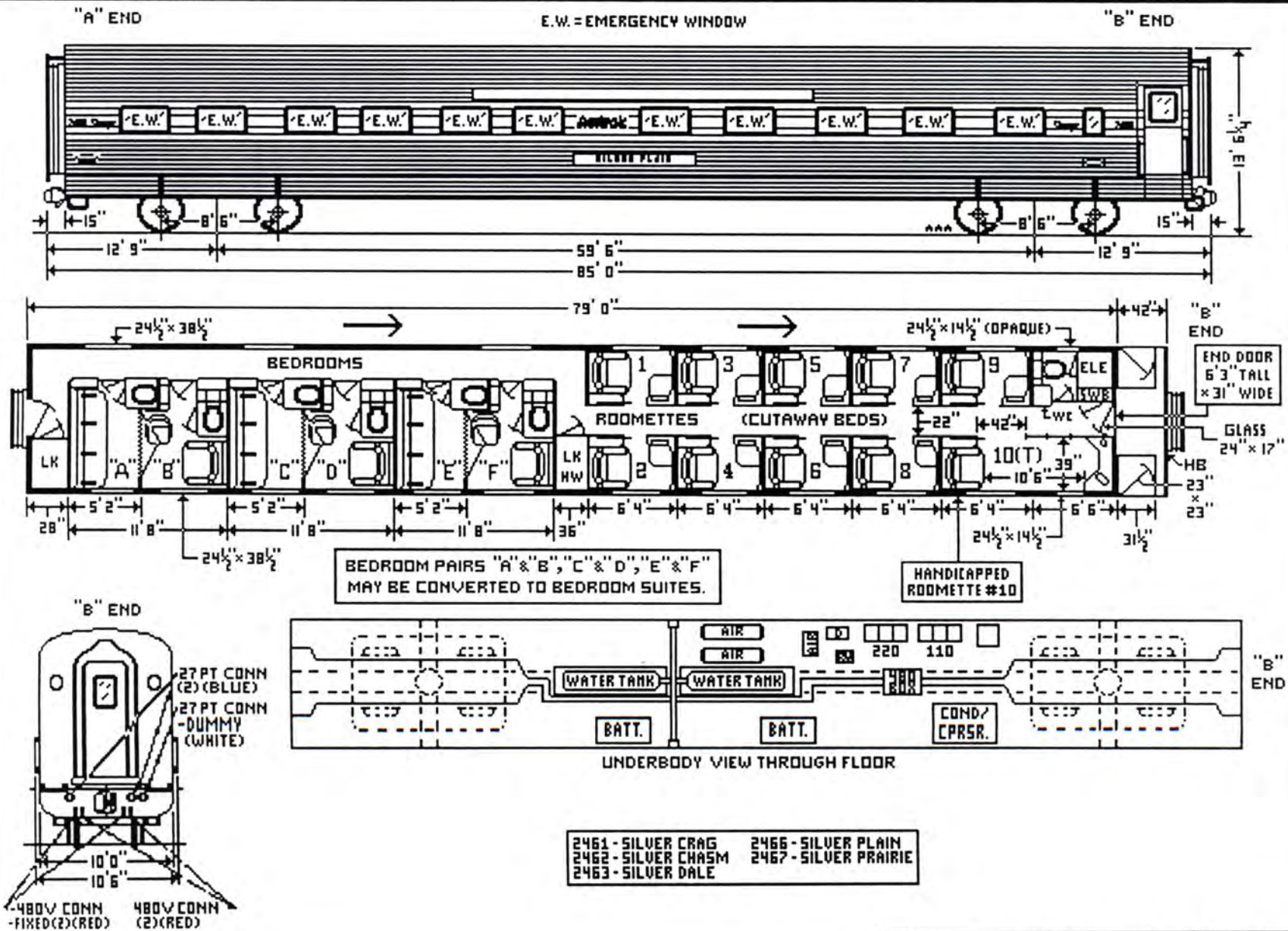

- | | |
|---------------------|-----------------------|
| 2461 - SILVER CRAG | 2466 - SILVER PLAIN |
| 2462 - SILVER CHASM | 2467 - SILVER PRAIRIE |
| 2463 - SILVER DALE | |

HERITAGE HANDICAPPED 10-6 SLEEPER

Eqpt. Code: SH

110 MPH

Car Numbers: 2475,2476

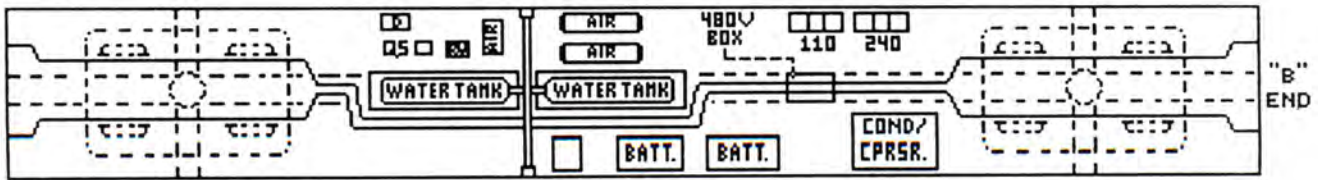
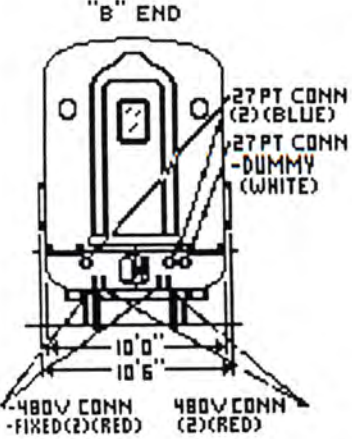
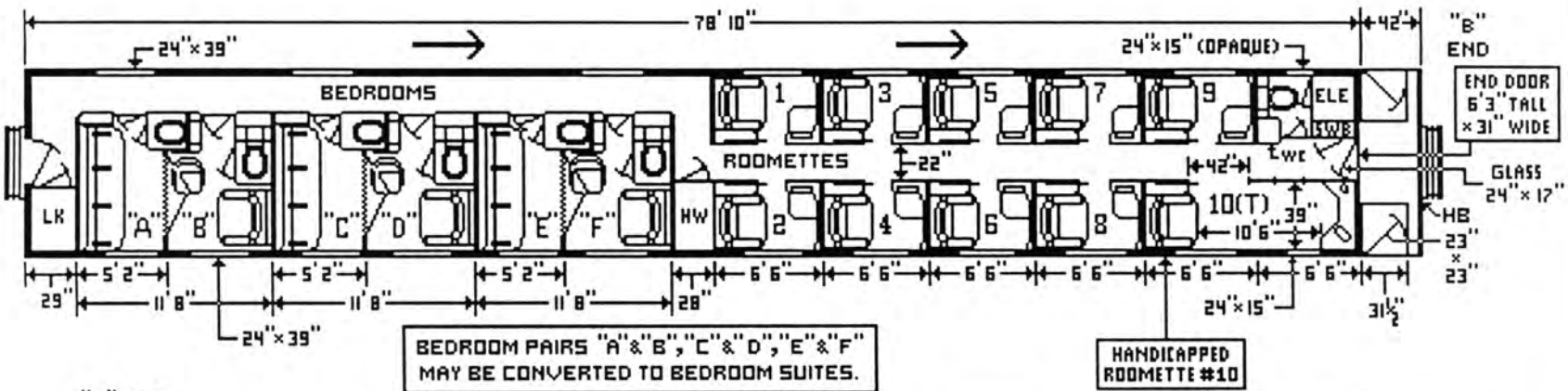
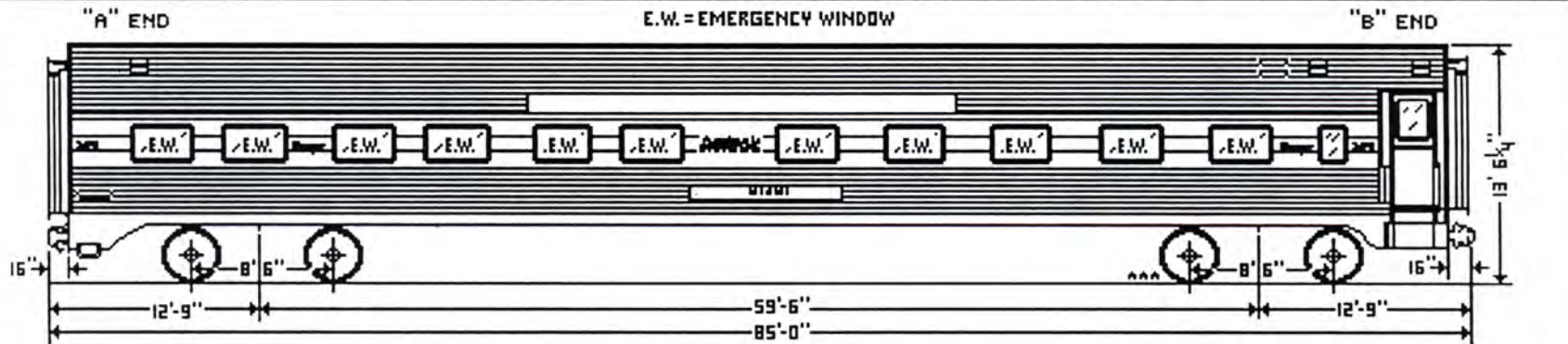

UNDERBODY VIEW THROUGH FLOOR

2475 - MIAMI
2476 - SARASOTA

HERITAGE SMOKING LOUNGE/DORM

Eqpt. Code: SL

110 MPH

Car Numbers: 2500-2597

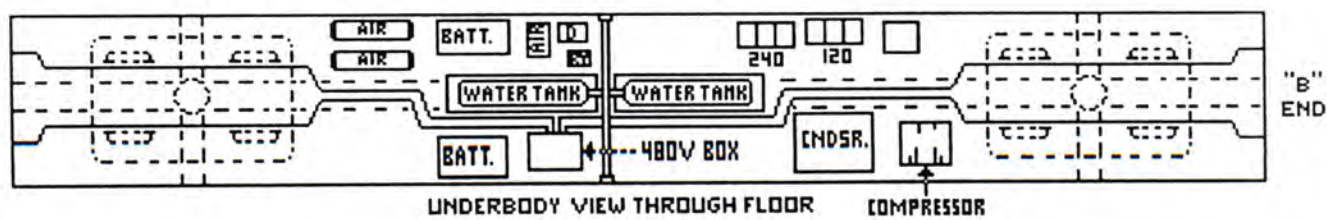
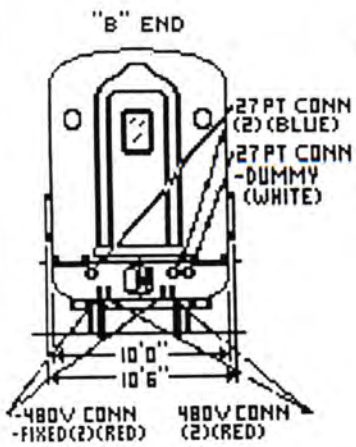
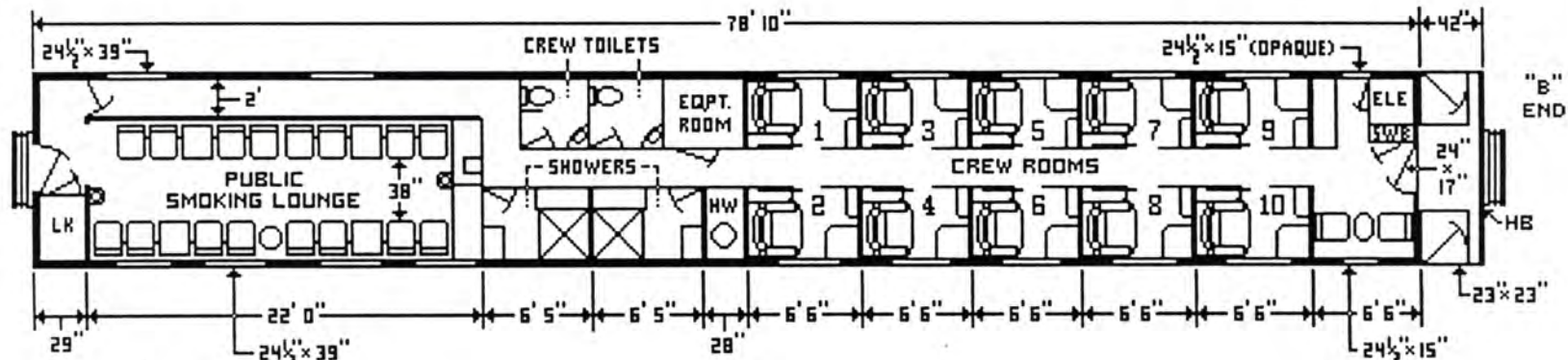
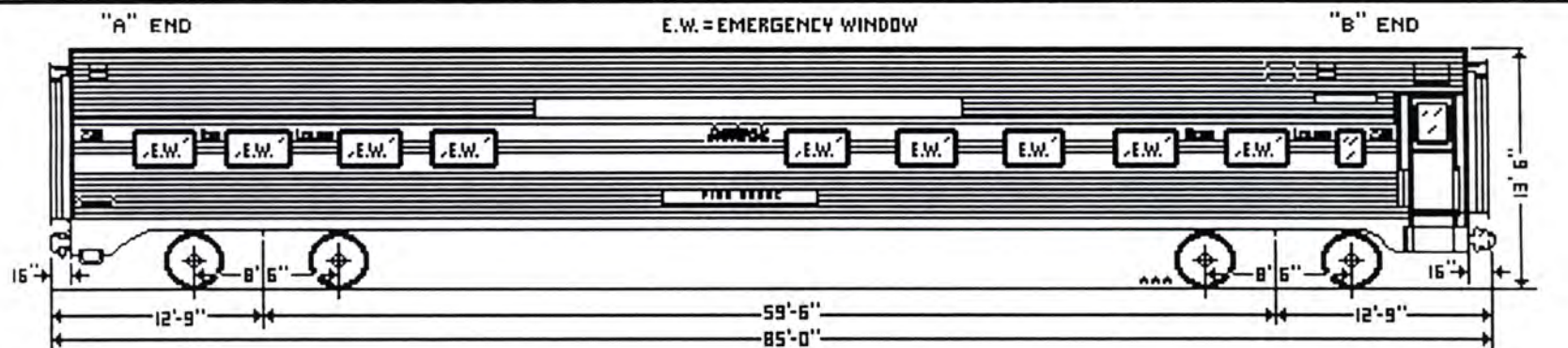

2500-PINE BROOK

HERITAGE 10-6 SLEEPER

Eqpt. Code: SA

110 MPH

Car Numbers: 2880-2941

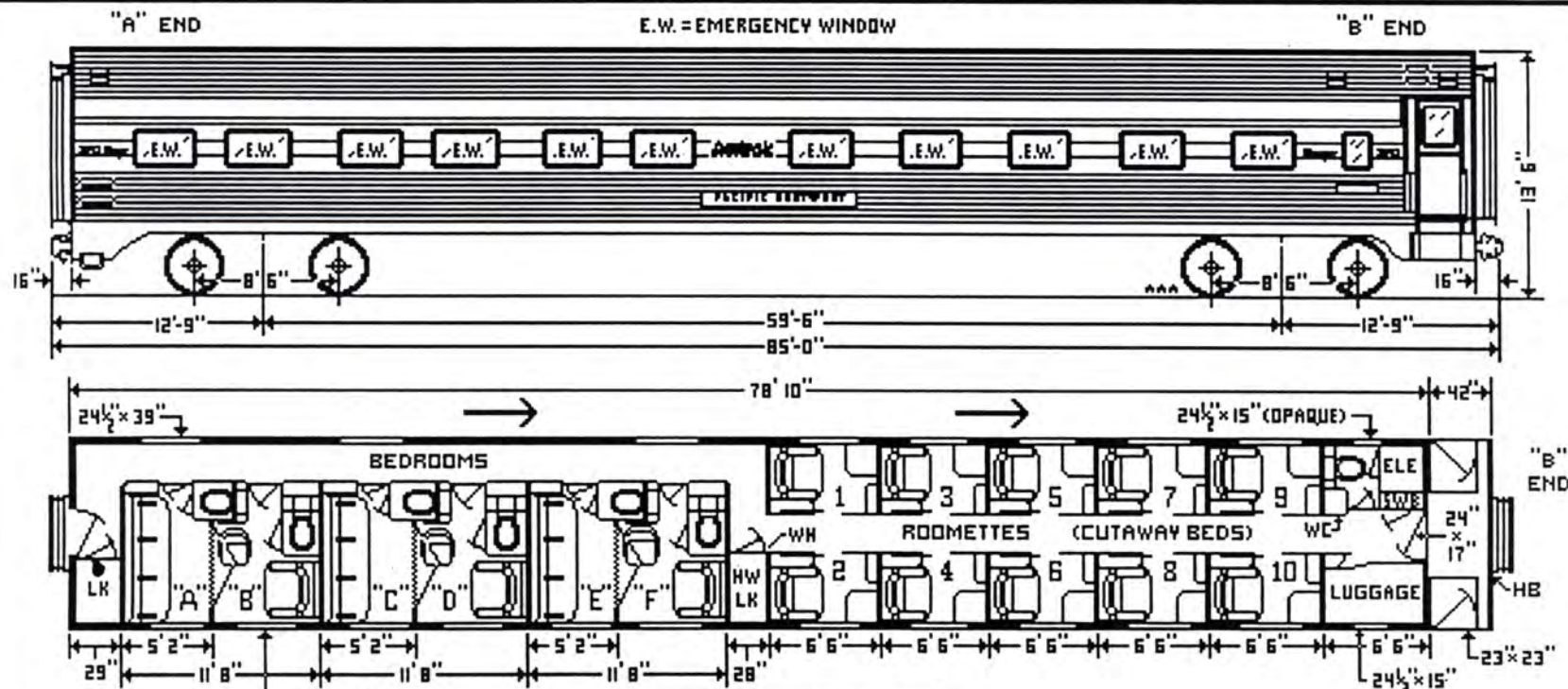

BEDROOM PAIRS "A" & "B", "C" & "D", "E" & "F" MAY BE CONVERTED TO BEDROOM SUITES.

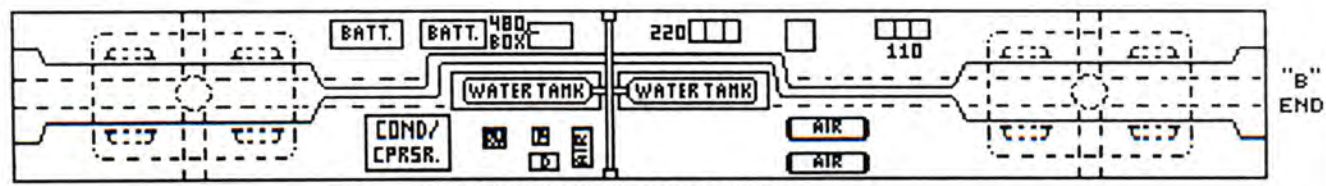
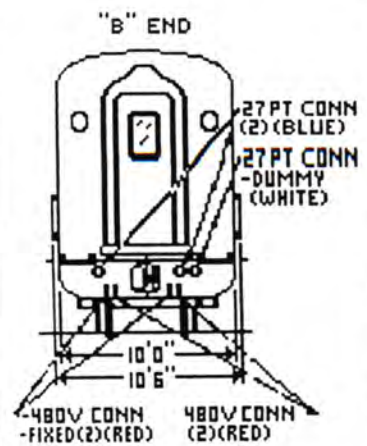

UNDERBODY VIEW THROUGH FLOOR

| | | | | |
|-----------------------|------------------------|--------------------------|-----------------------|-----------------------|
| 2880 - PACIFIC BEAUTY | 2886 - PACIFIC SCENE | 2892 - PACIFIC COMMAND | 2917 - PACIFIC ISLAND | 2940 - PACIFIC VIEW |
| 2881 - PACIFIC SANDS | 2887 - PACIFIC PEAK | 2893 - PACIFIC NORTHWEST | 2920 - PACIFIC MIST | 2941 - PACIFIC WATERS |
| 2882 - PACIFIC TRAIL | 2888 - PACIFIC SPRAY | 2900 - PACIFIC BAY | 2923 - PACIFIC PARK | |
| 2883 - PACIFIC RANGE | 2889 - PACIFIC TERRACE | 2903 - PACIFIC BEND | 2924 - PACIFIC PATROL | |
| 2884 - PACIFIC SLOPE | 2890 - PACIFIC UNION | 2911 - PACIFIC FOREST | 2932 - PACIFIC SHORE | |
| 2885 - PACIFIC HOME | 2891 - PACIFIC CAPE | 2913 - PACIFIC GARDENS | 2933 - PACIFIC SKIES | |

HERITAGE 10-6 SLEEPER

Eqpt. Code: SA

110 MPH

Car Numbers: 2980-2997

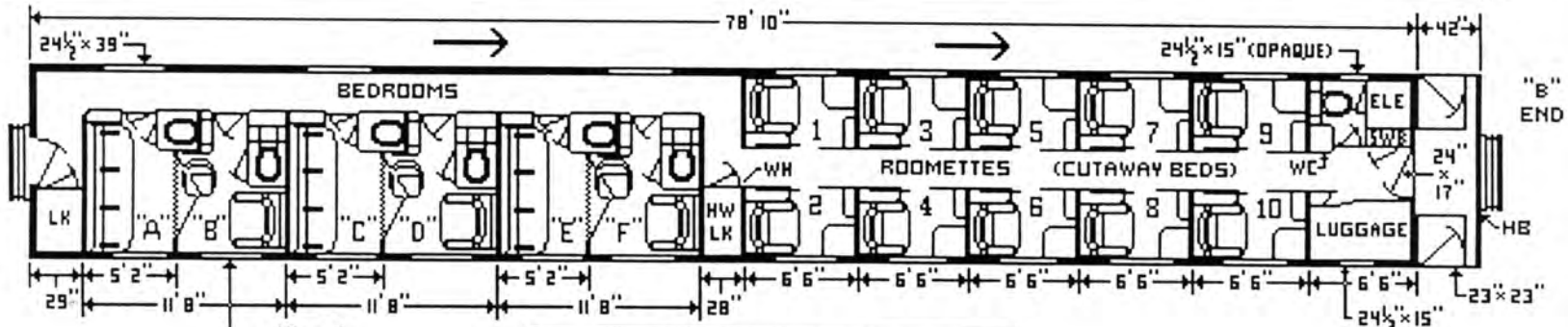
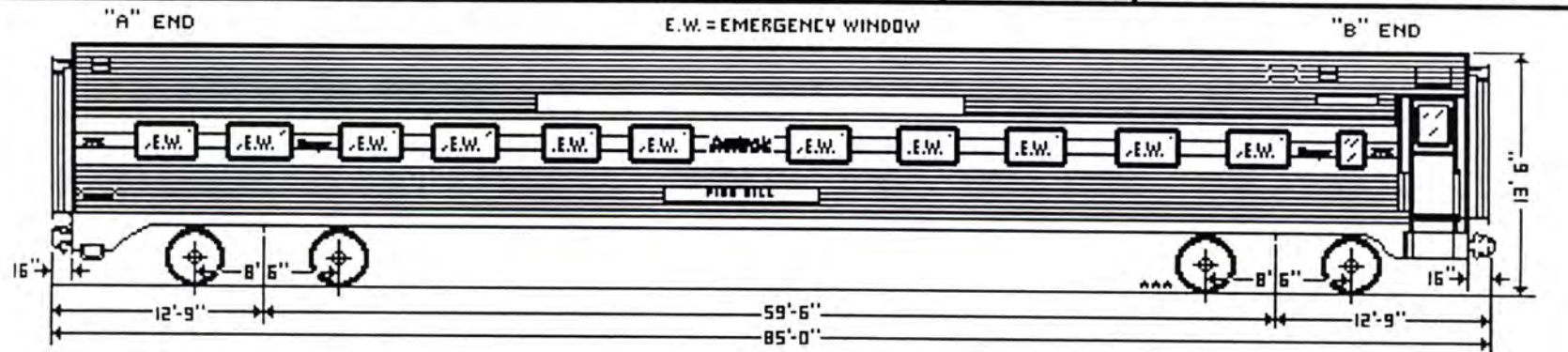

BEDROOM PAIRS "A" & "B", "C" & "D", "E" & "F" MAY BE CONVERTED TO BEDROOM SUITES.

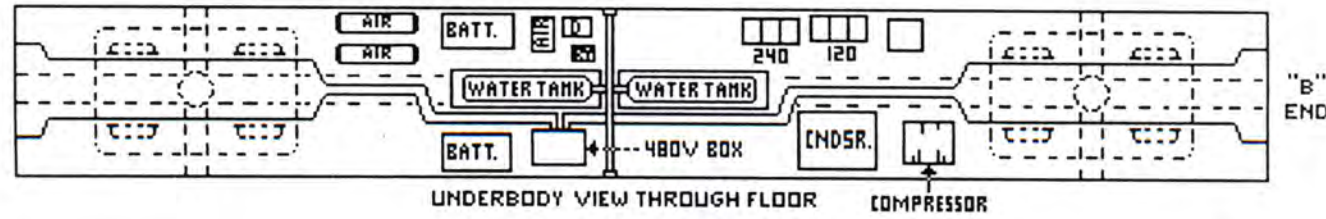
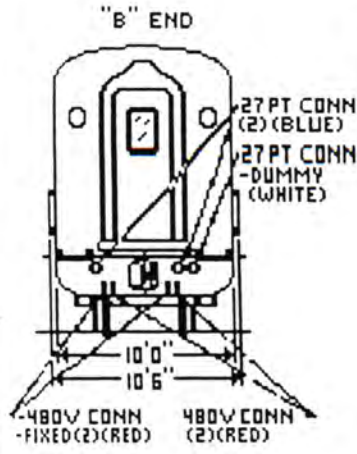

| | | |
|--------------------|-------------------|-------------------|
| 2980 - PINE CREEK | 2988 - PINE DALE | 2994 - PINE LODGE |
| 2983 - PINE ARROYO | 2989 - PINE FERN | 2995 - PINE BROOK |
| 2984 - PINE CAVERN | 2990 - PINE GROVE | 2996 - PINE HILL |
| 2985 - PINE KING | 2991 - PINE BEACH | 2997 - PINE RING |
| 2986 - PINE MESA | 2992 - PINE PEAK | |
| 2987 - PINE SHOLE | 2993 - PINE GORGE | |

HERITAGE LOUNGE CAR

Equipment Code: LA

110 MPH

Car Nos: 3100-3105

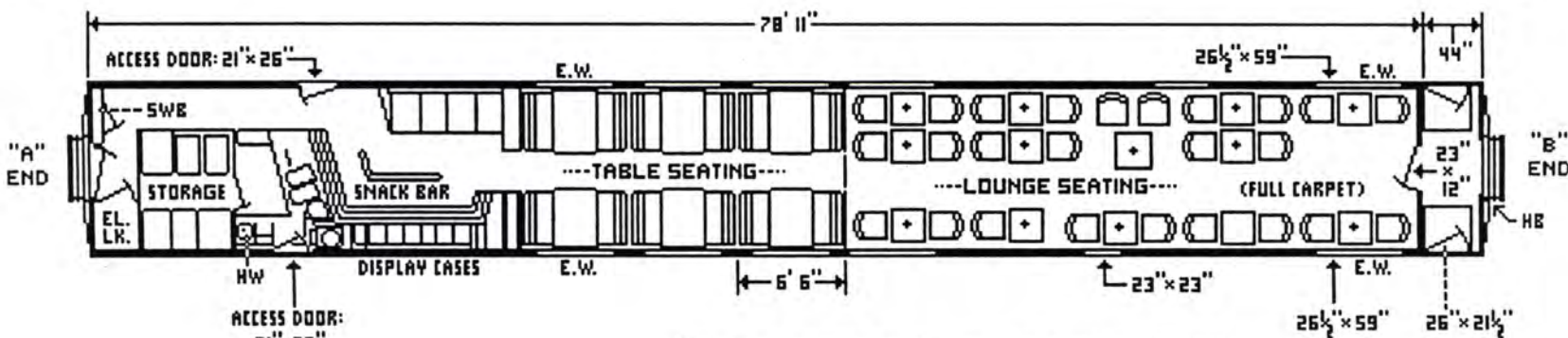
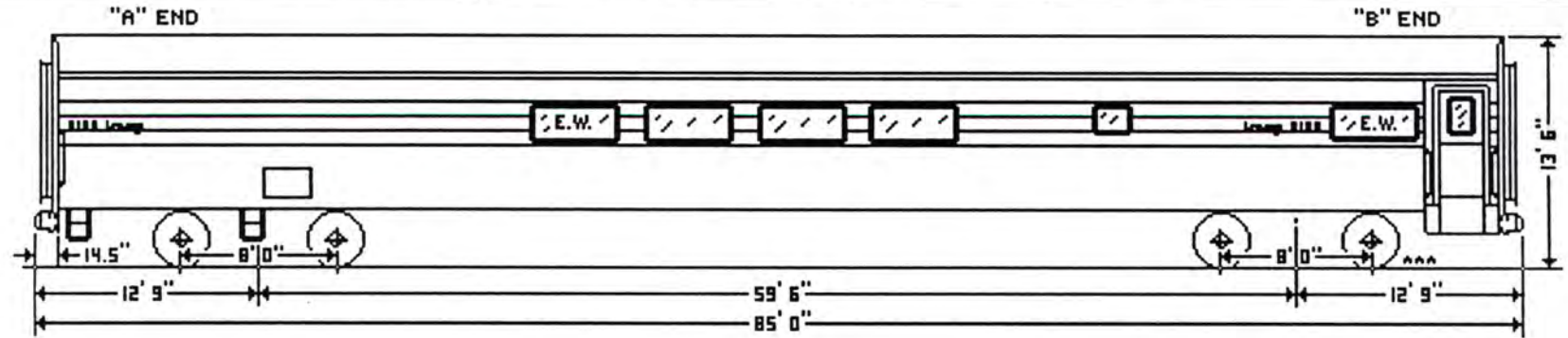

3102/3104 TO NCDOT 1996 E.W. = EMERGENCY WINDOW

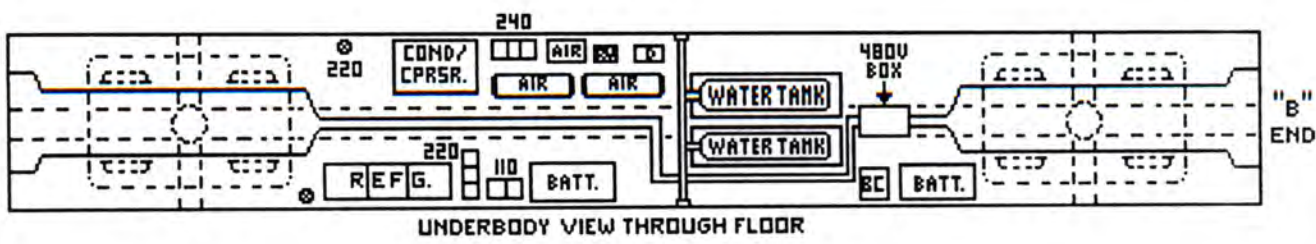
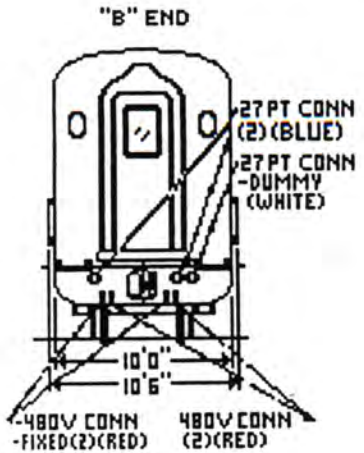

LOUNGE SEATS: 25
TABLE SEATS: 24

HERITAGE LOUNGE CAR

Equipment Code: LA

110 MPH

Car Nos: 3106-3112

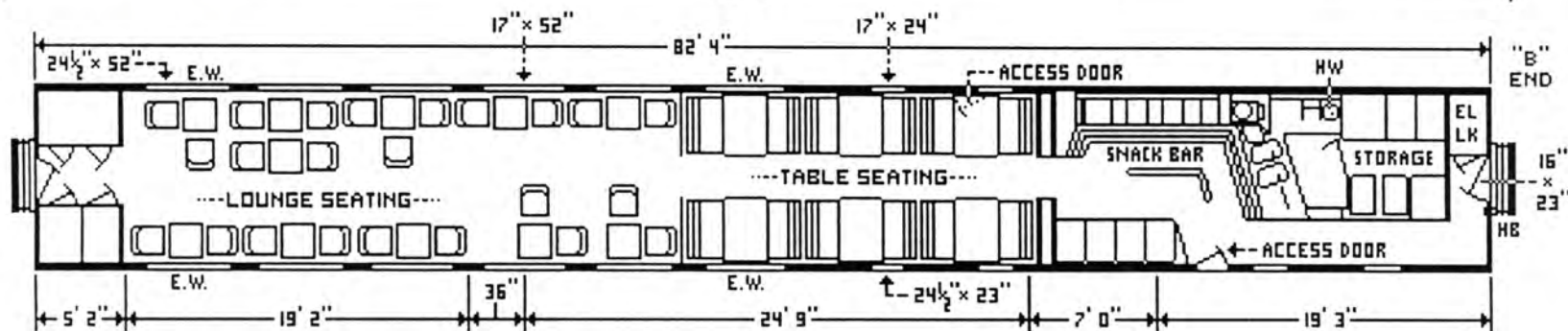
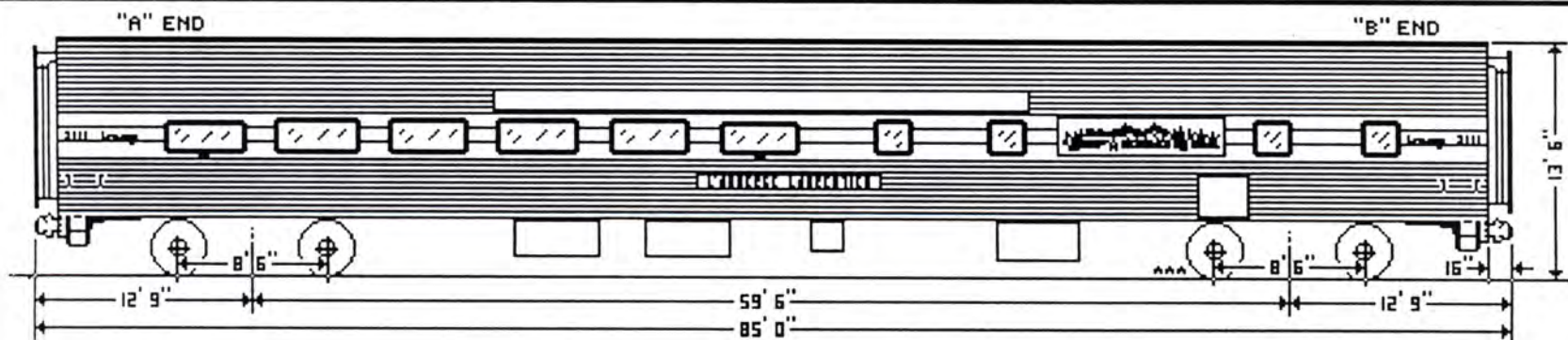

3111 - L'AUBERGE LAURENTIEN

E.W. = EMERGENCY WINDOW

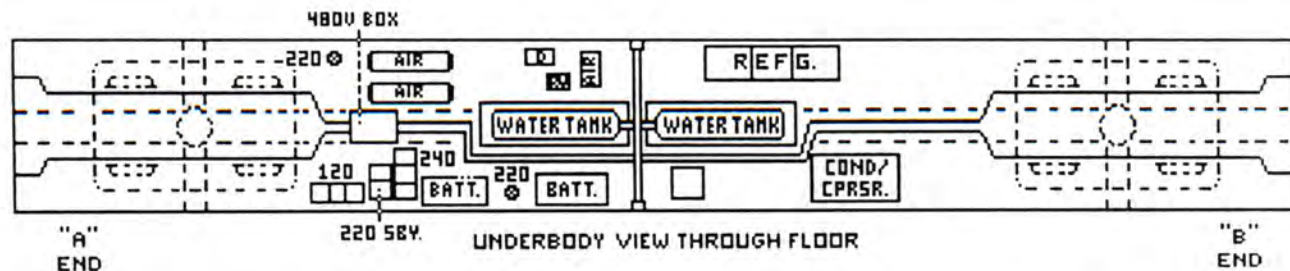
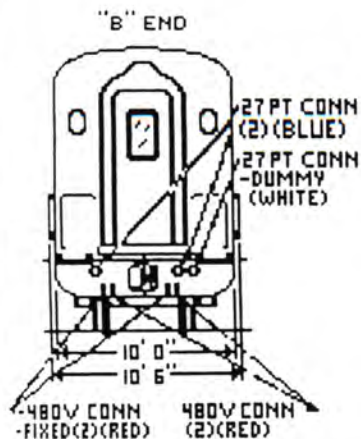

LOUNGE SEATS: 23
TABLE SEATS: 24

HERITAGE LOUNGE CAR

Equipment Code: LA

110 MPH

Car Nos: 3113, 3114

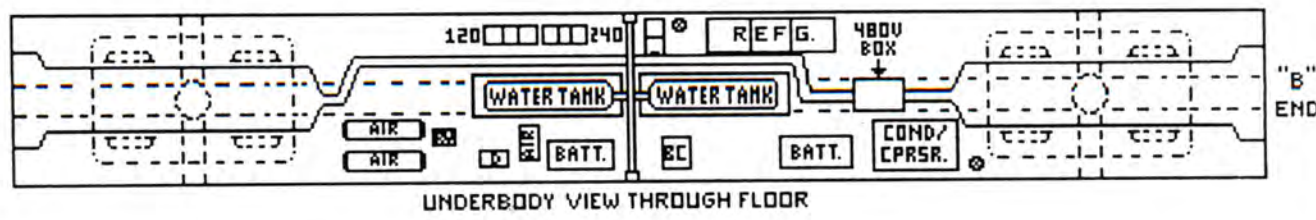
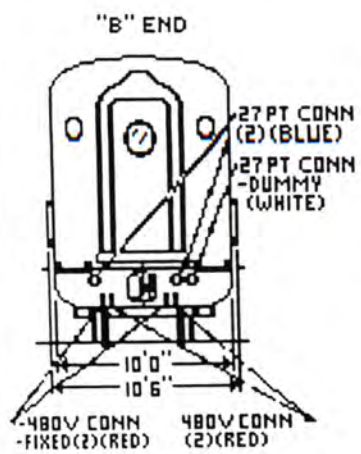
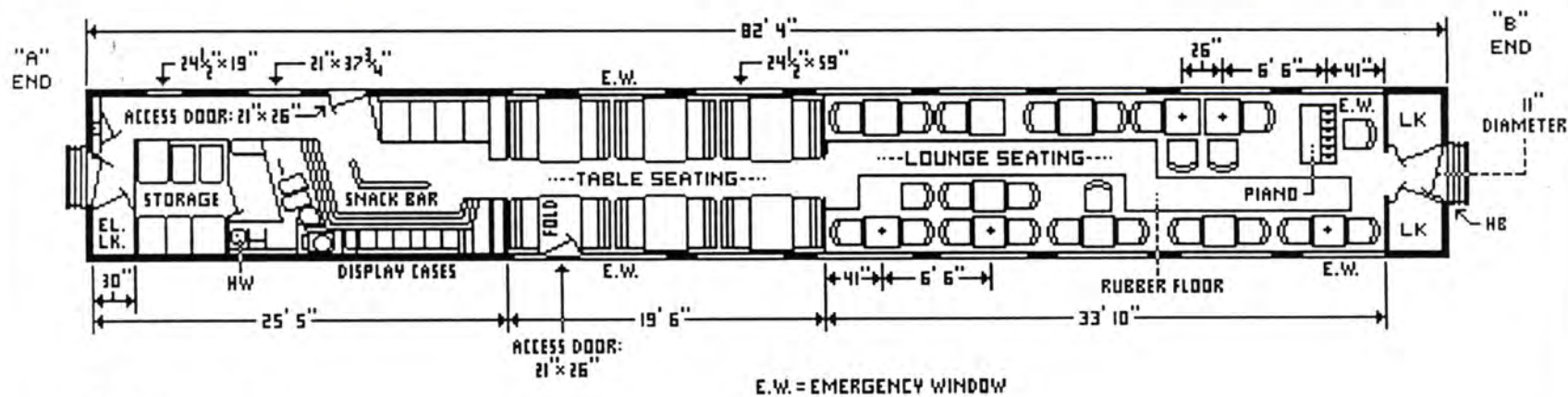
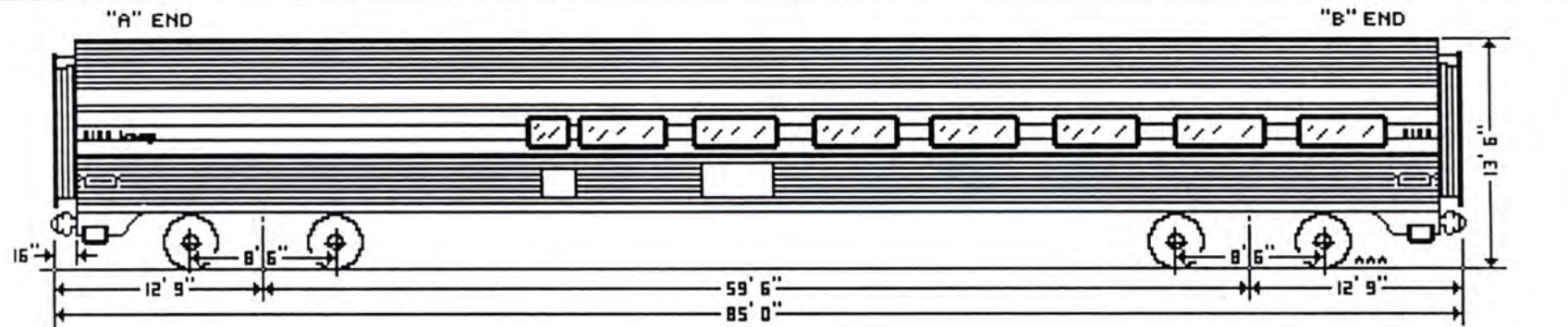

LOUNGE SEATS: 23
TABLE SEATS: 24

HERITAGE HANDICAPPED COACH

Equipment Code: CH

110 MPH

Car Nos: 4000-4020

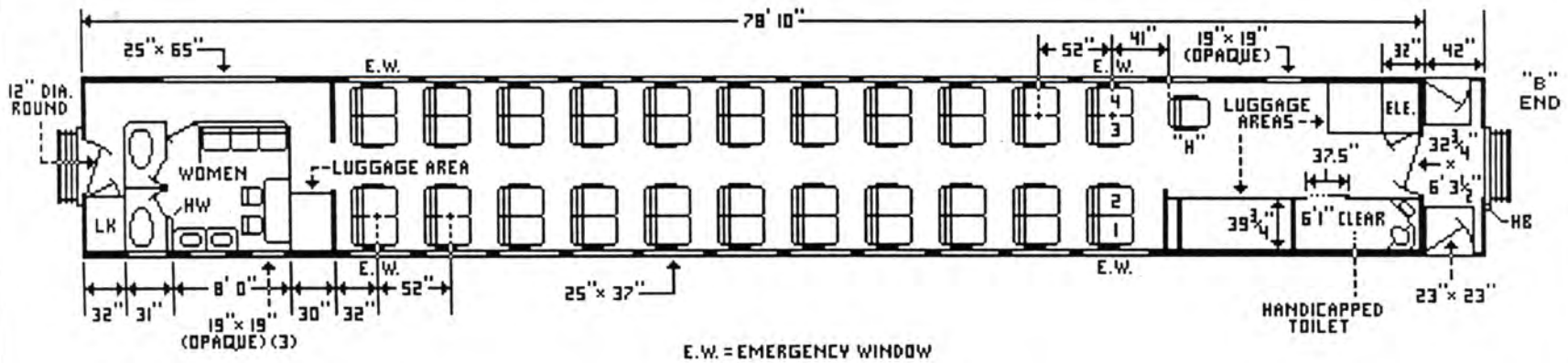
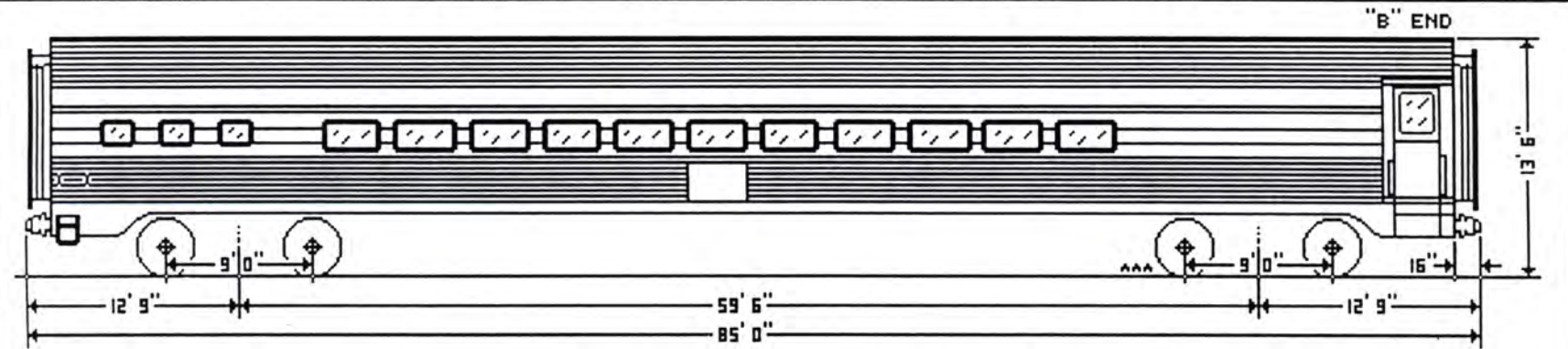

E.W. = EMERGENCY WINDOW

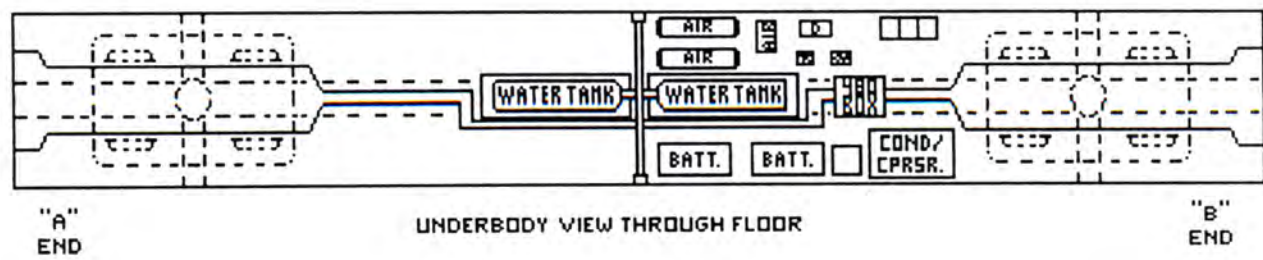
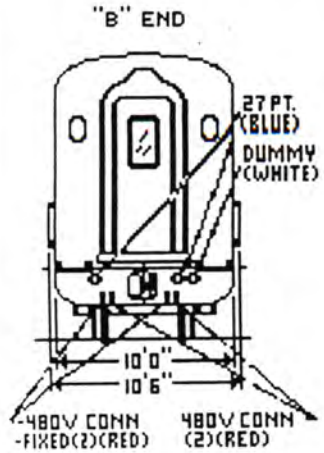

SEATS:45

HERITAGE COACH

Equipment Code: CA

110 MPH

Car Nos: 4600-4626,4646,4647

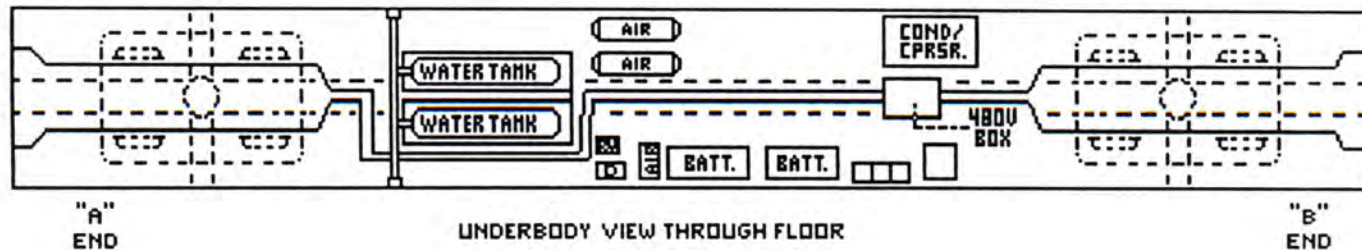
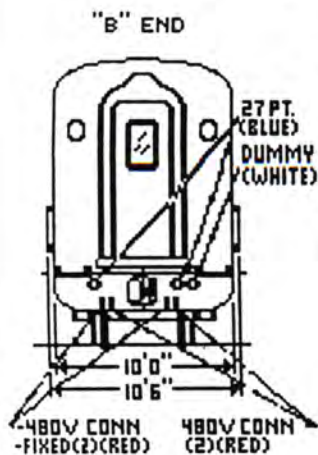
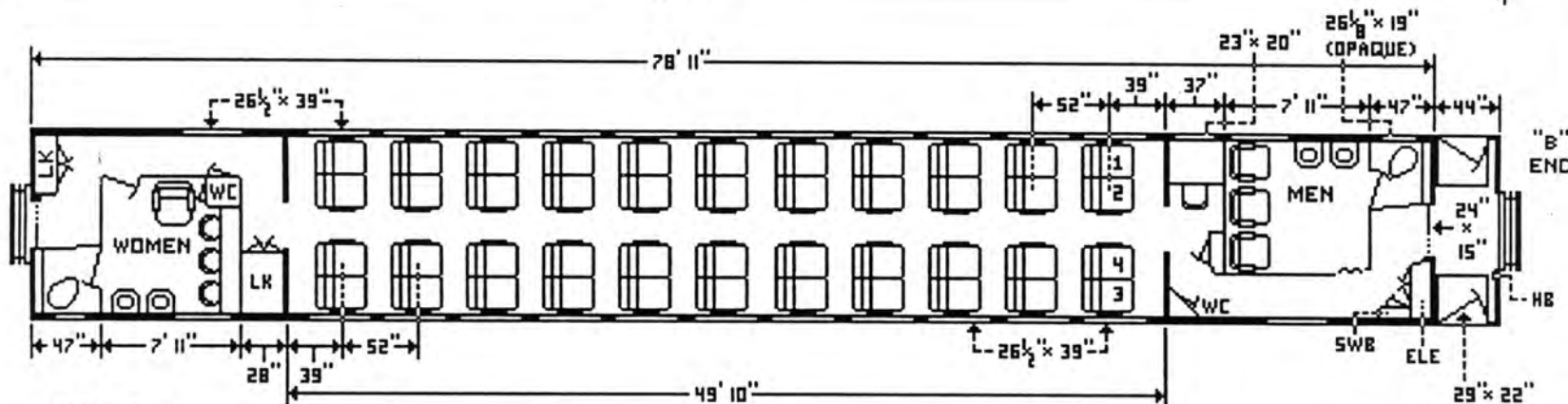
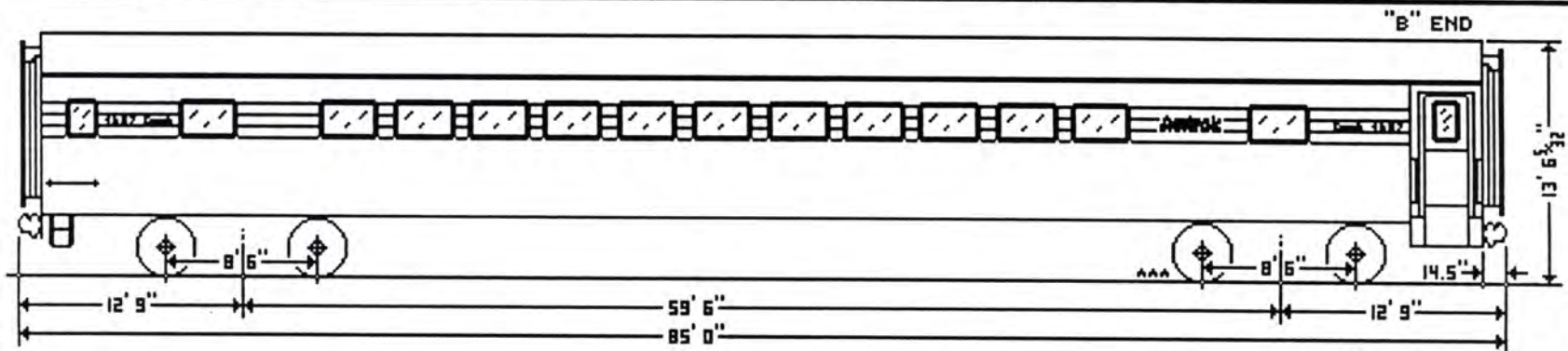

SEATS:44

HERITAGE COACH

Equipment Code: CA

110 MPH

Car Nos: 4627-4644

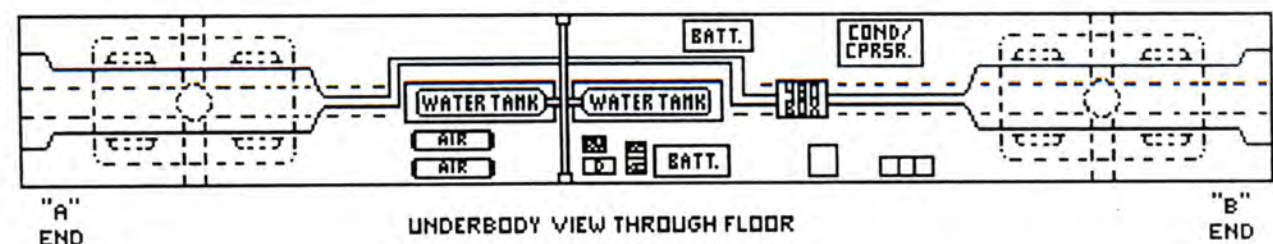
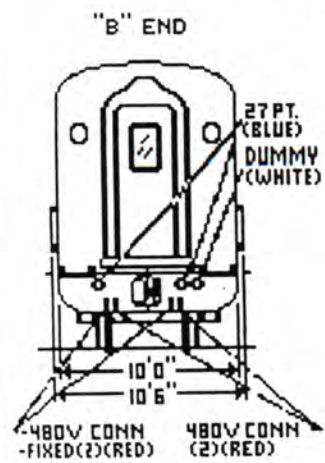
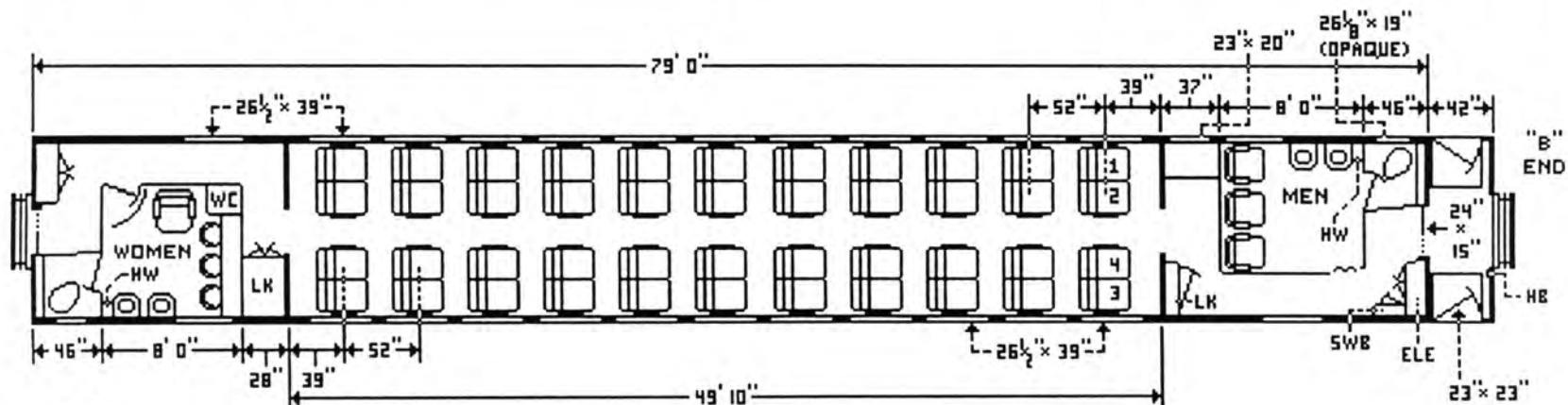
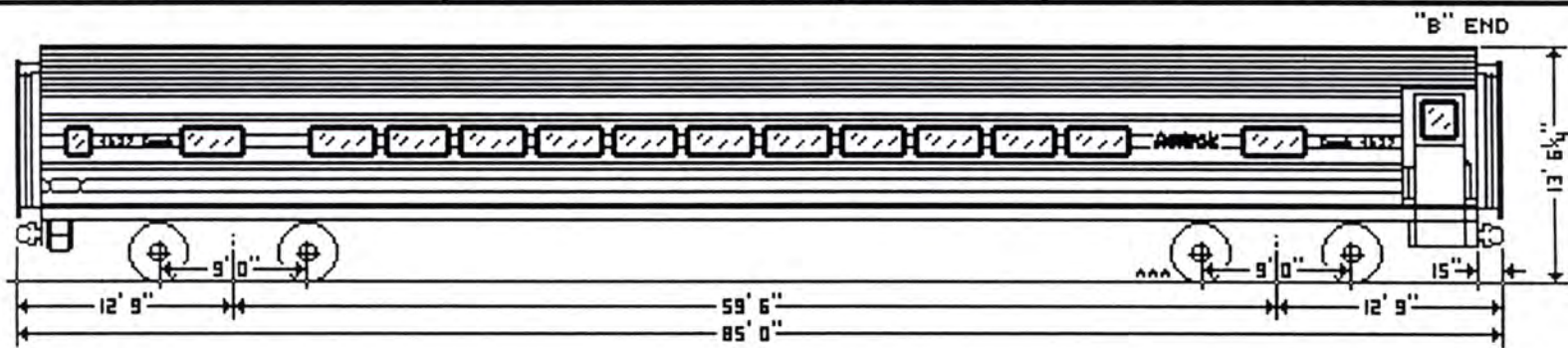

SEATS:44

HERITAGE COACH

Equipment Code: CA

110 MPH

Car Nos: 4700-4739

"B" END

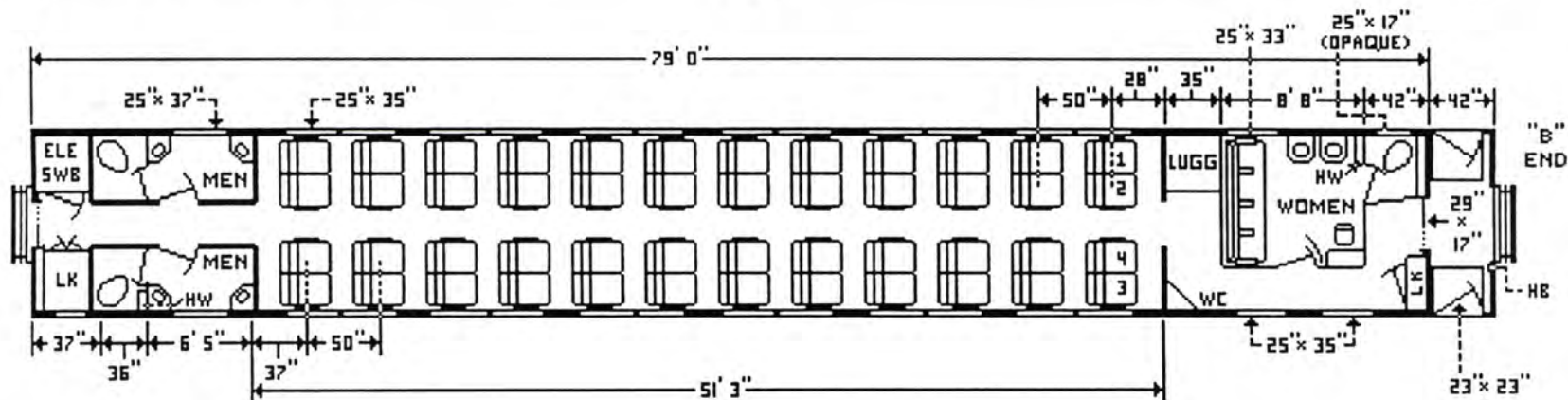
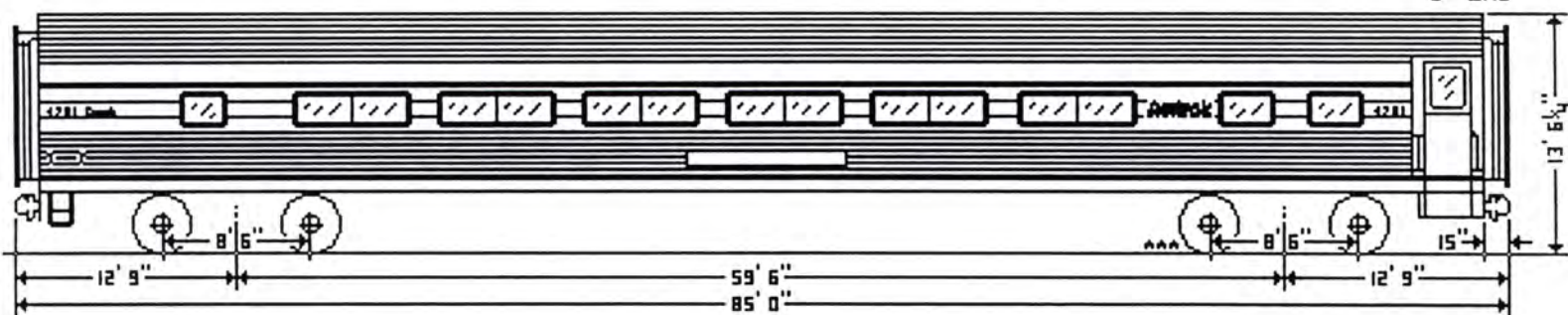

"B" END

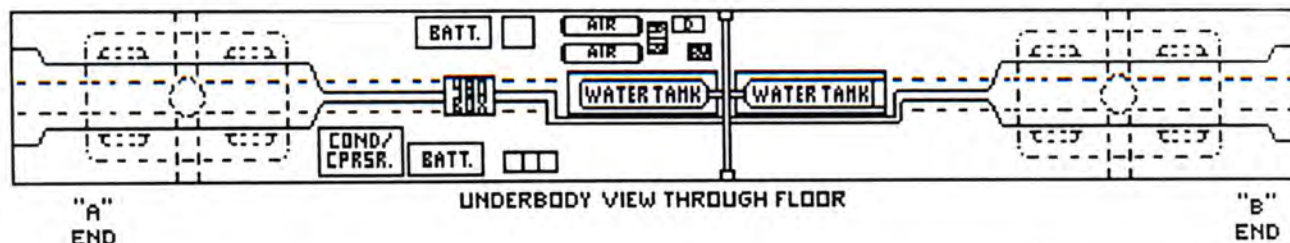
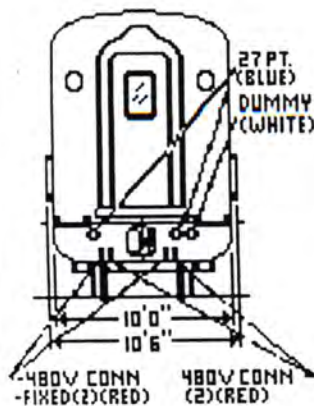

SEATS: 48

"CLOCKER" HANDICAPPED COACH

Equipment Code: KH

110 MPH

Car Nos: 7001-7003, 7006

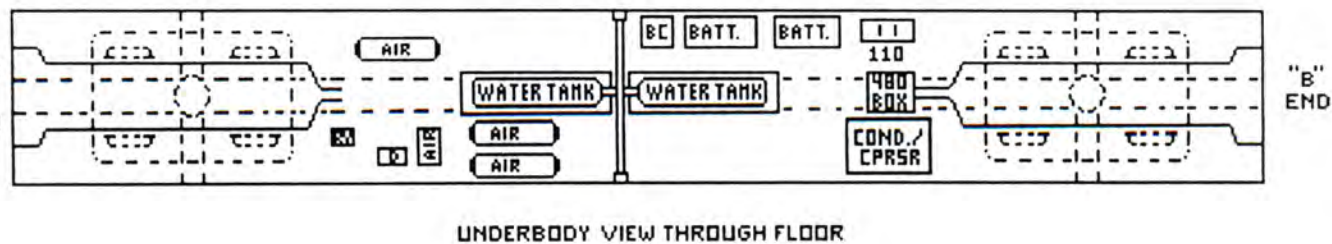
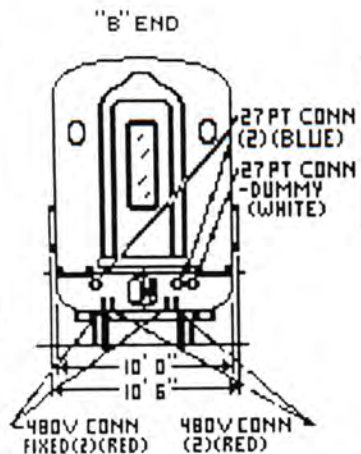
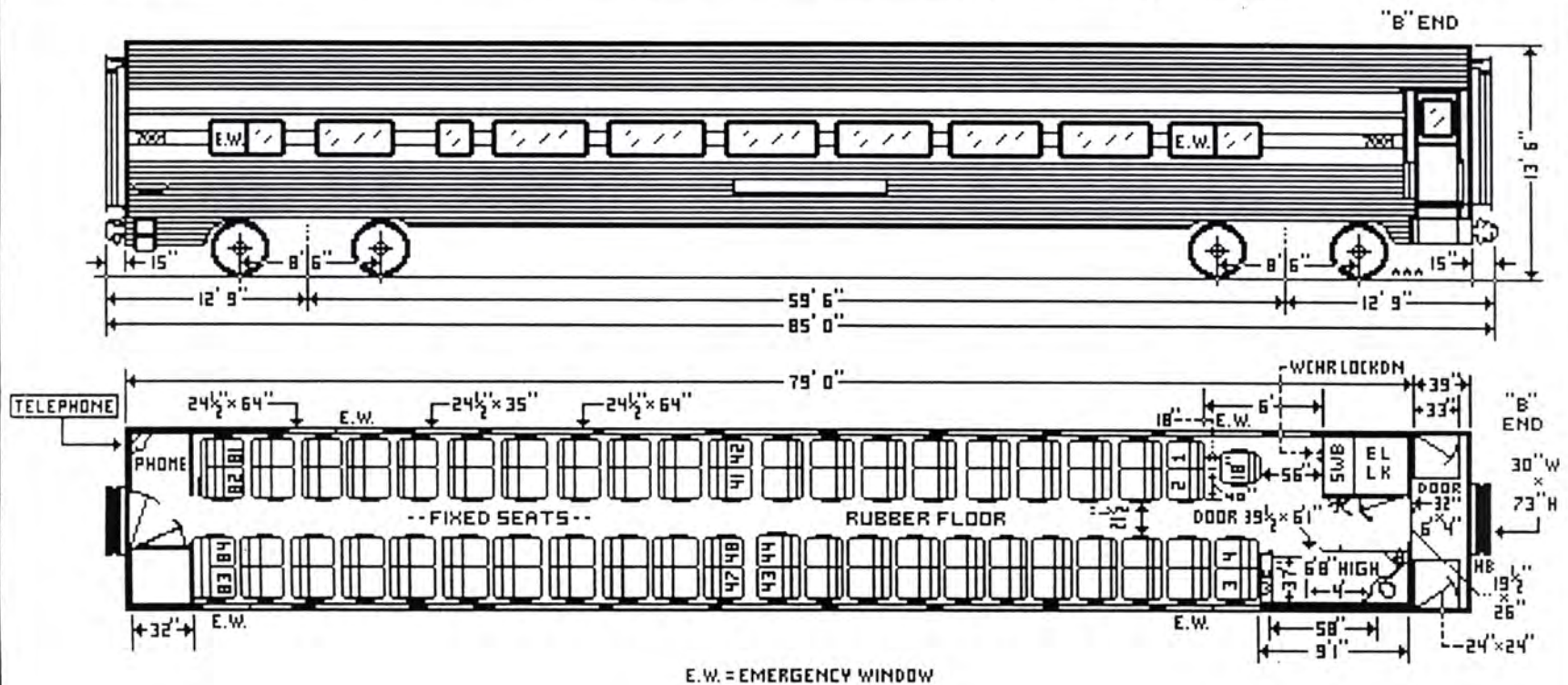

• TELEPHONE EQUIPPED •

SEATS: 85

"CLOCKER" COACH

Equipment Code: KA

110 MPH

Car Nos: 7600-7618

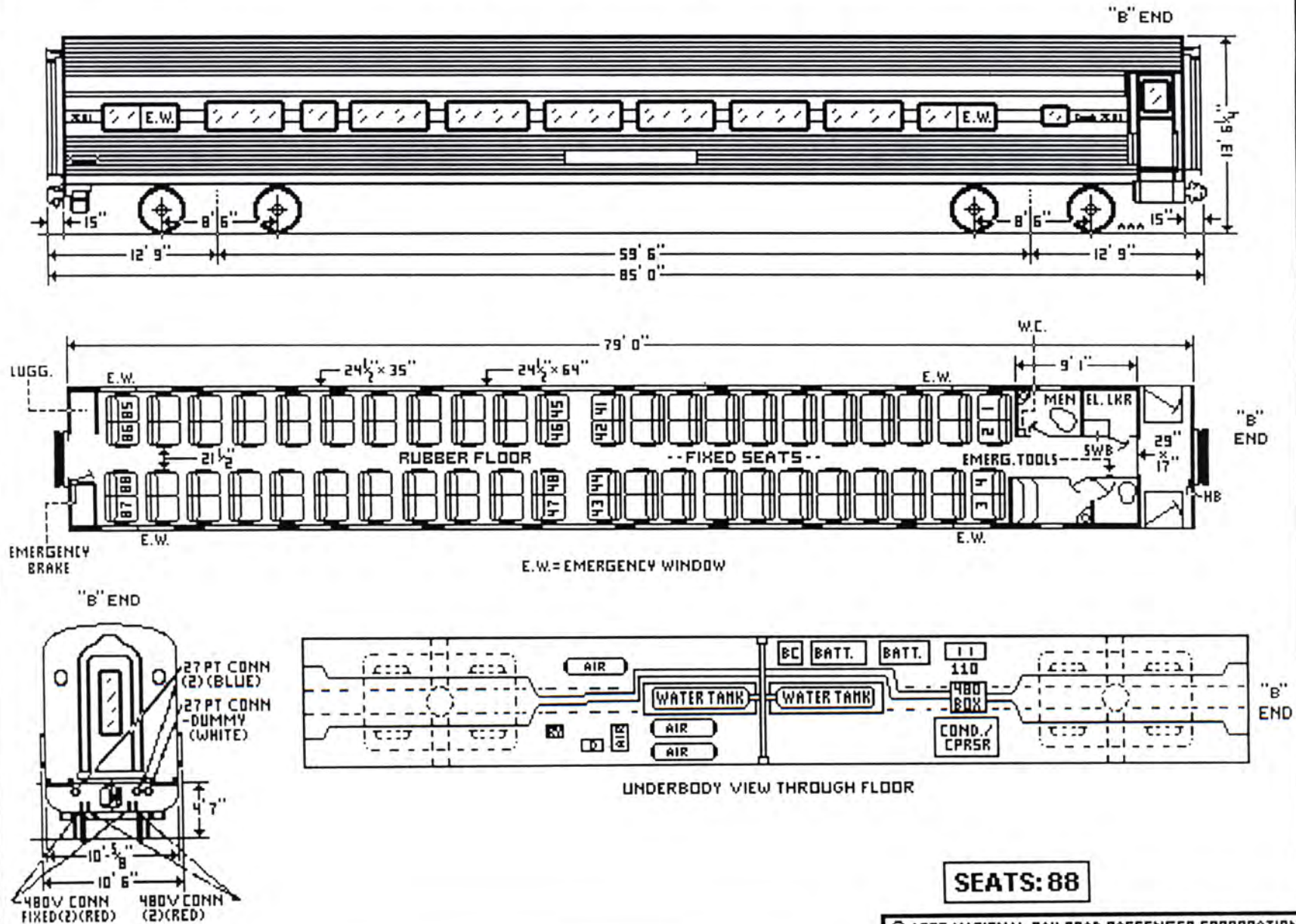

HERITAGE "ADIRONDACK" COACH

Eqpt. Code: KA 110 MPH

Car #: 7602, 7606, 7611, 7615-7617

"ADIRONDACK" LOGO

"B" END

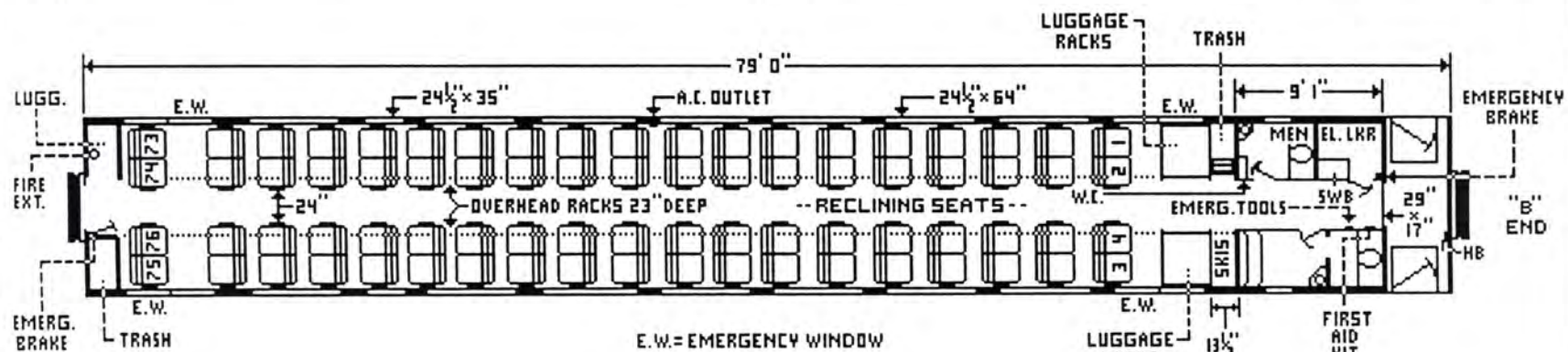
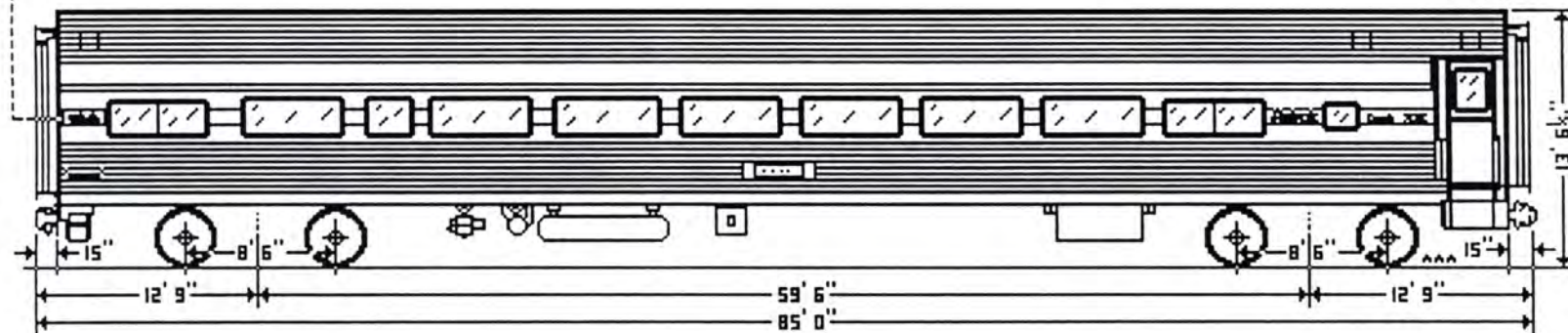

E. W. = EMERGENCY WINDOW

"B" END

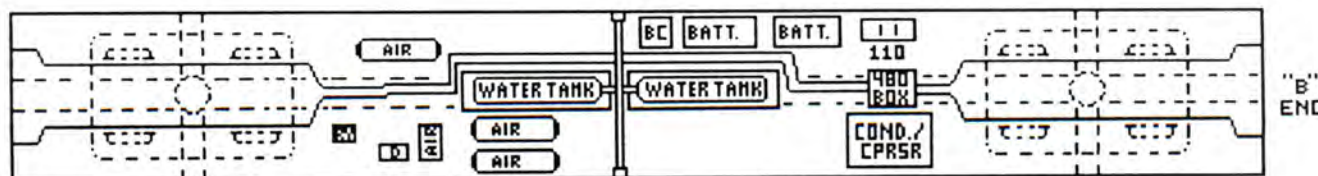
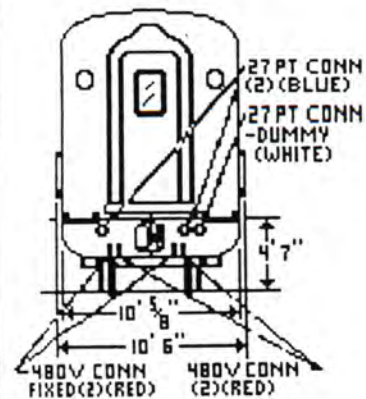

UNDERBODY VIEW THROUGH FLOOR

7602 - ALBANY 7615 - GLENS FALLS
 7606 - SCHENECTADY 7616 - WHITEHALL
 7611 - NEW YORK CITY 7617 - FORT EDWARD

SEATS: 76

"CLOCKER" COACH (RENOVATED)

Eqpt. Code: KA

110 MPH

Car Numbers: 7603, 7608, 7609, 7613

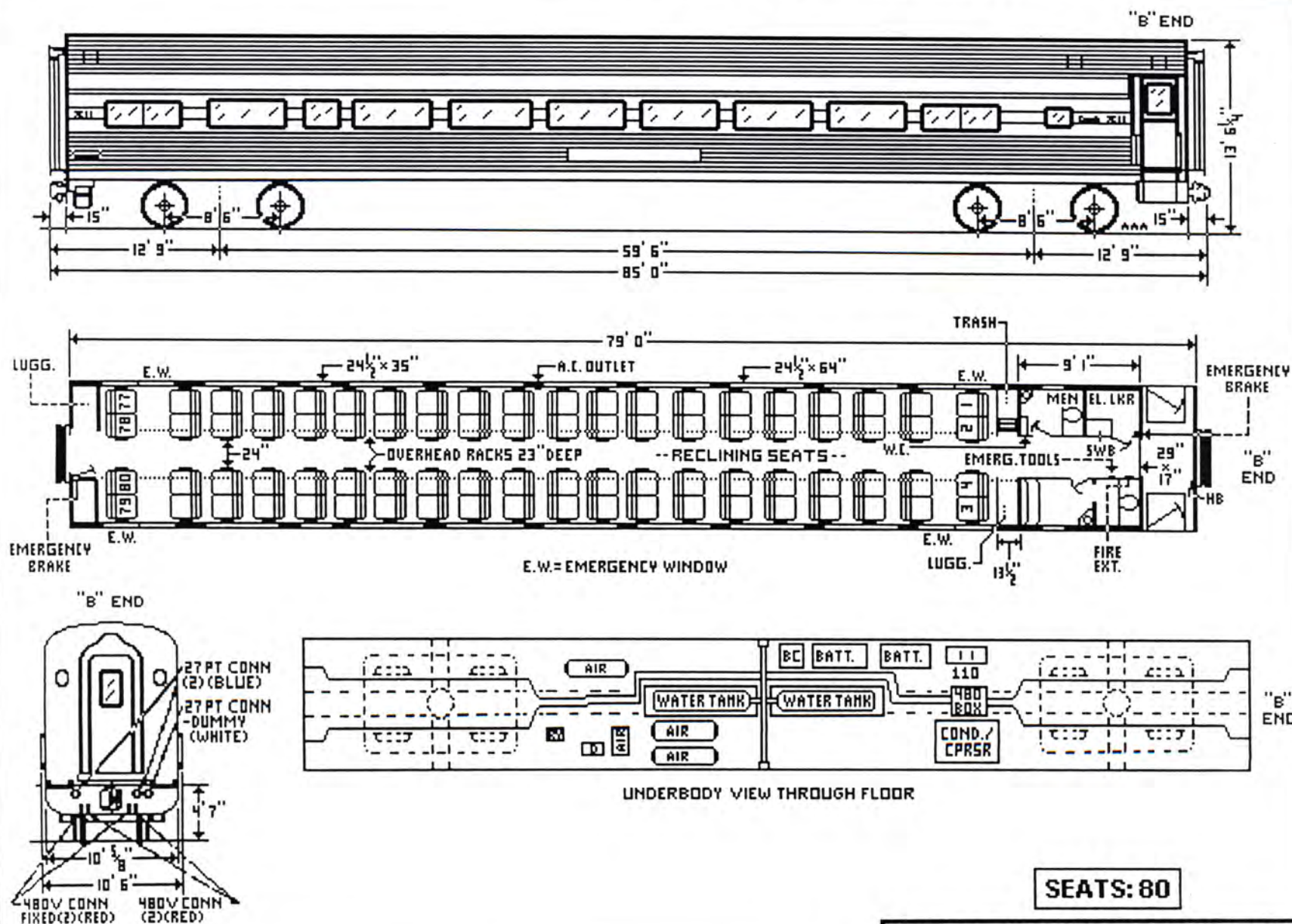

"CLOCKER" COACH

Equipment Code: KA

110 MPH

Car Nos: 7621,7622,7624-7629

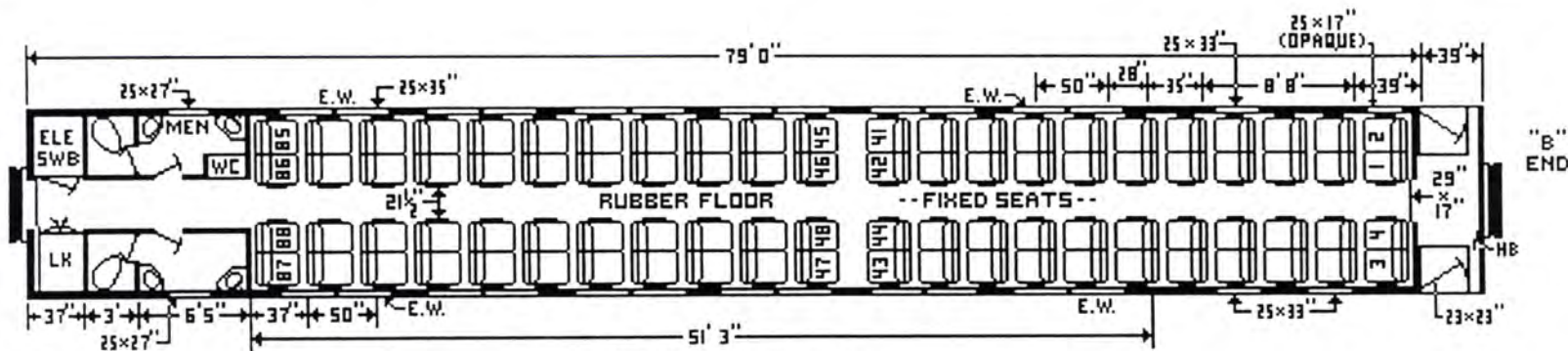
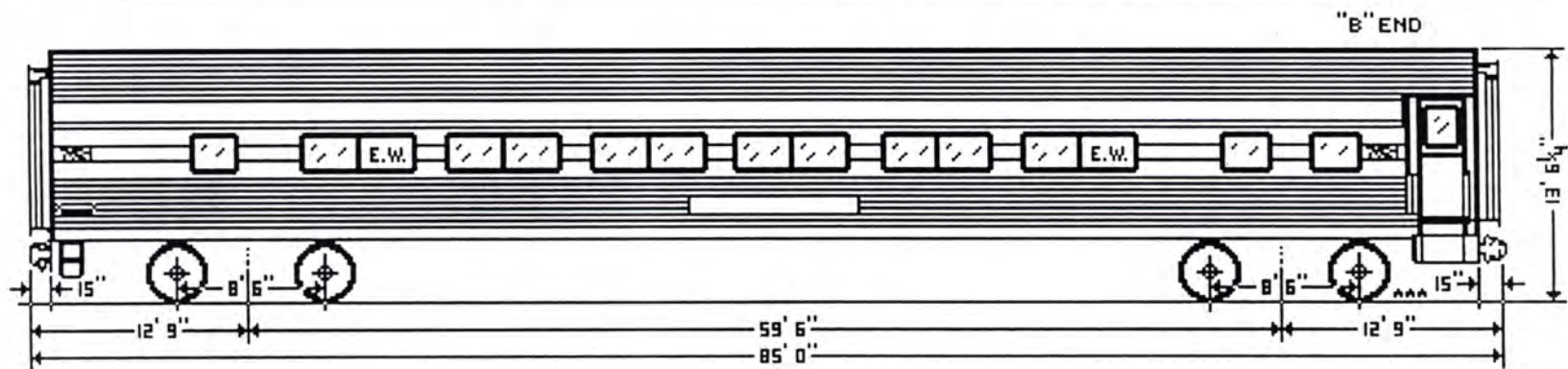

E.W.= EMERGENCY WINDOW

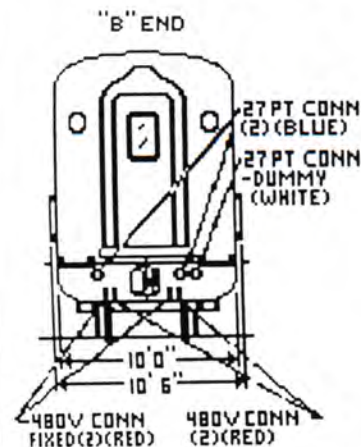

UNDERBODY VIEW THROUGH FLOOR

SEATS: 88

VIEWLINER DINER (PROTOTYPE)

Equipment Code: VF

125 MPH

Car Number: 8400

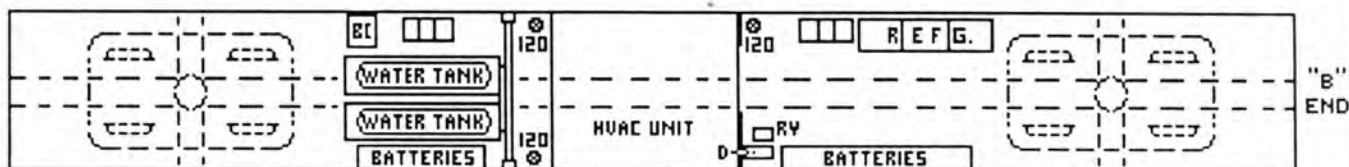
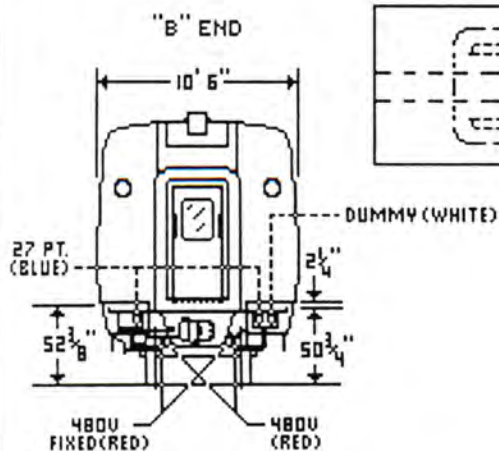
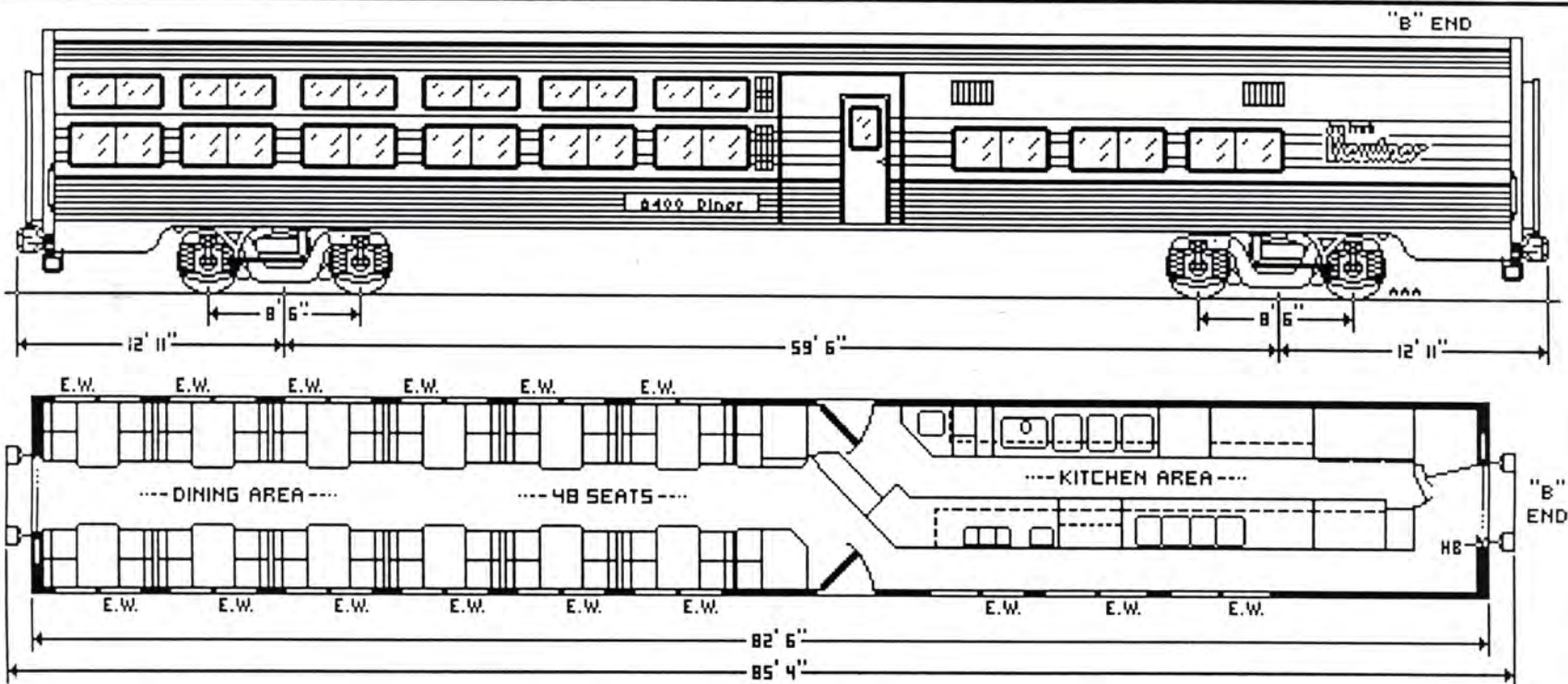

UNDERBODY VIEW THROUGH FLOOR

SEATS:48

HERITAGE DINING CAR

Equipment Code: DA

110 MPH

Car Nos: 8505-8509

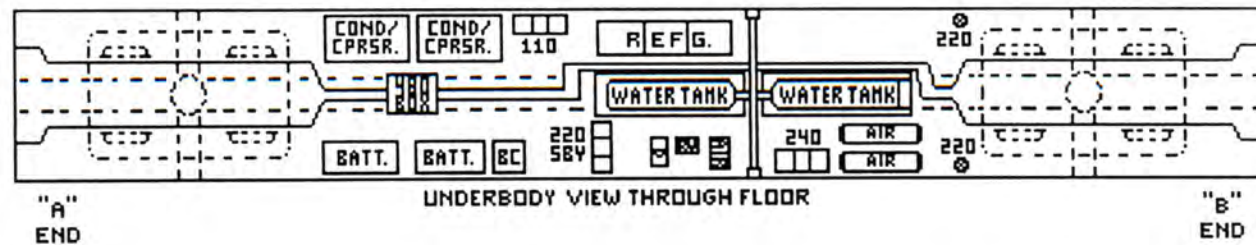
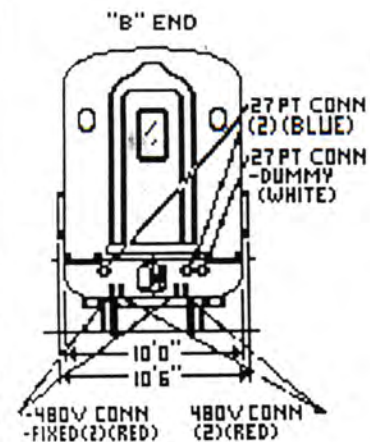
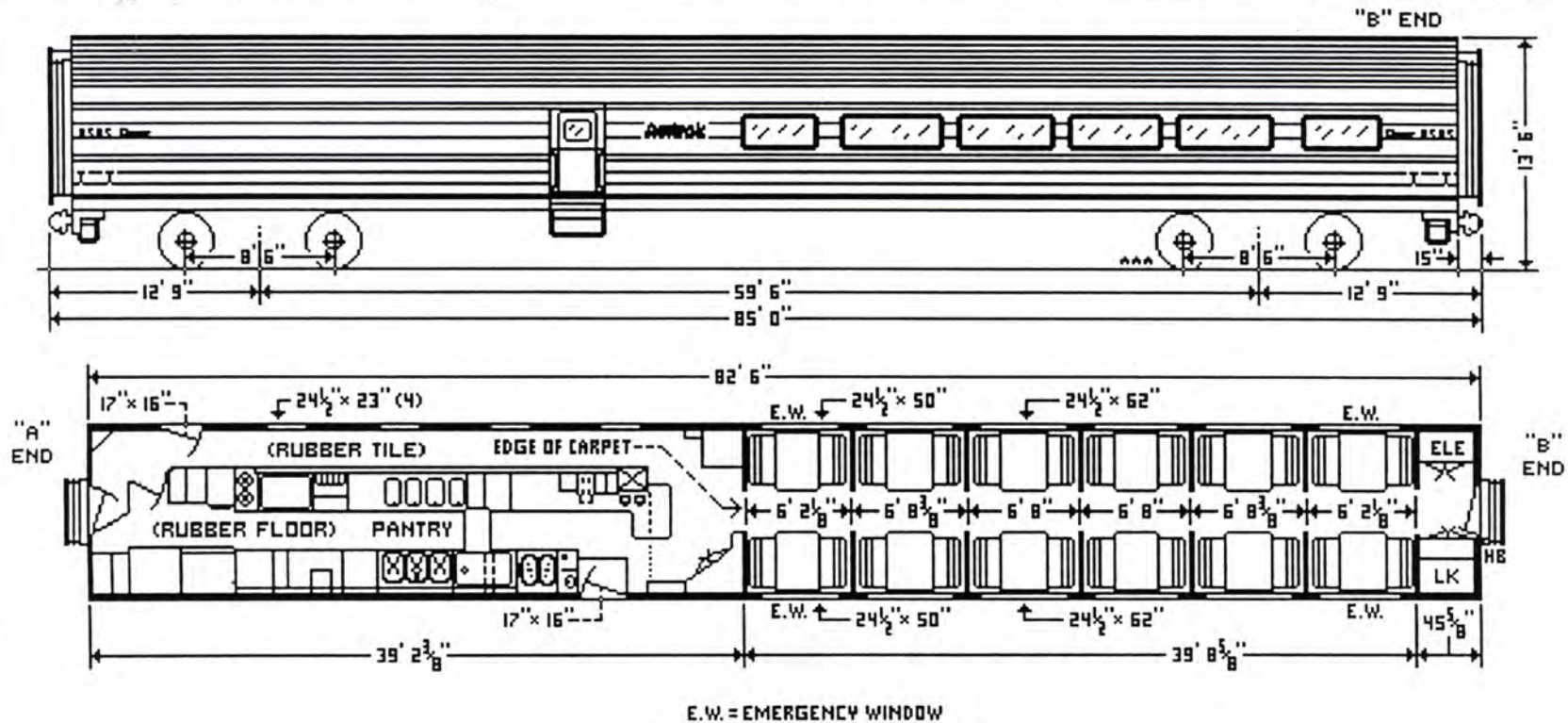

SEATS: 48

HERITAGE DINER GRILL

Equipment Code: DG

110 MPH

Car Number: 8552

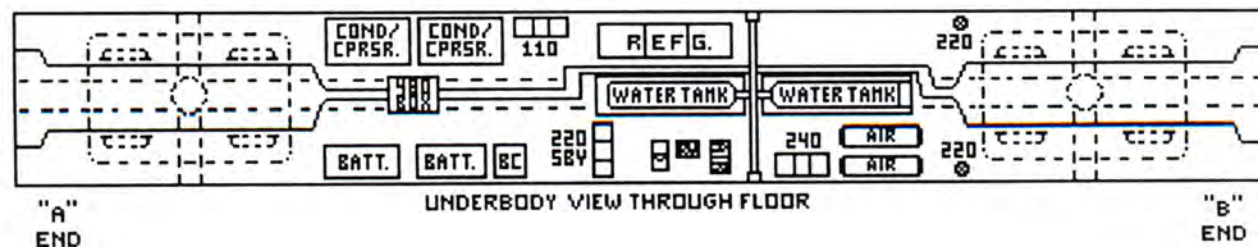
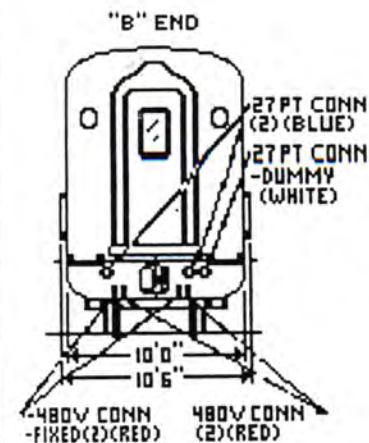
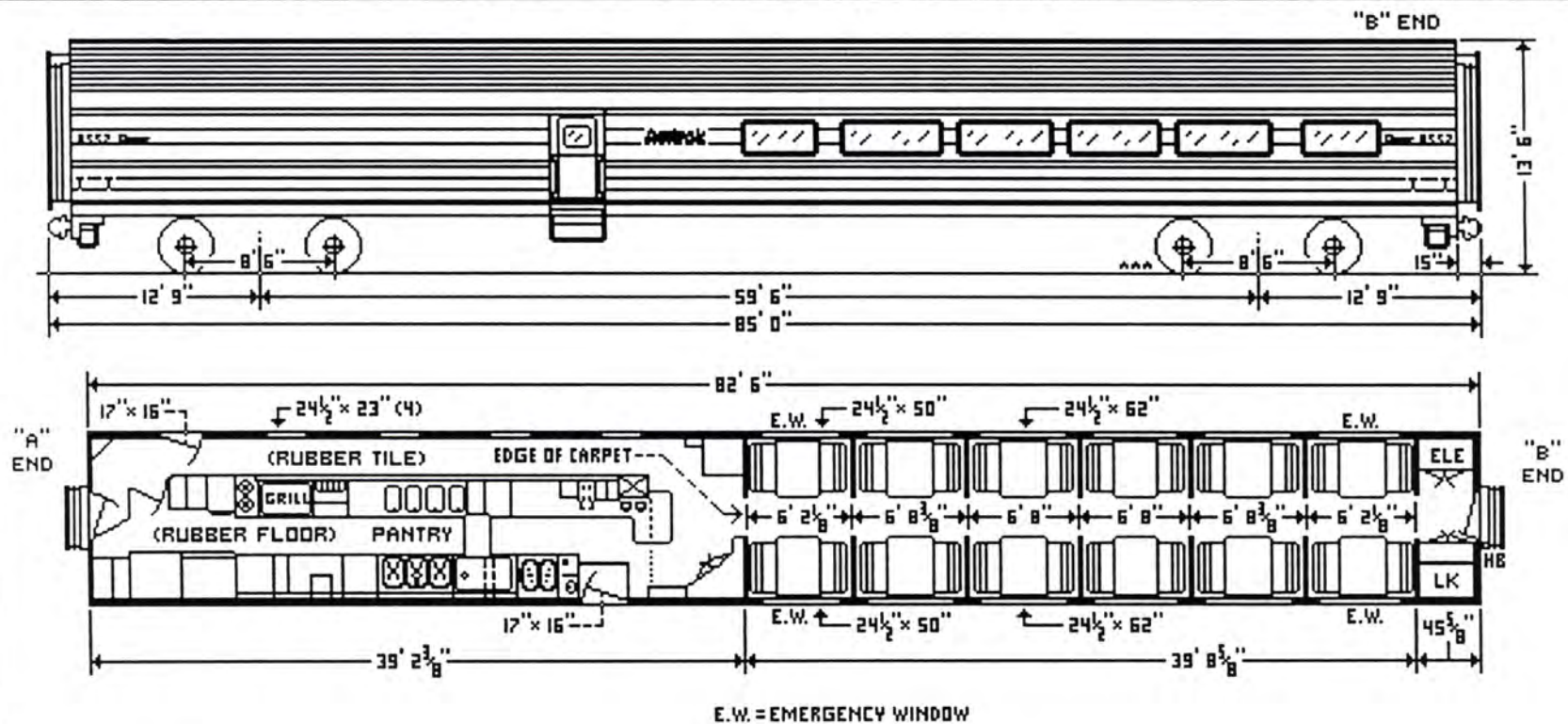

SEATS: 48

HERITAGE DINER GRILL

Equipment Code: DG

110 MPH

Car Nos: 8553, 8554, 8556

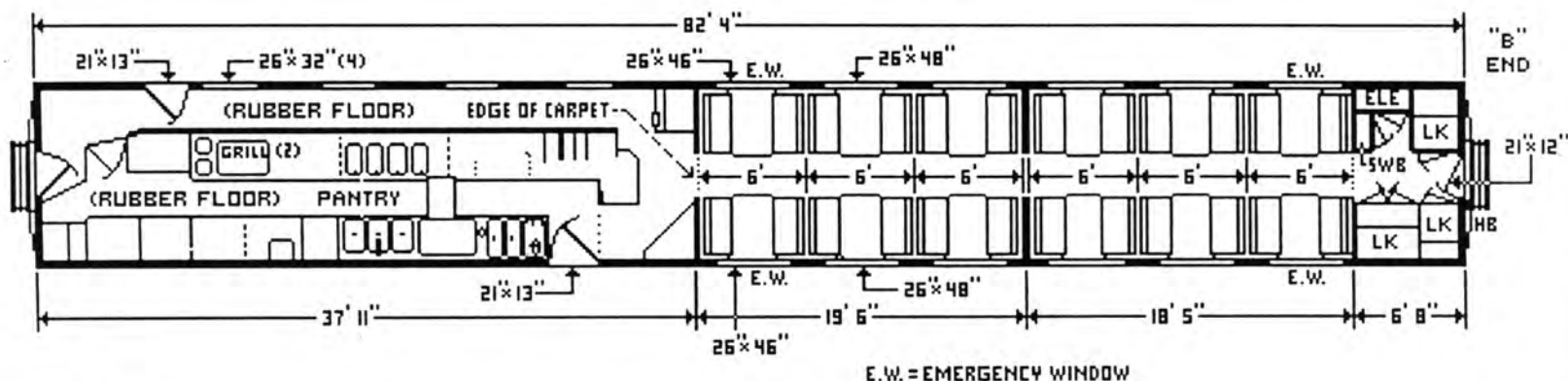
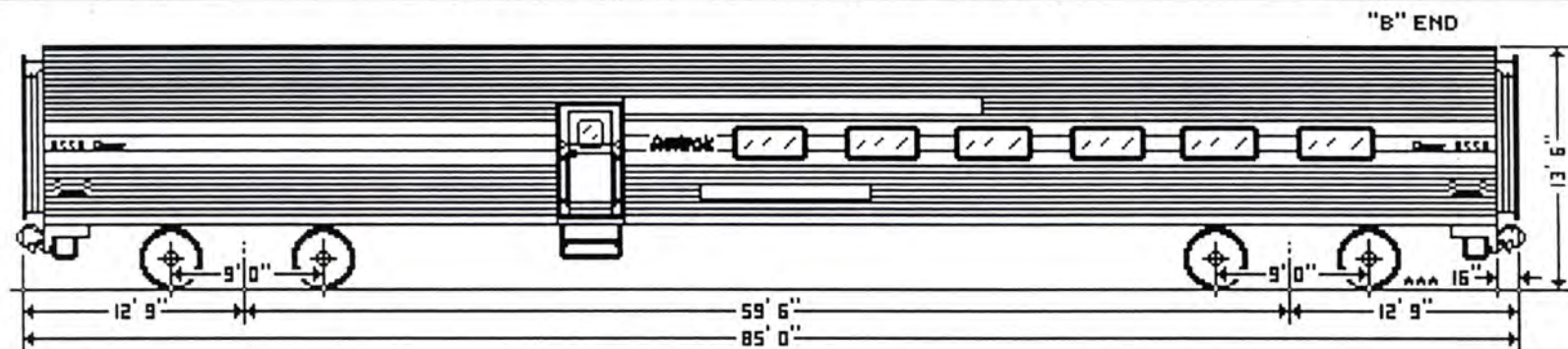

E.W. = EMERGENCY WINDOW

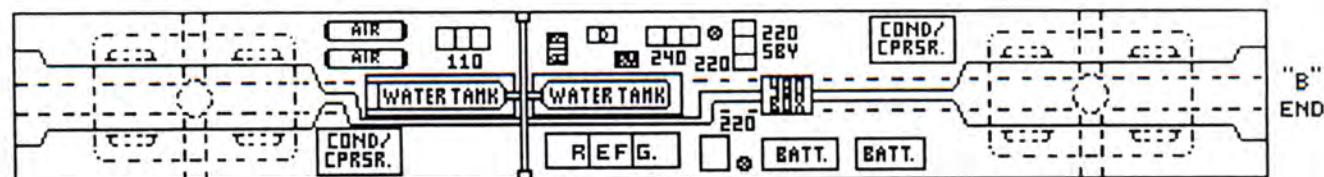
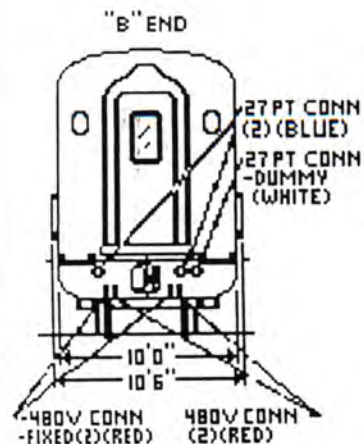

UNDERBODY VIEW THROUGH FLOOR

SEATS: 48

HERITAGE DINER GRILL

Equipment Code: DG

110 MPH

Car Nos: 8557, 8558

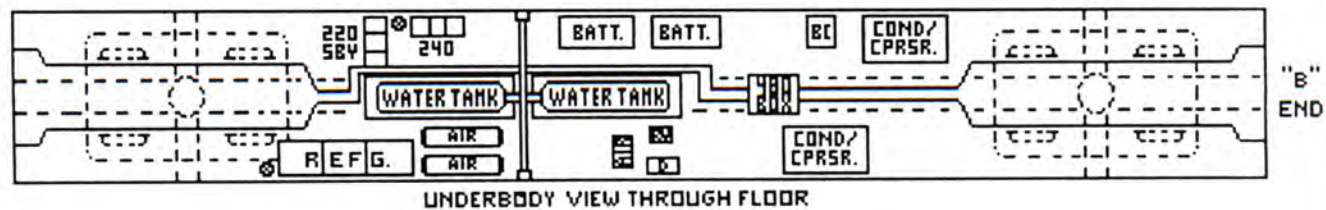
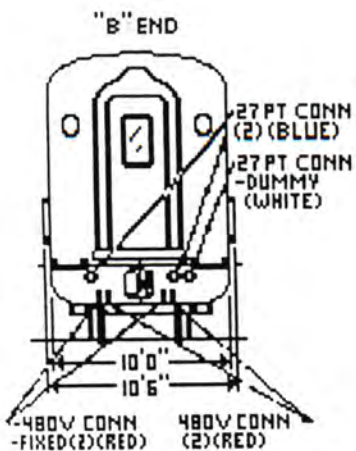
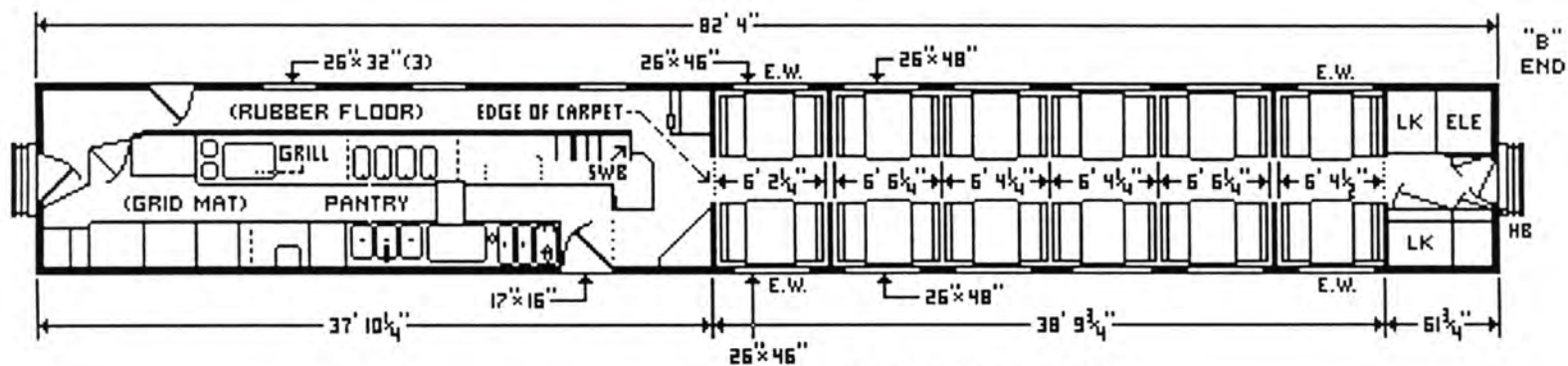
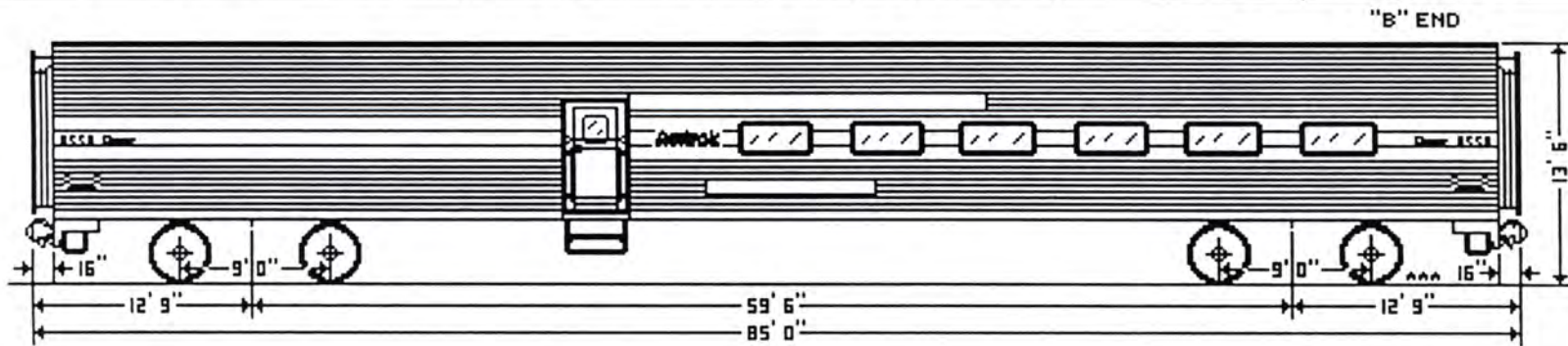

SEATS: 48

HERITAGE TABLE CAR

Equipment Code: FS

110 MPH

Car Numbers: 8600-8603

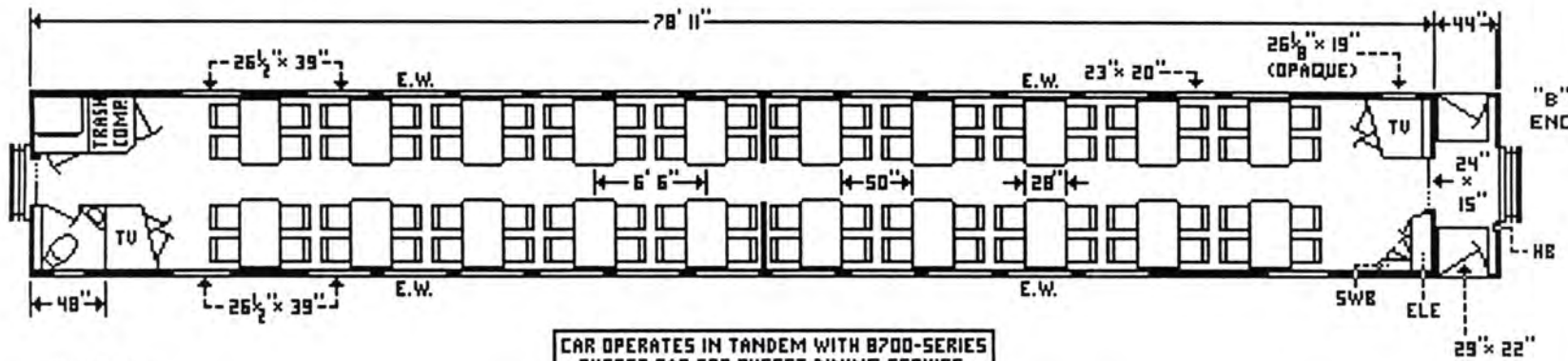
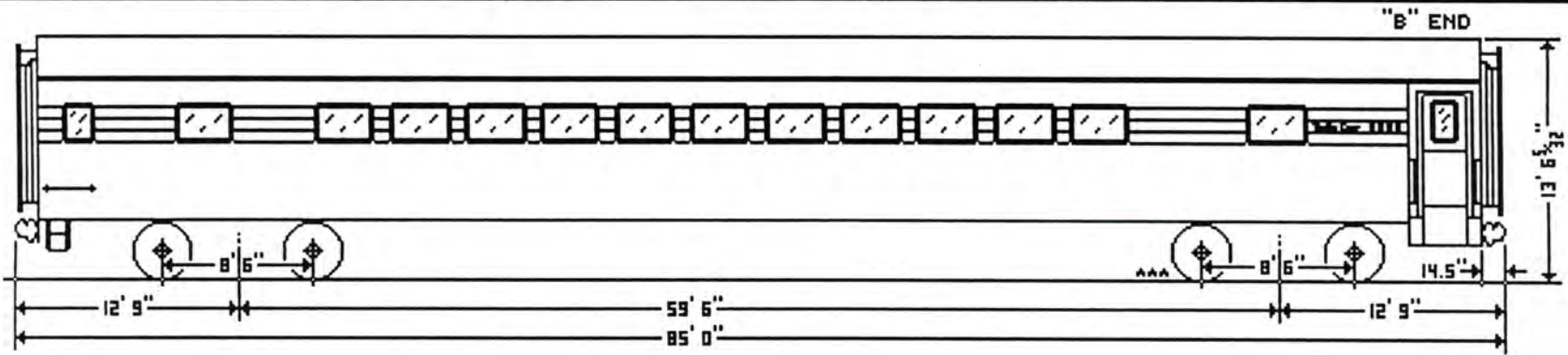

CAR OPERATES IN TANDEM WITH 8700-SERIES BUFFET CAR FOR BUFFET DINING SERVICE.

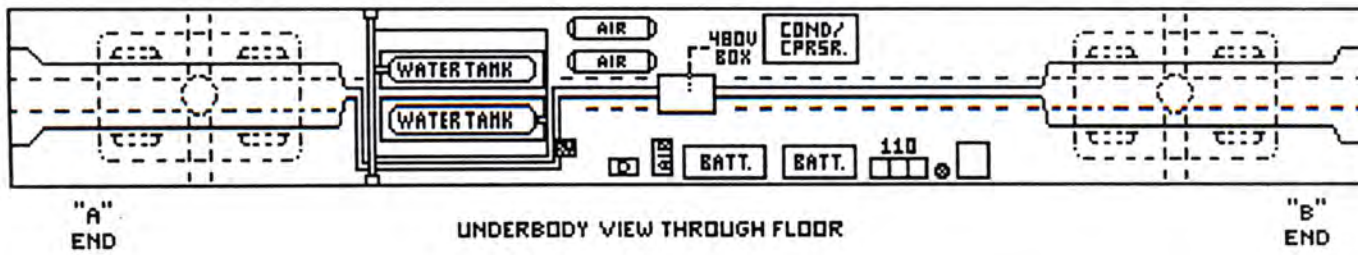
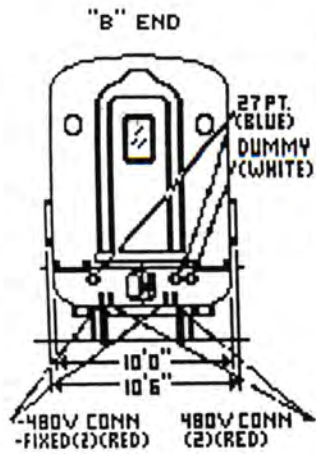

SEATS: 80

HERITAGE BUFFET CAR

Equipment Code: FF

110 MPH

Car Number: 8700

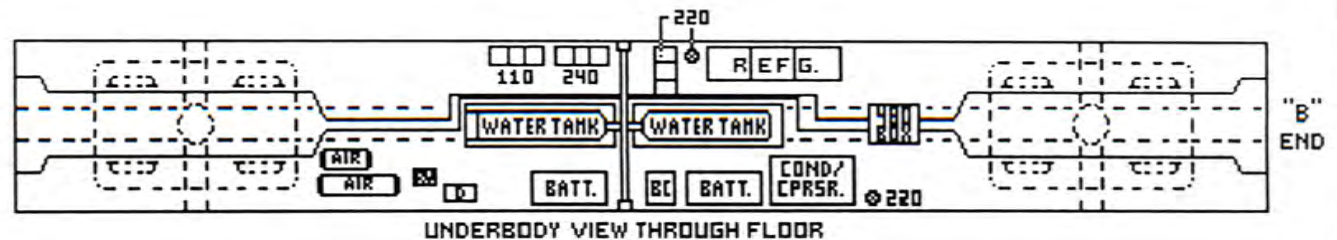
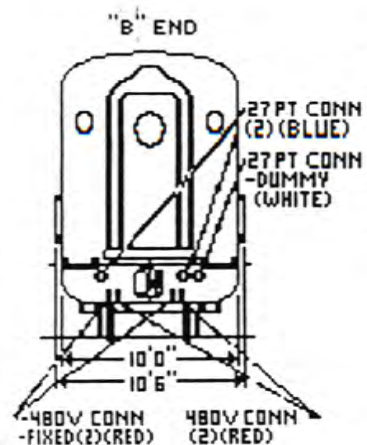
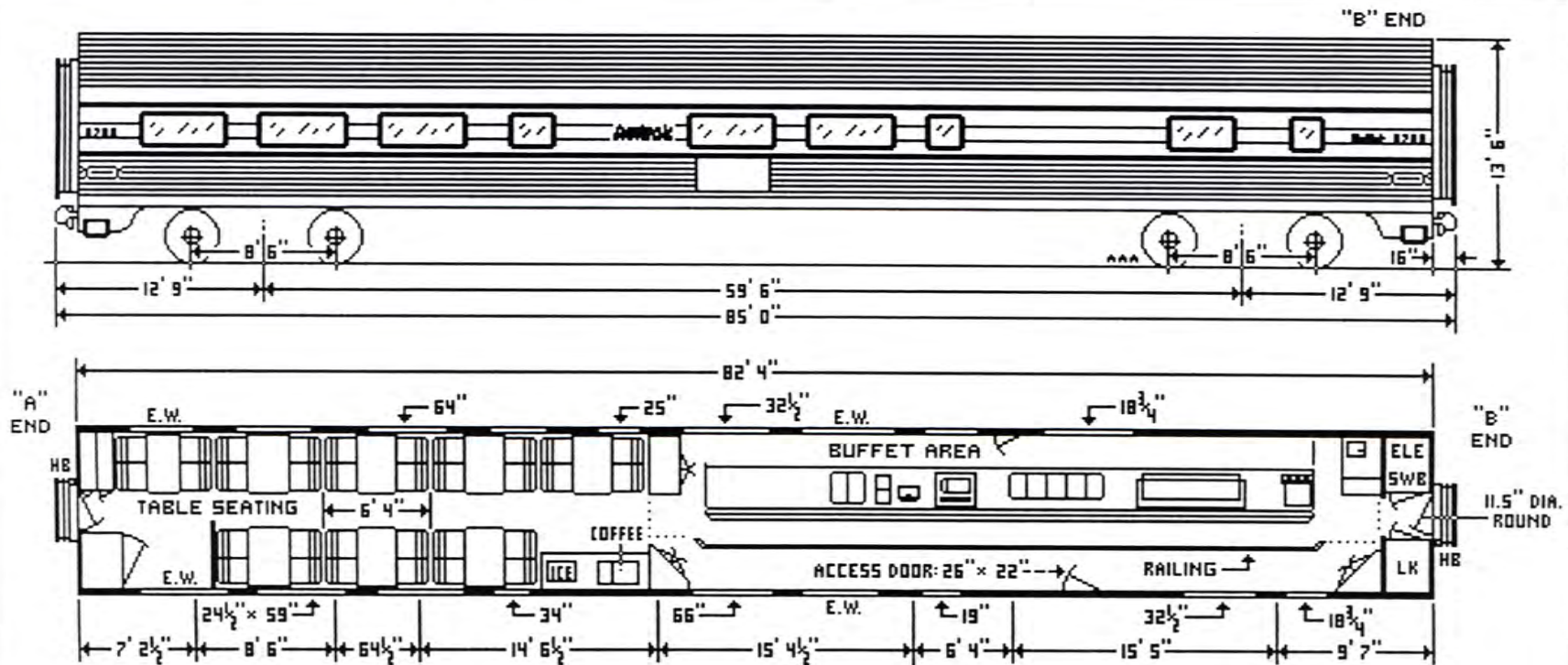

SEATS: 32

HERITAGE BUFFET CAR

Equipment Code: FF

110 MPH

Car Number: 8702

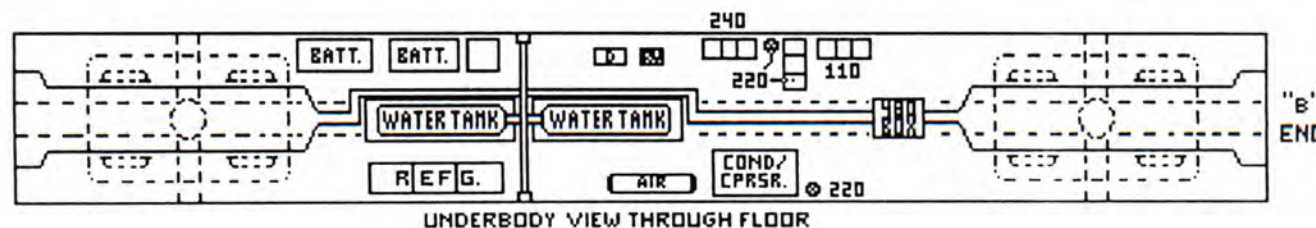
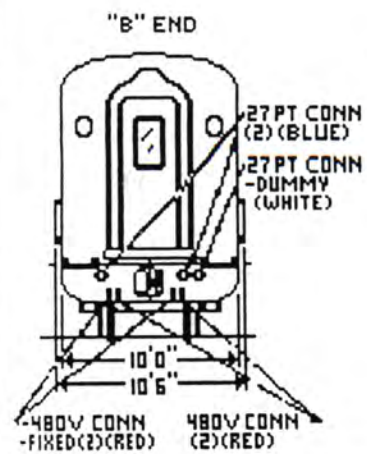
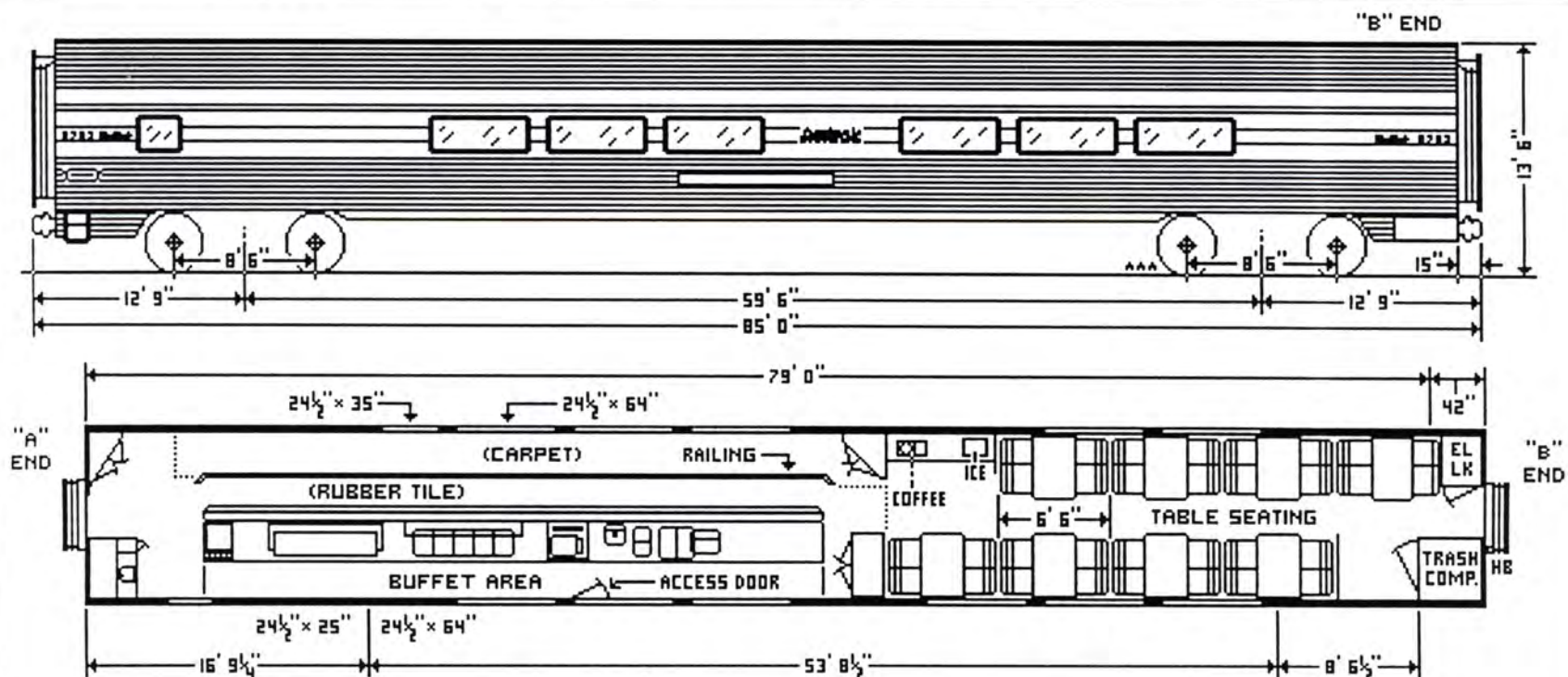

SEATS: 32

HERITAGE BUFFET CAR

Equipment Code: FF

110 MPH

Car Numbers: 8711-8716

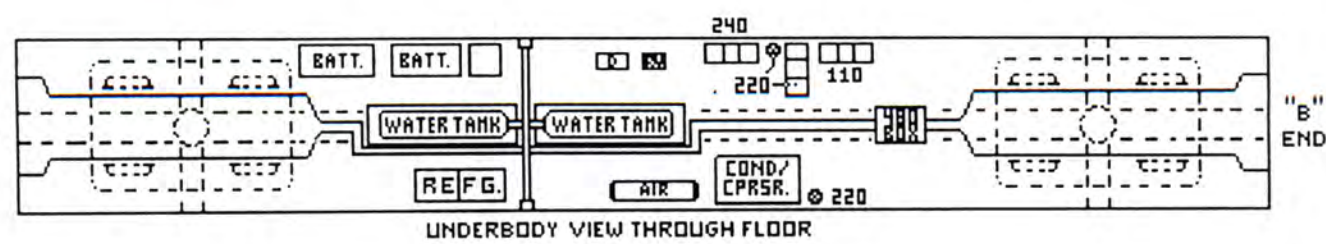
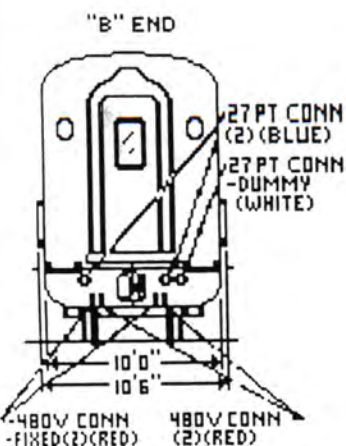
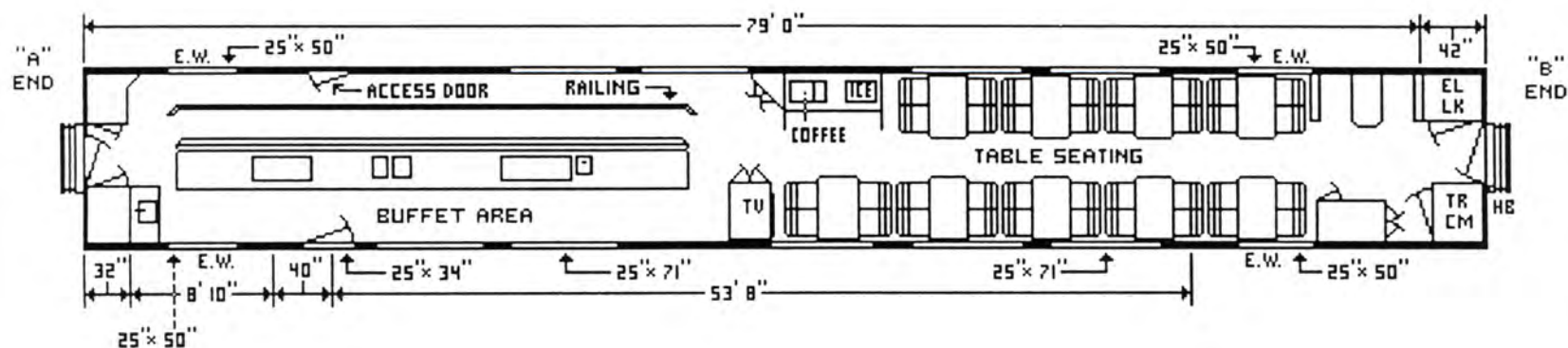
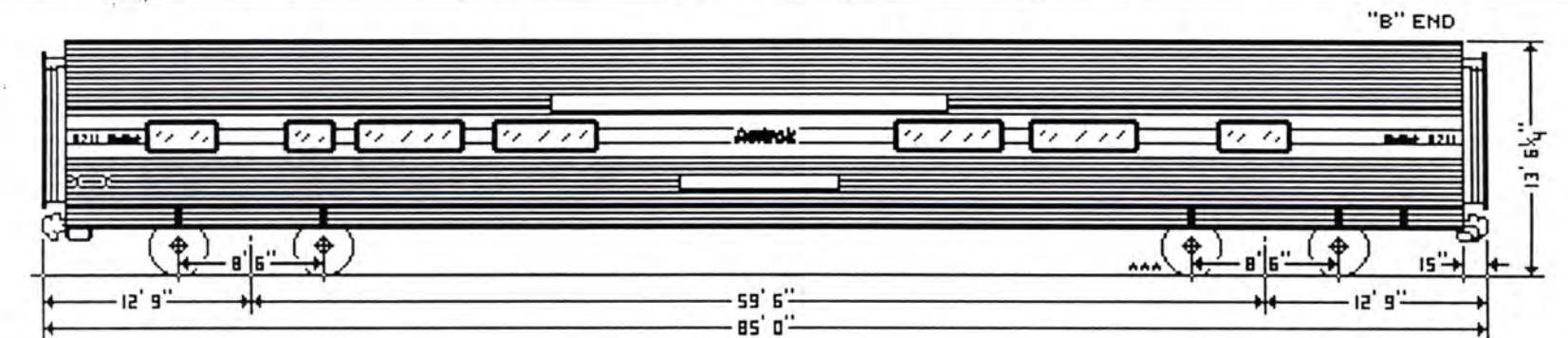

SEATS: 36

HERITAGE KITCHEN BUFFET CAR

Equipment Code: FK

110 MPH

Car Number: 8750

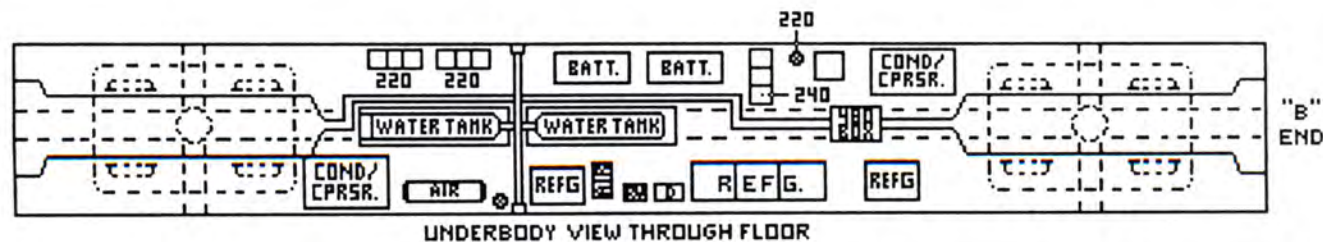
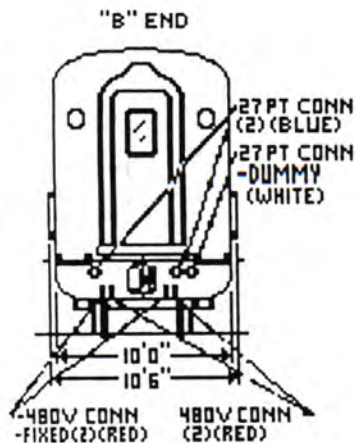
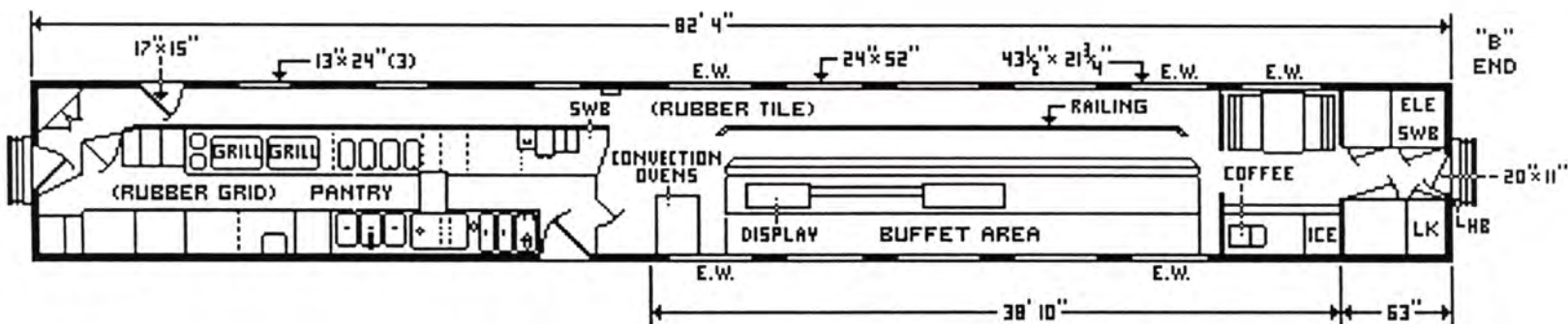
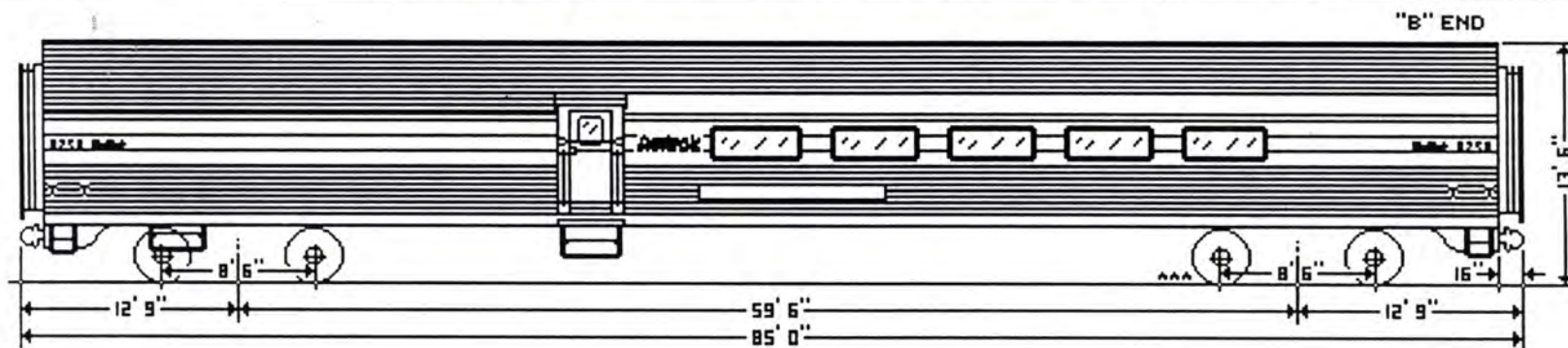

HERITAGE KITCHEN BUFFET CAR

Equipment Code: FK

110 MPH

Car Numbers: 8751, 8752

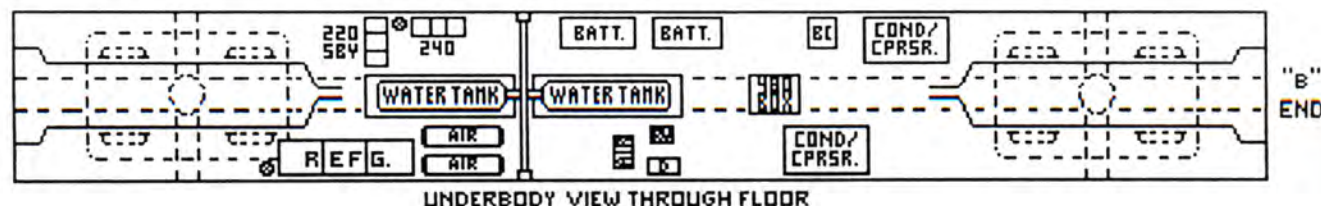
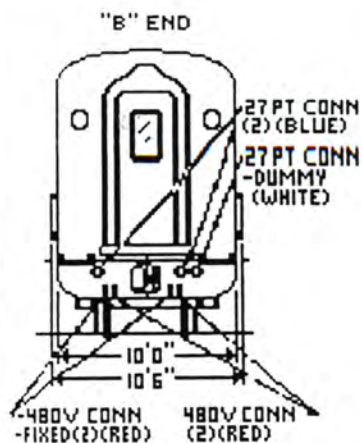
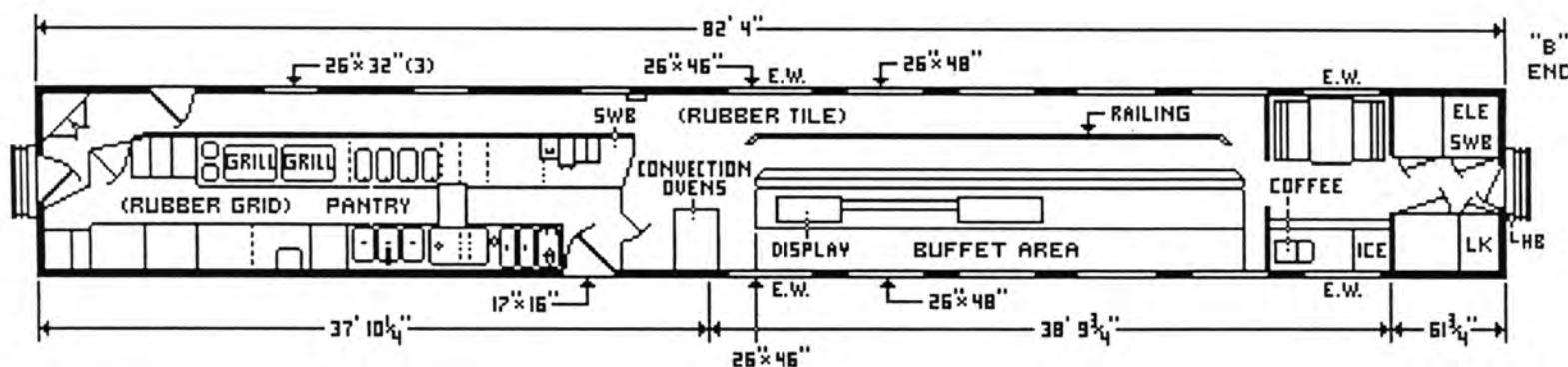
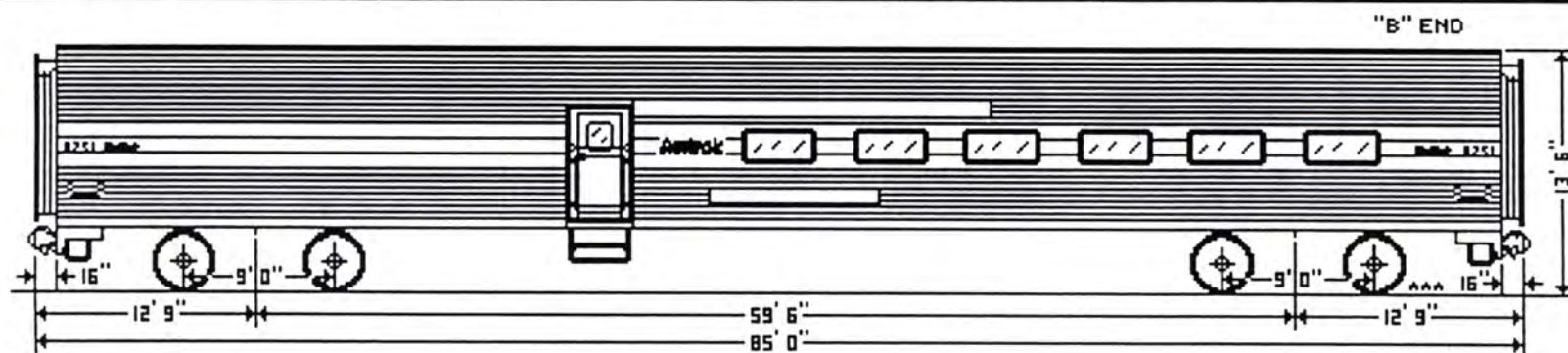

BI-LEVEL AUTO CARRIER

Equipment Code: FB

70 MPH

Car Numbers: 9000-9040

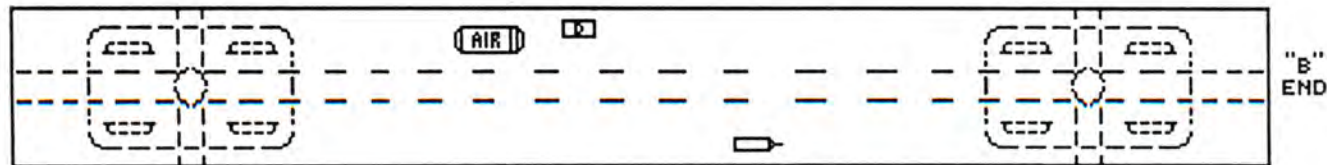
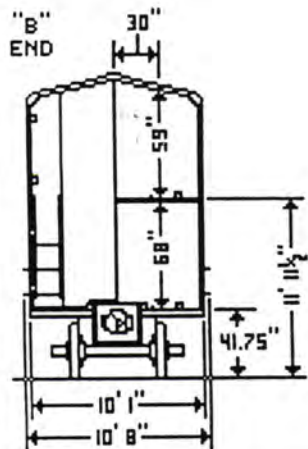
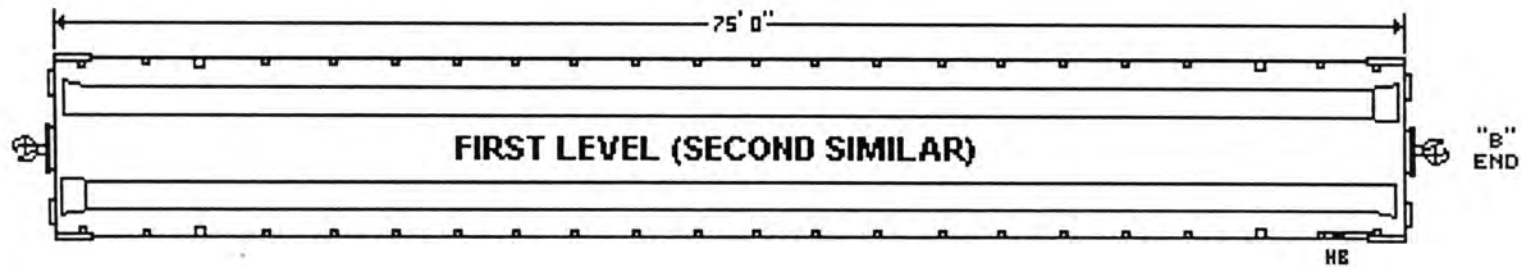
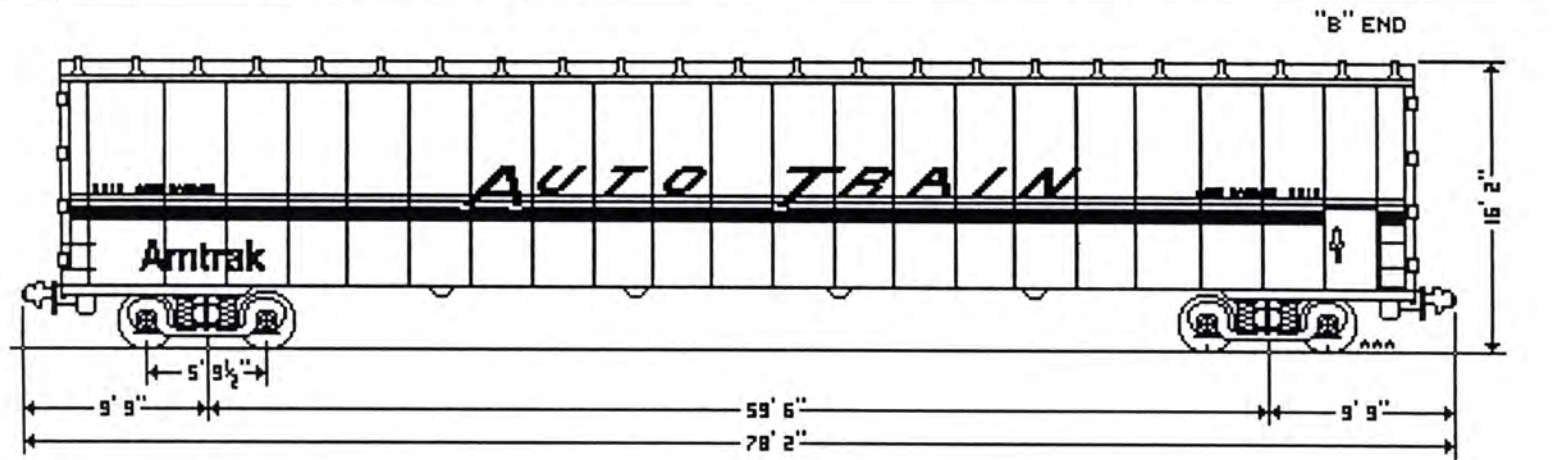

UNDERBODY VIEW THROUGH FLOOR

CAPACITY: 8 AUTOS

BI-LEVEL VAN CARRIER

Equipment Code: FV

70 MPH

Car Numbers: 9090-9095

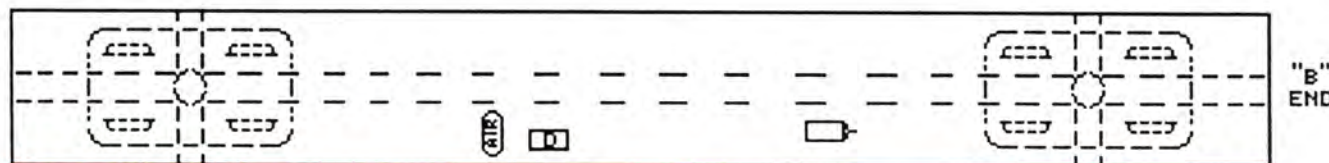
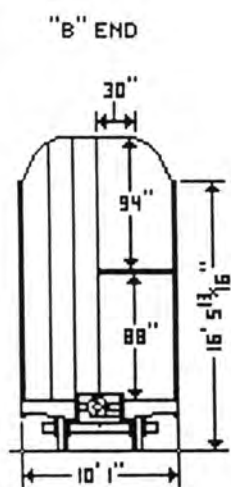
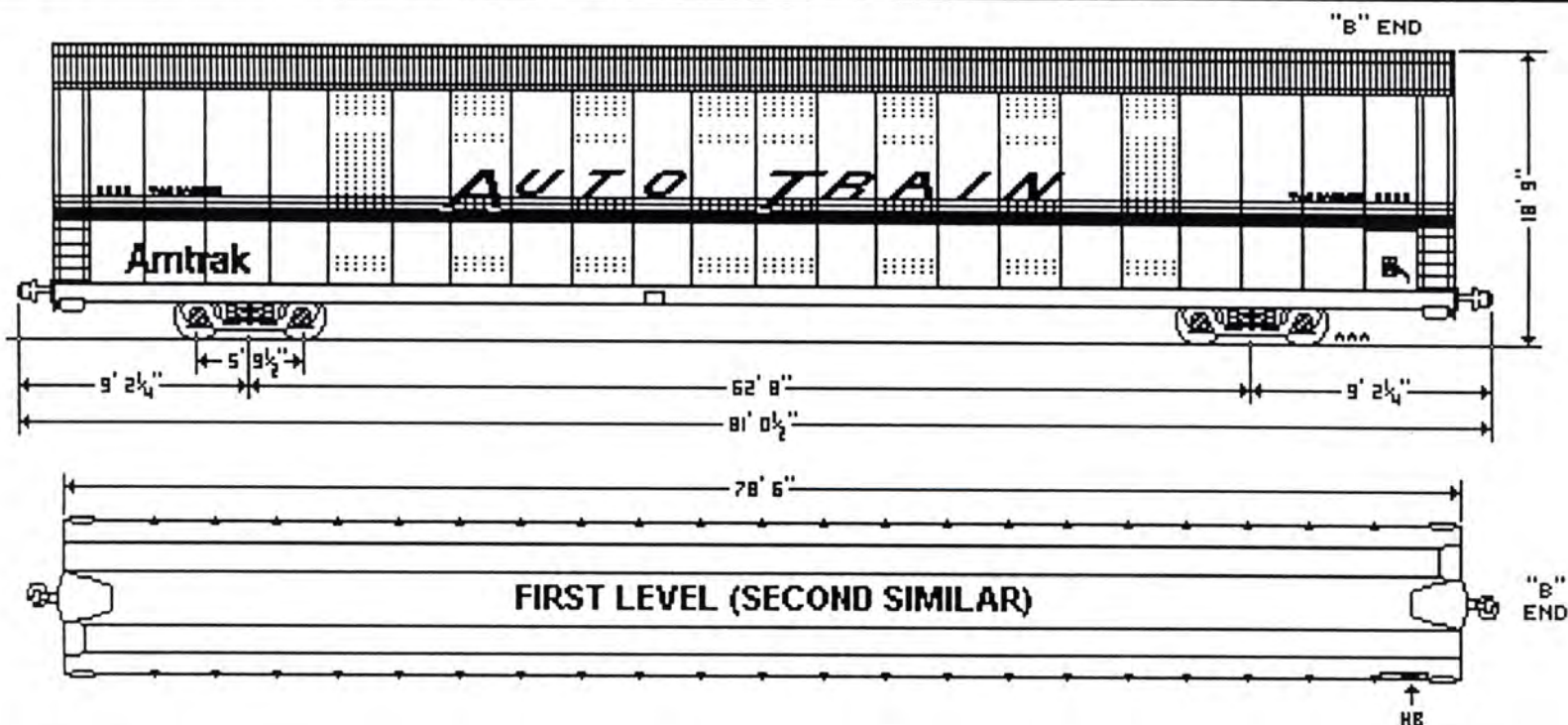

UNDERBODY VIEW THROUGH FLOOR

CAPACITY: 8 VANS

TRI-LEVEL AUTO CARRIER

Equipment Code: FT

70 MPH

Car Numbers: 9100-9123

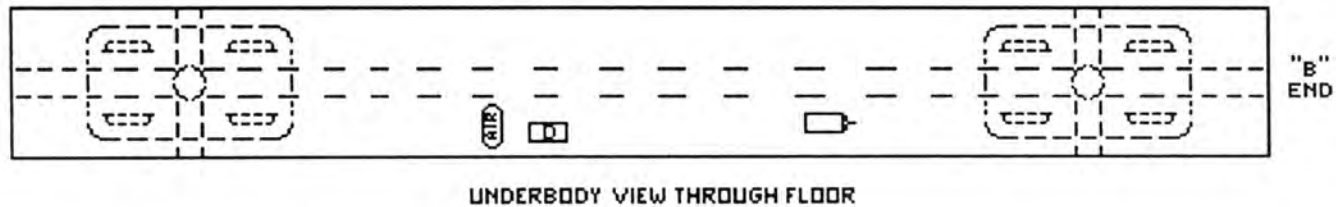
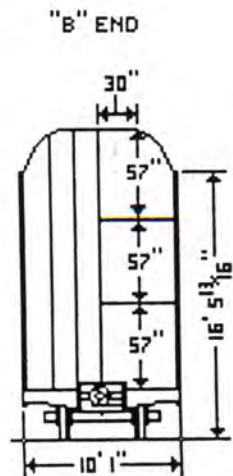
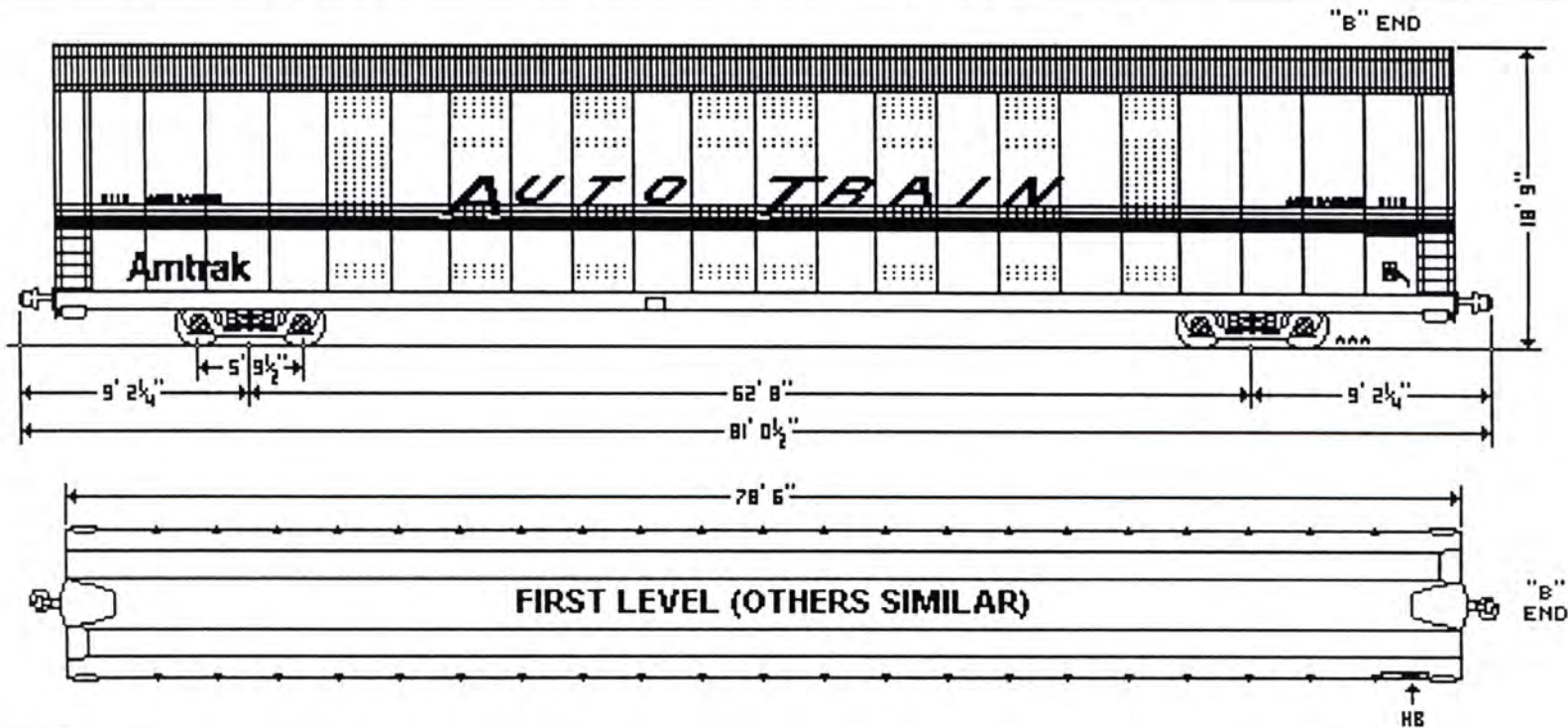

CAPACITY: 12 AUTOS

HERITAGE FULL DOME LOUNGE CAR

Equipment Code: DL

110 MPH

Car Nos: 9300, 9302

SIDE VIEW

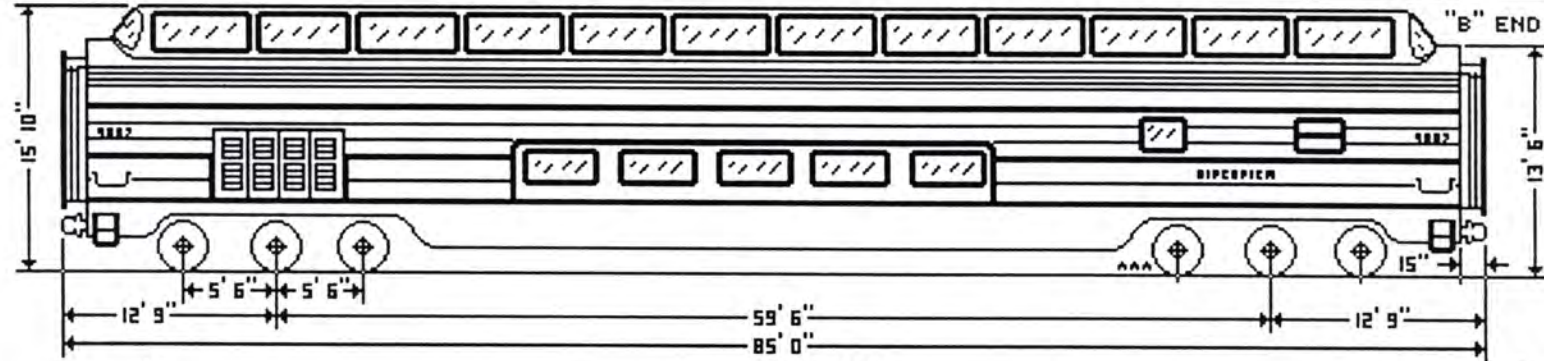

UPPER LEVEL

9300 - OCEAN VIEW
9302 - RIVER VIEW

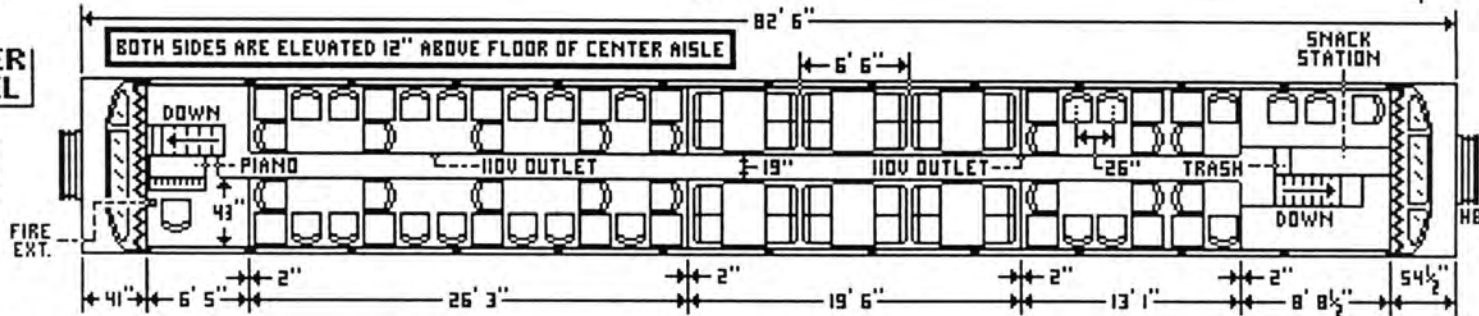

LOWER LEVEL

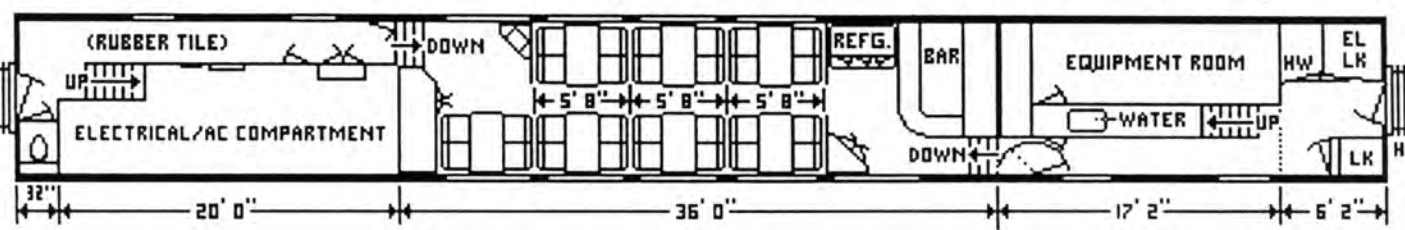

"B" END

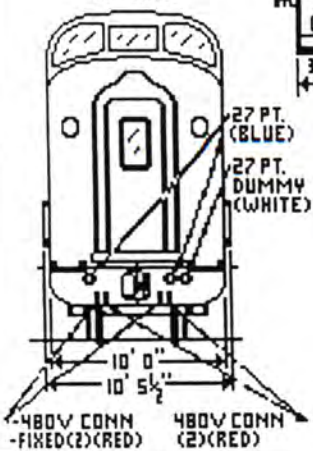

"A" END

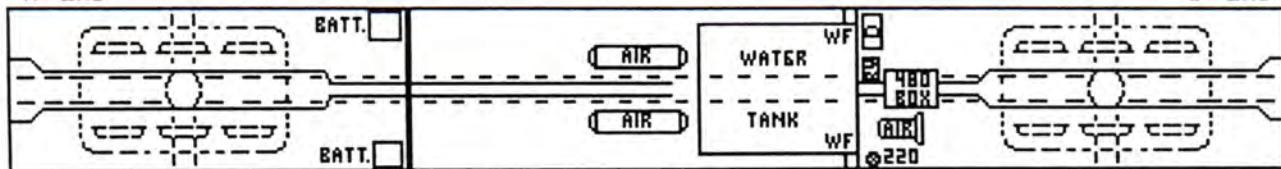

"B" END

**LOUNGE SEATS: 39
TABLE SEATS: 52**

UNDERBODY VIEW THROUGH FLOOR

PUSH-PULL CAB CAR

Equipment Code: CC

125 MPH

Car Numbers: 9630-9639, 9646-9652

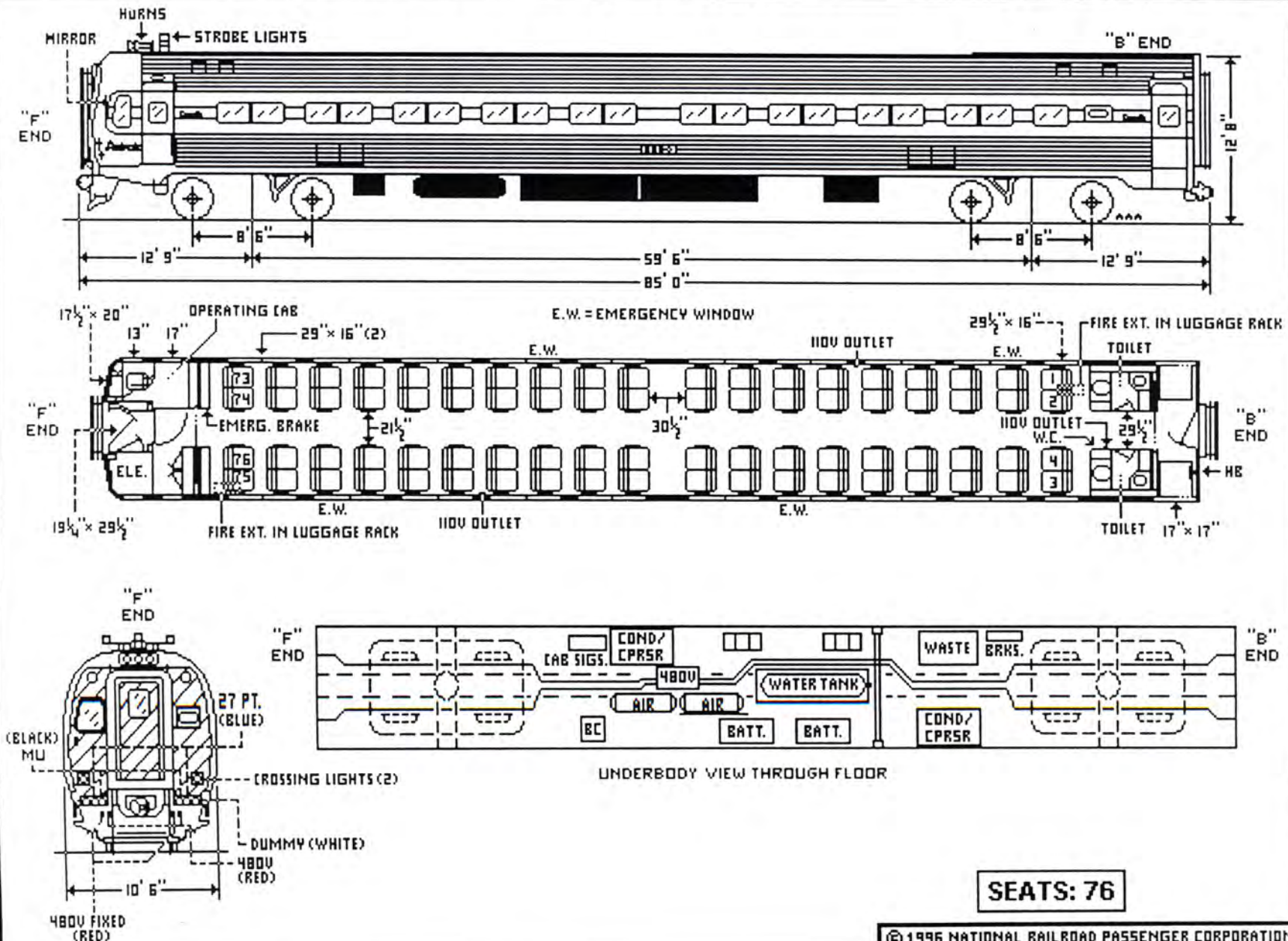

PUSH-PULL CAB CAR

Equipment Code: CC

125 MPH

Car Numbers: 9640, 9642, 9643

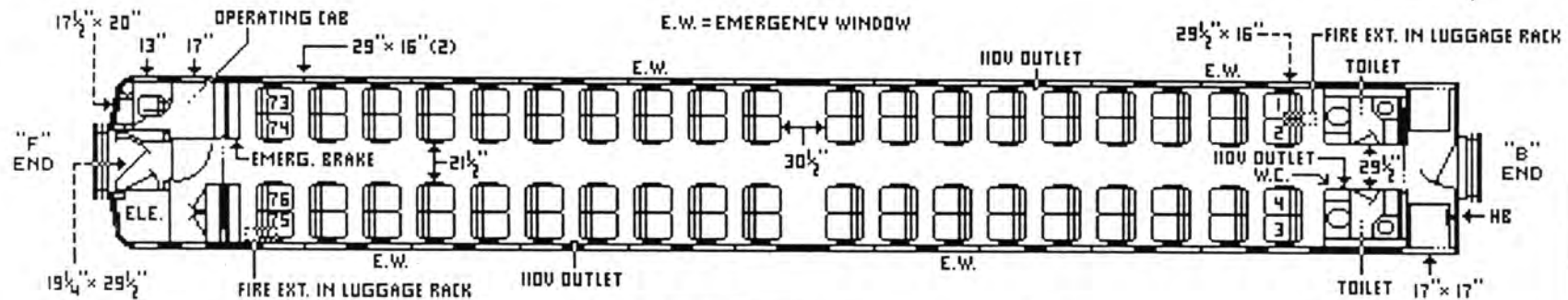
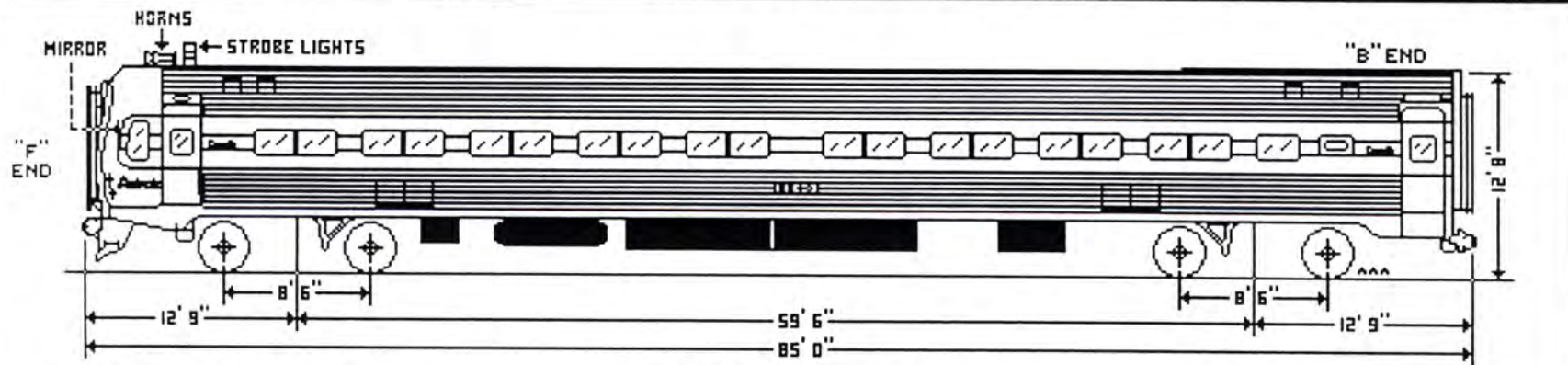

9640: 76 SEATS.
9642, 9643: SEATS 1/2 REMOVED = 74 SEATS.

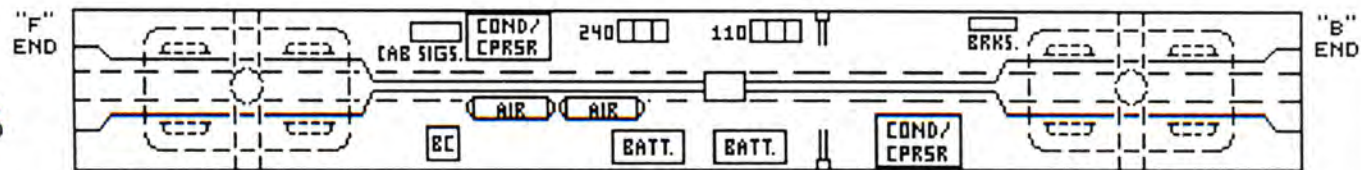
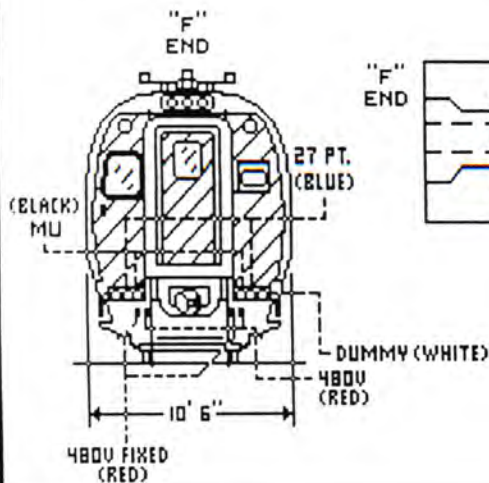

SEATS: 74, 76

PUSH-PULL CAB CAR

Equipment Code: CC

125 MPH

Car Numbers: 9641, 9644, 9645

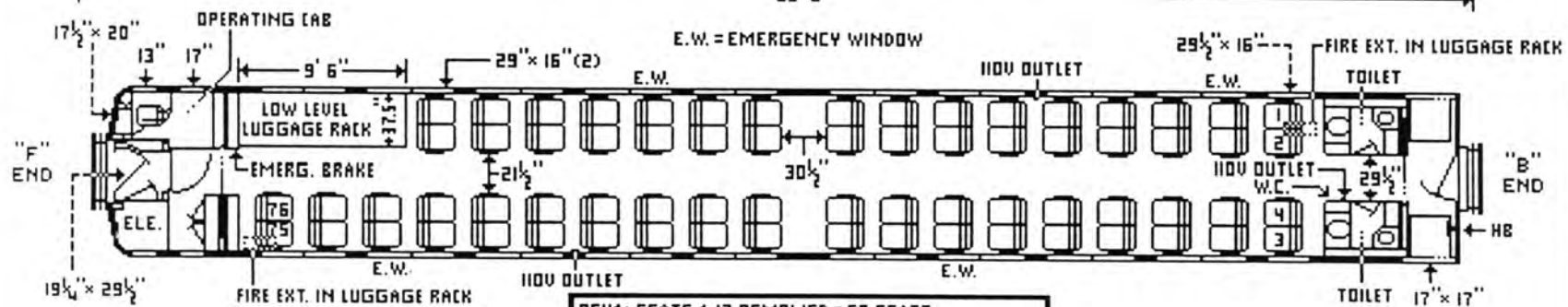
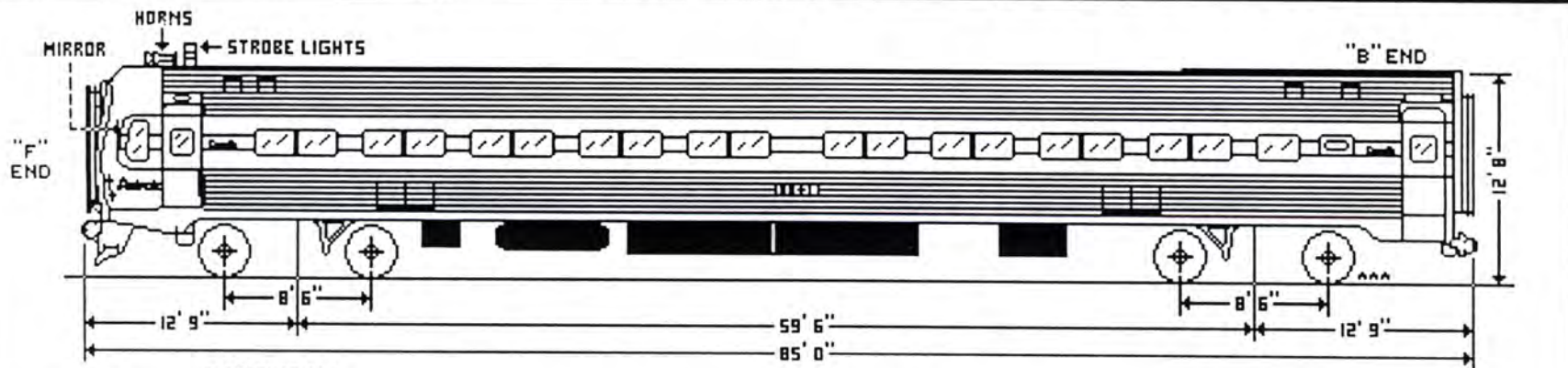

9641: SEATS 1/2 REMOVED = 68 SEATS.
 9644: 70 SEATS.
 9645: SEATS NUMBERED STARTING FROM "F" END.

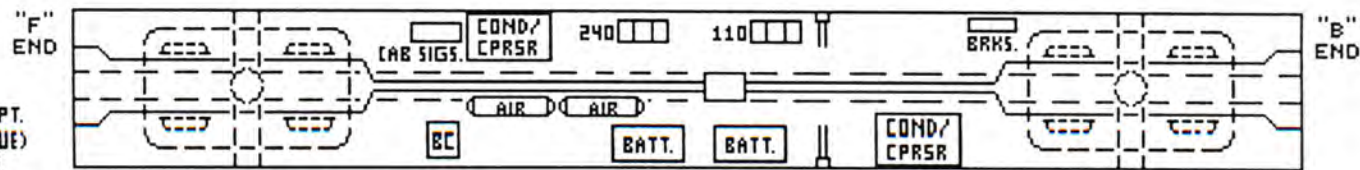
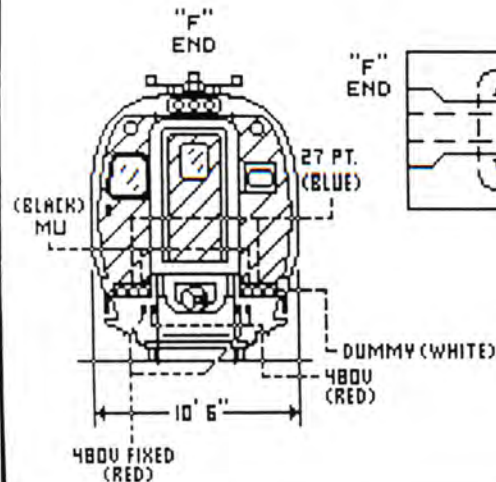

UNDERBODY VIEW THROUGH FLOOR

SEATS: 68, 70

PUSH-PULL CAB "CONFERENCE" CAR

Equipment Code: BF

125 MPH

Car Number: 9800

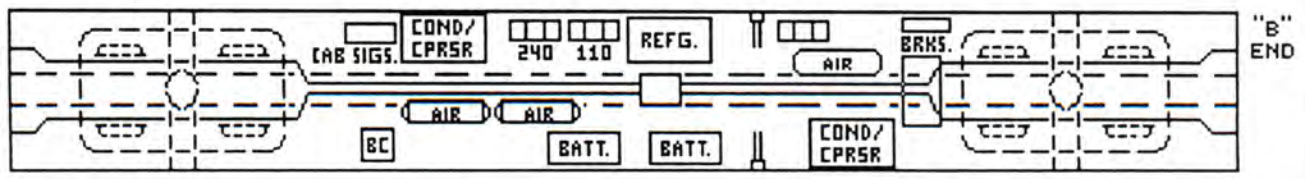
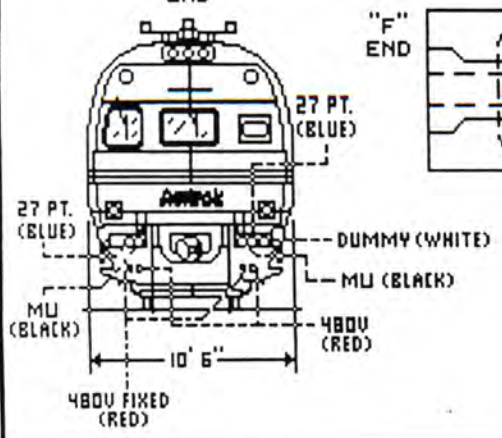
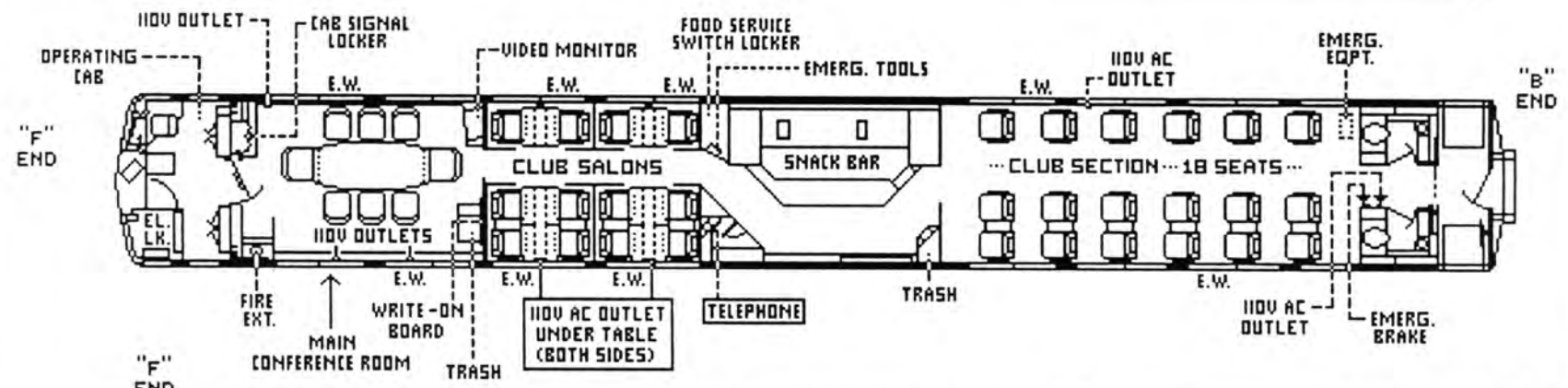
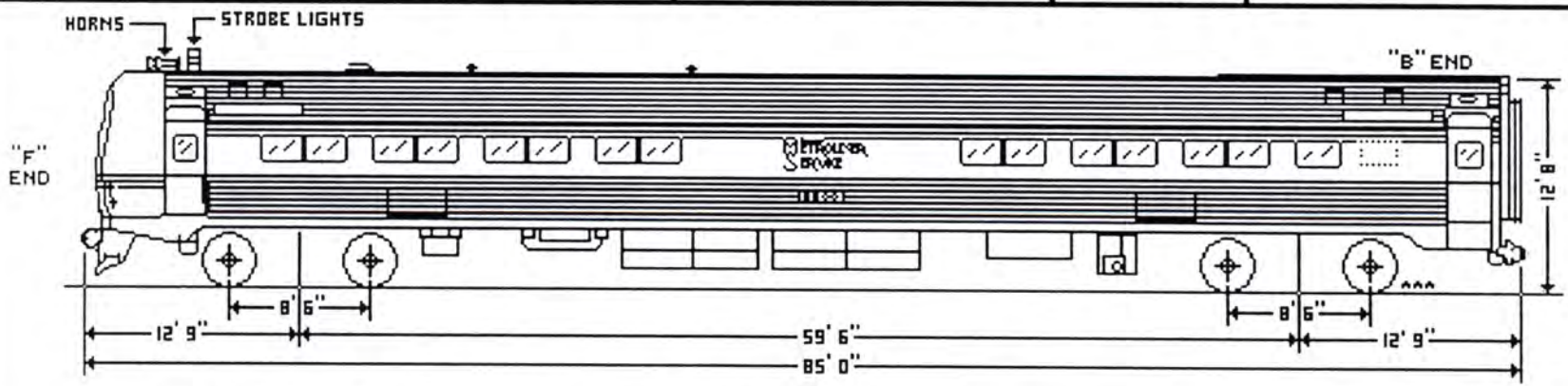

UNDERBODY VIEW THROUGH FLOOR

CLUB SEATS : 18
CLUB SALONS: 12

PUSH-PULL CAB CAR

Equipment Code: CC

125 MPH

Car Numbers: 9826-9828

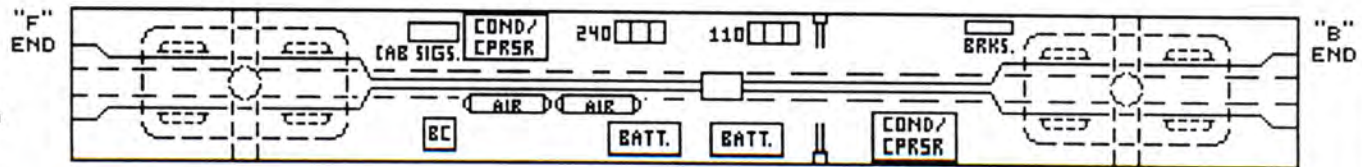
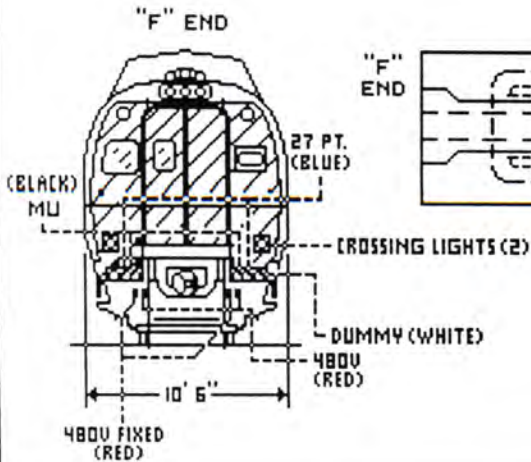
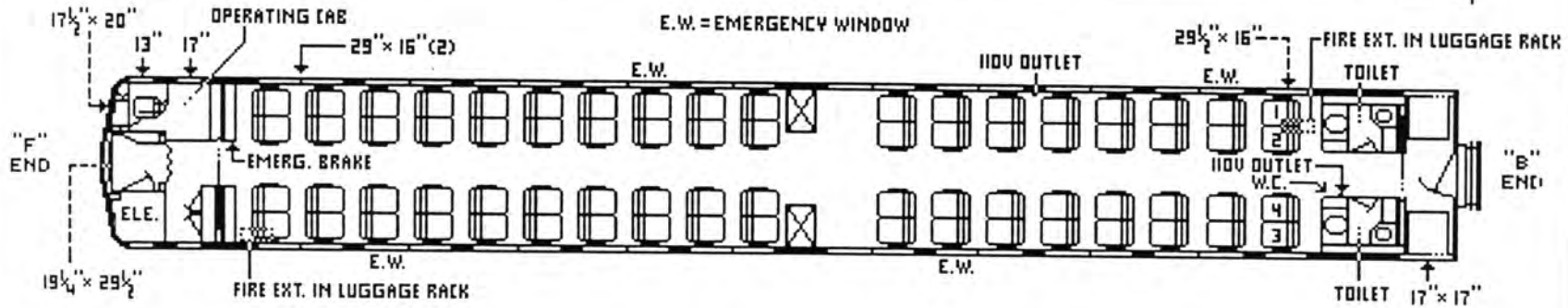
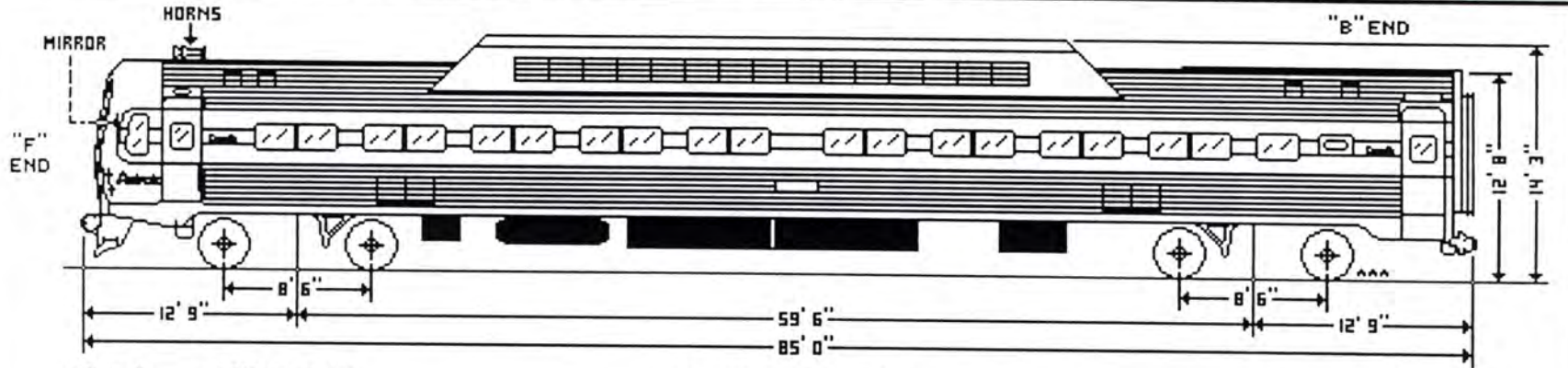

SEATS: 72

INSPECTION CAR "BEECH GROVE"

Equipment Code: TI

125 MPH

Car Number : 10001

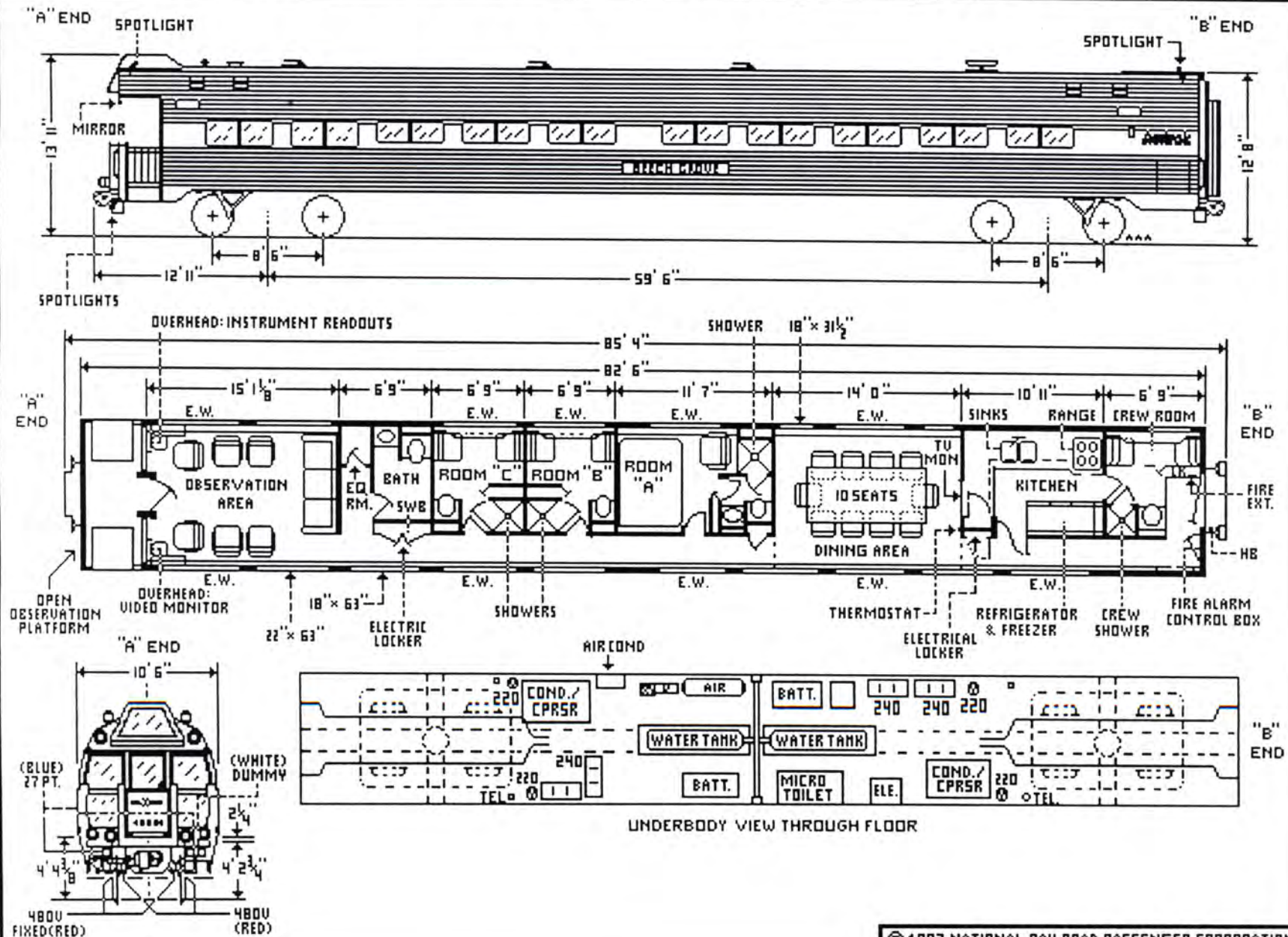

TRACK INSPECTION CAR "CORRIDOR CLIPPER"

Eqpt. Code: TI

125 MPH

Car Number : 10002

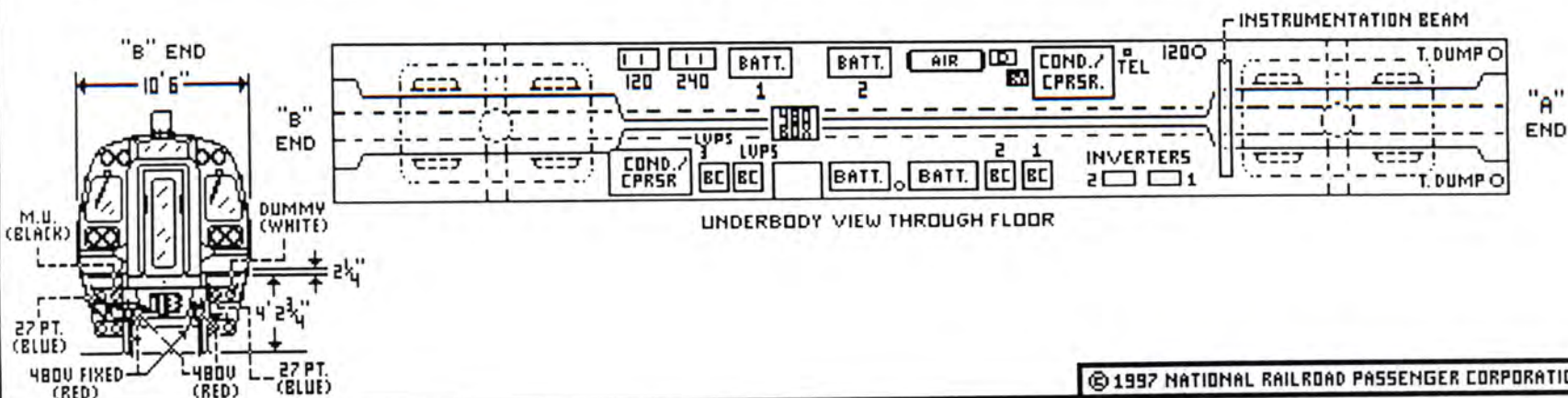
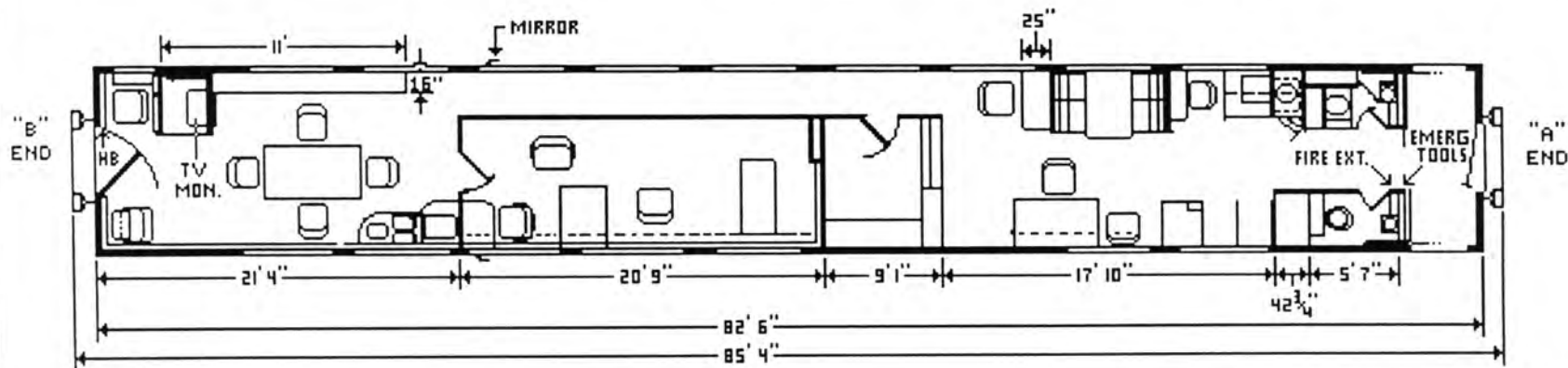
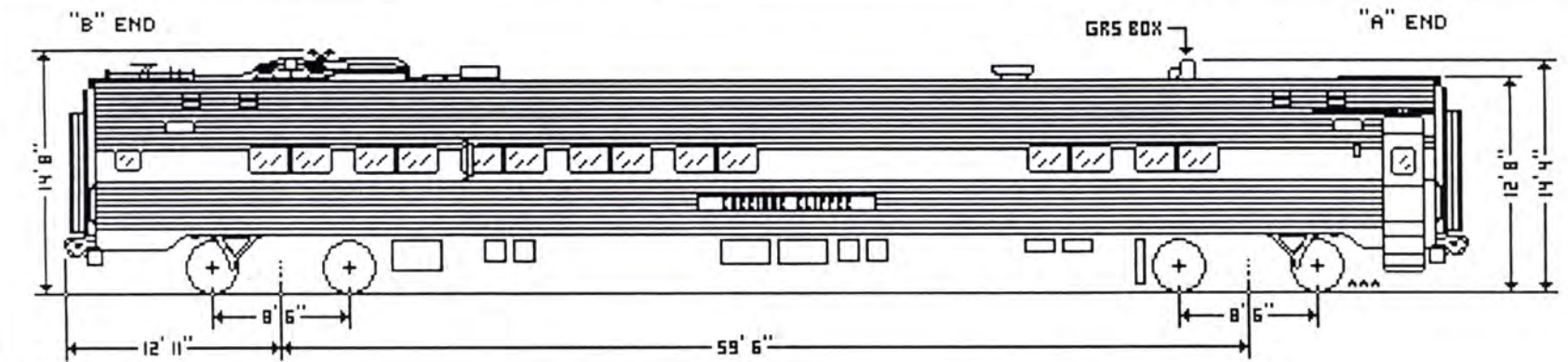

HERITAGE FULL DOME LOUNGE CAR

Equipment Code: DL

110 MPH

Car Number: 10030

SIDE VIEW

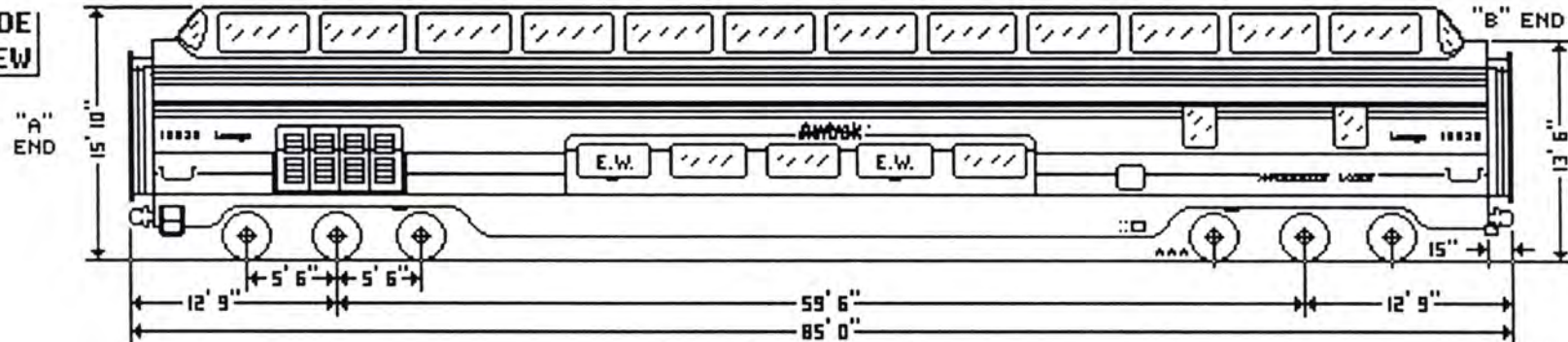

UPPER LEVEL

10030 - MOUNTAIN VIEW

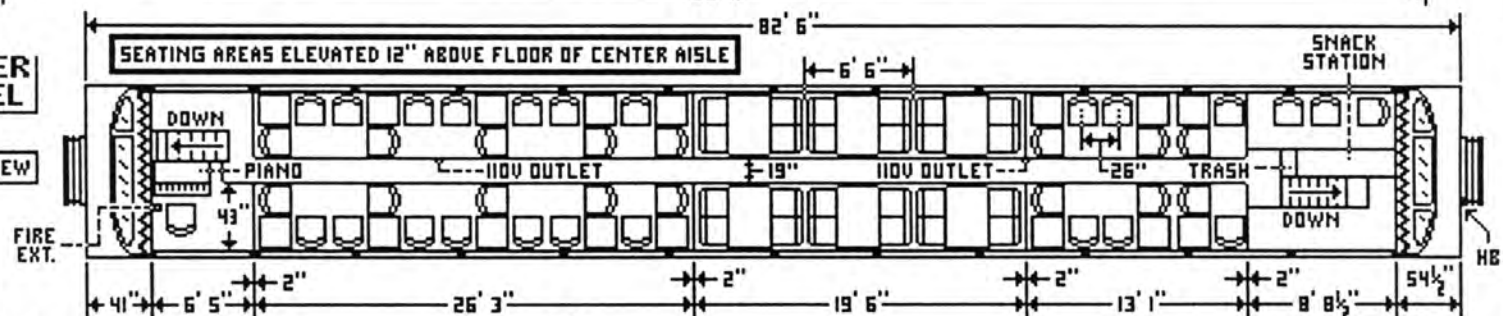

LOWER LEVEL

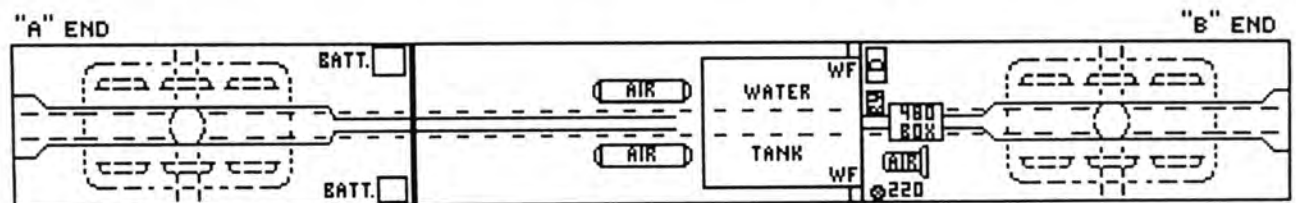
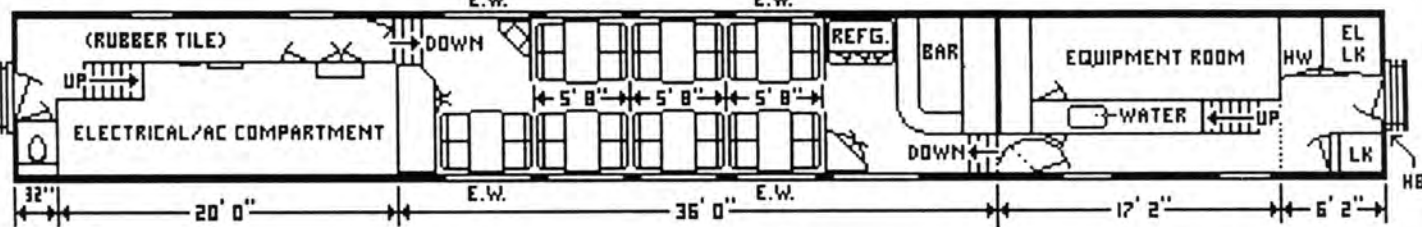
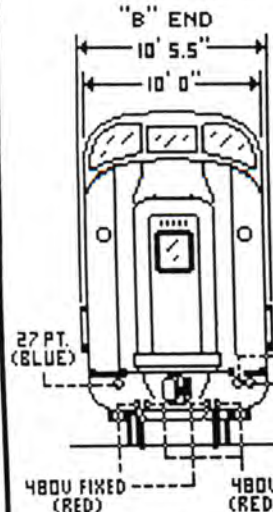

LOUNGE SEATS: 39
TABLE SEATS: 52

UNDERBODY VIEW THROUGH FLOOR

EXHIBIT CAR "SILVER CHEST"

Equipment Code: NR

110 MPH

Car Number : 10090

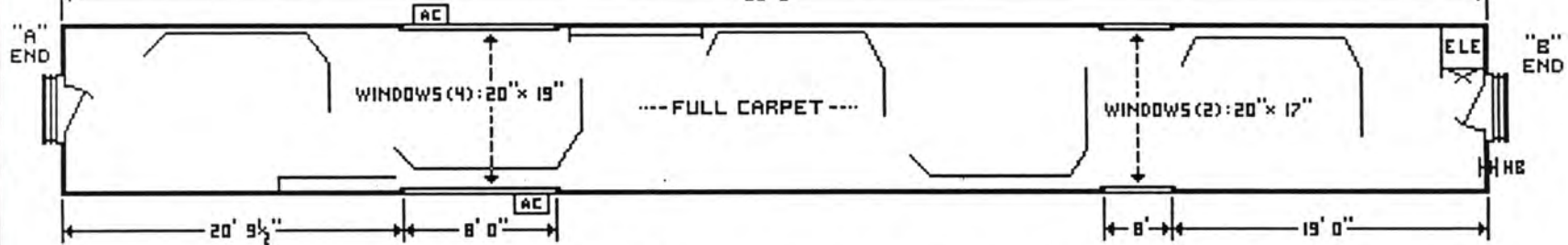
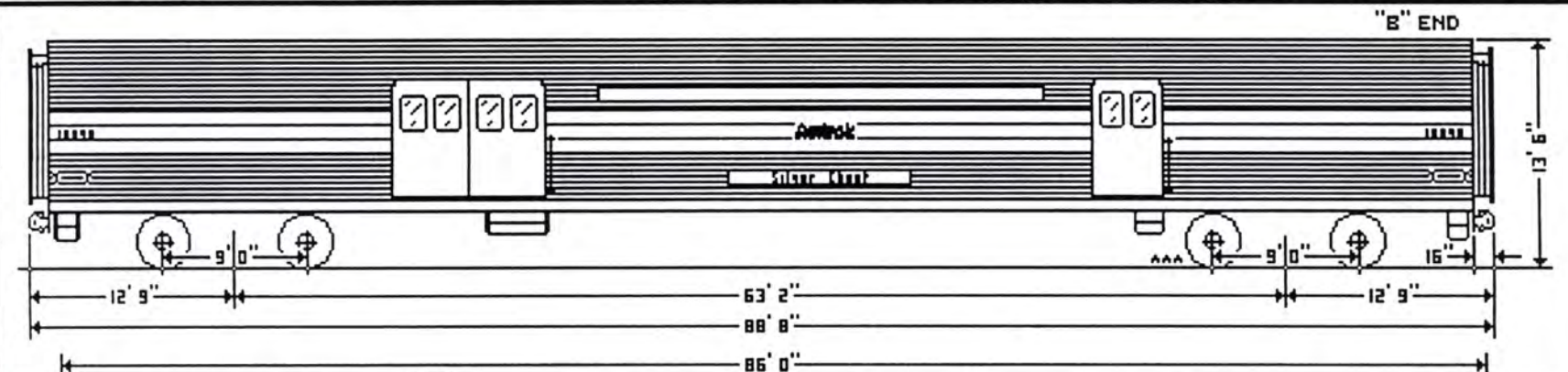

CAR INTERIOR CONTAINS DISPLAYS/DIDRAMAS ILLUSTRATING AMTRAK'S HISTORY.

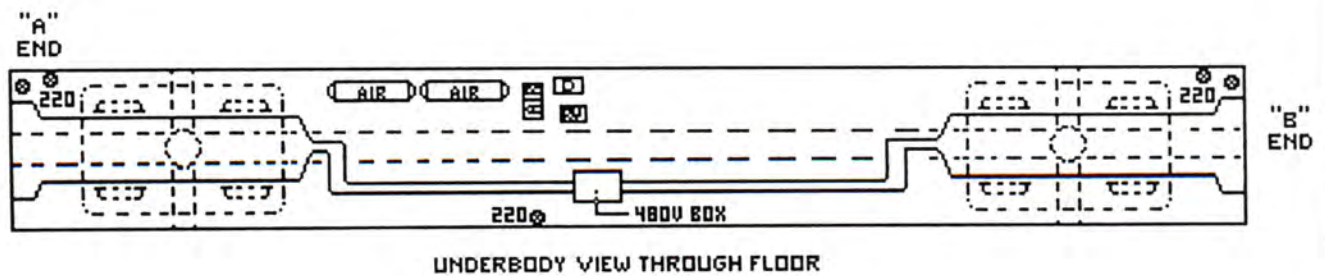
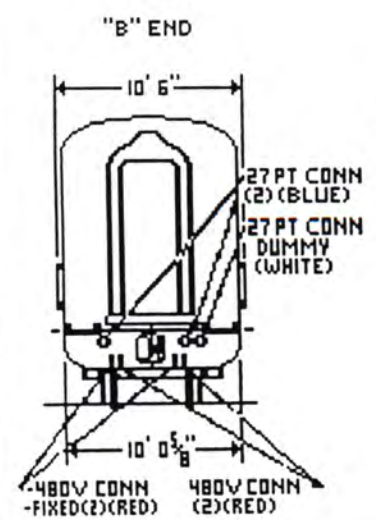

EXHIBIT CAR "SILVER PEAK"

Equipment Code: NR

110 MPH

Car Number : 10091

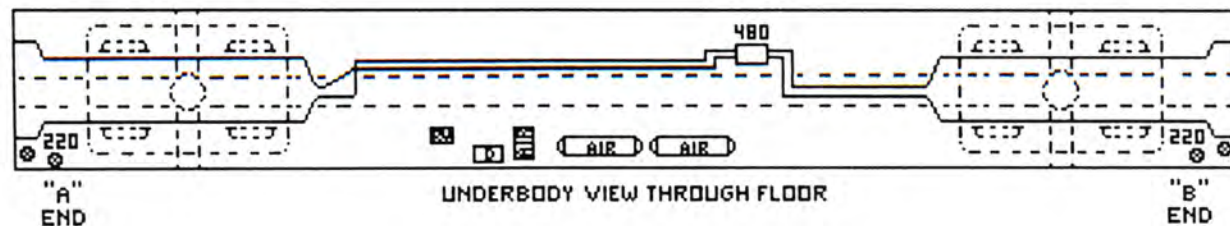
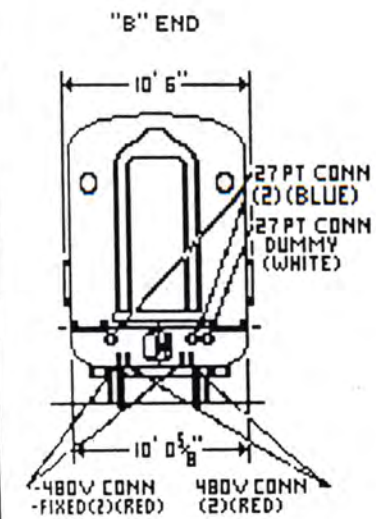
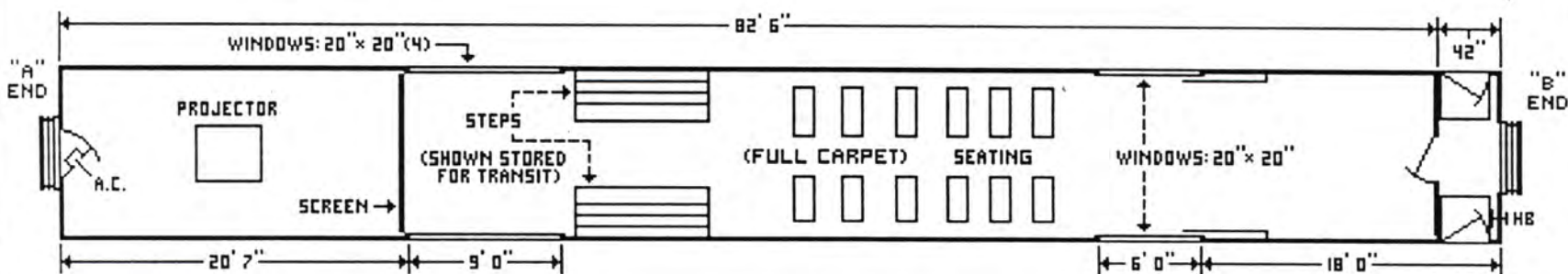
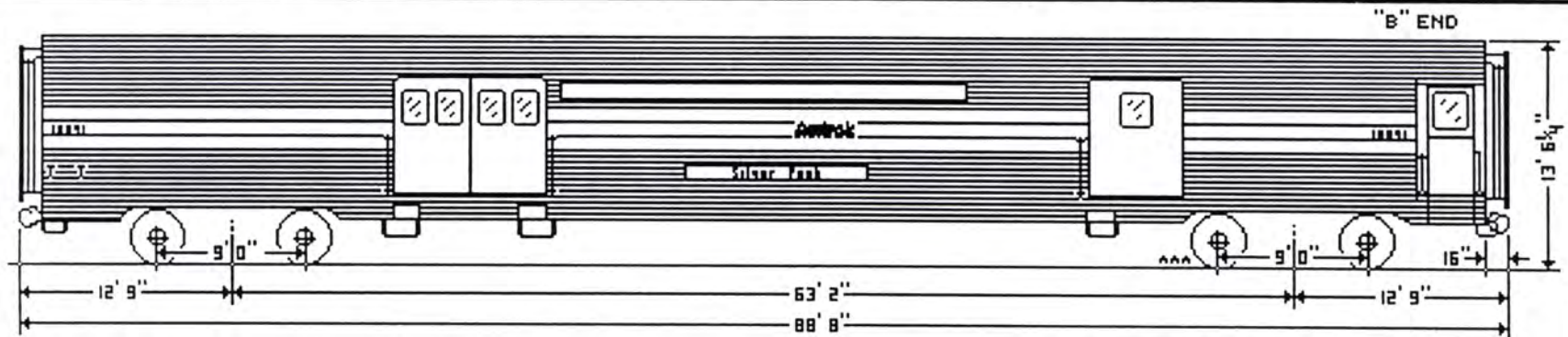
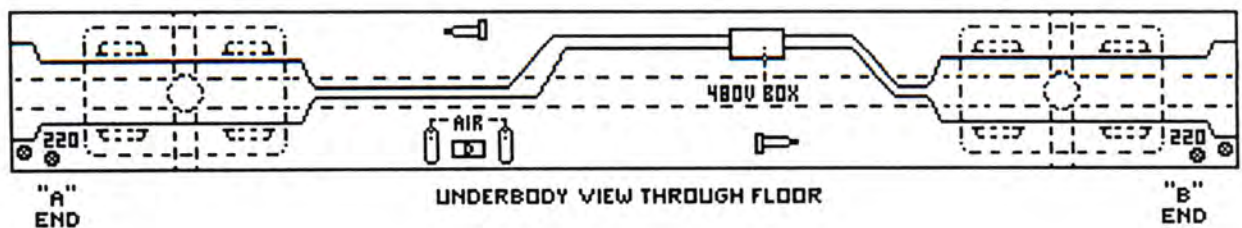
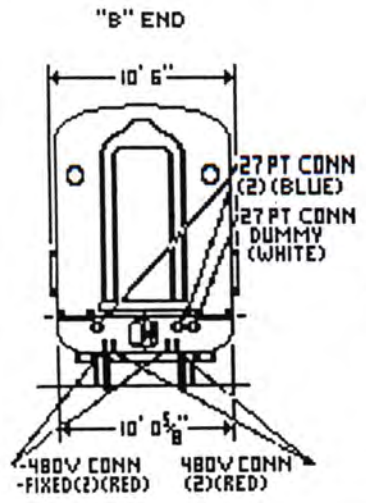
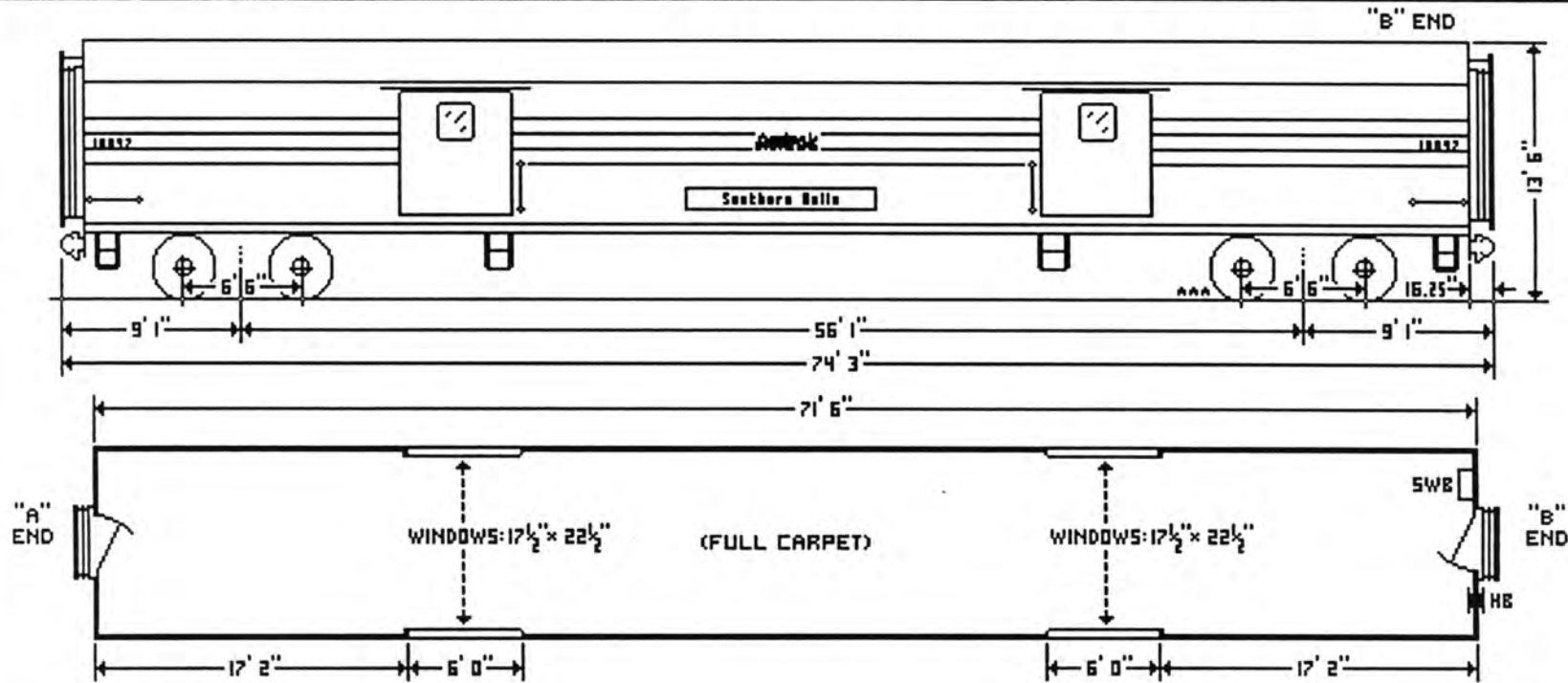

EXHIBIT CAR "SOUTHERN BELLE"

Equipment Code: NR

110 MPH

Car Number : 10092



TECHNICAL TRAINING CAR 10501

Equipment Code: TR

110 MPH

Car Number : 10501

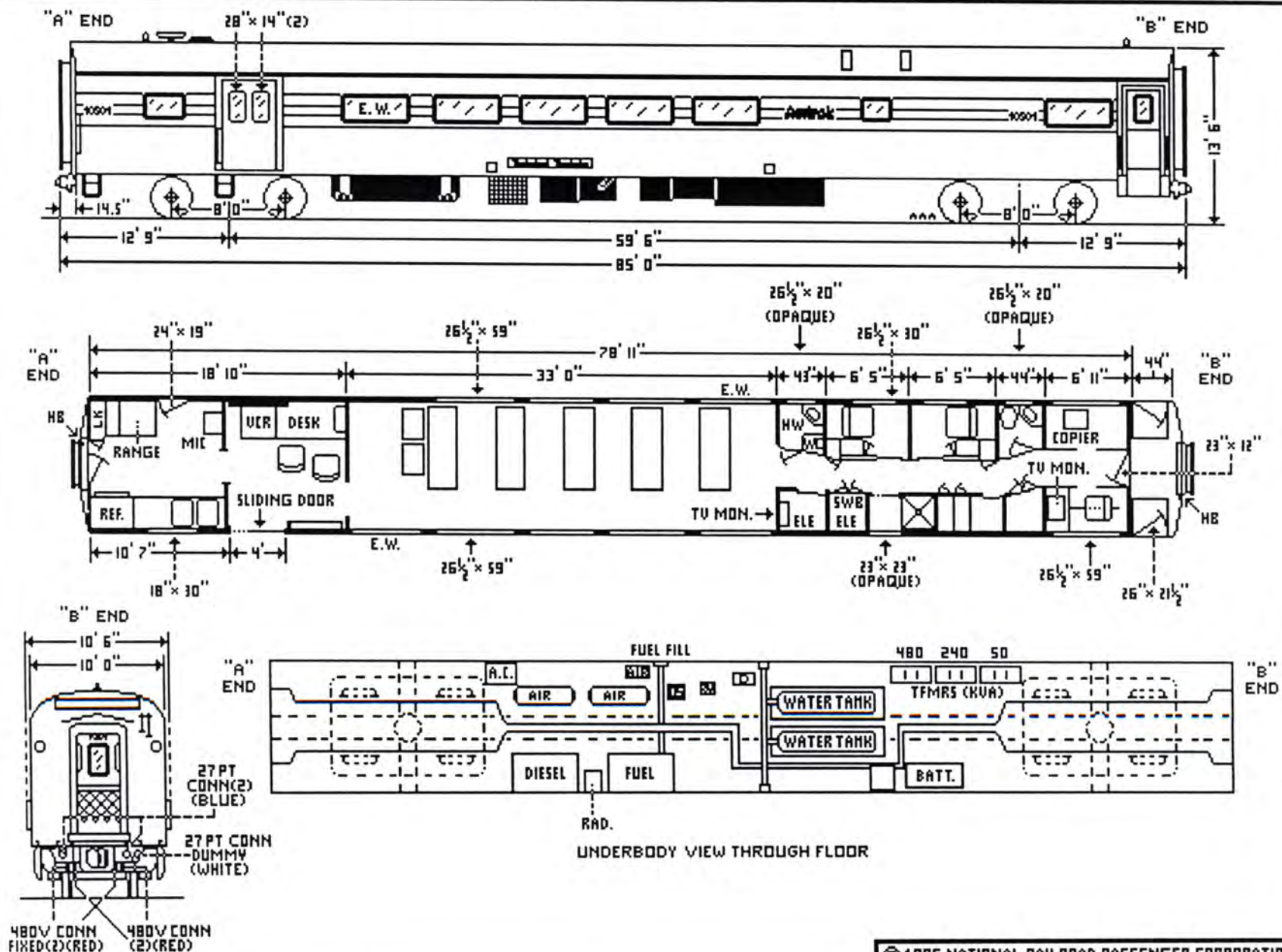

TRAINING CAR 10502

Equipment Code: TR

103 MPH

Car Number : 10502

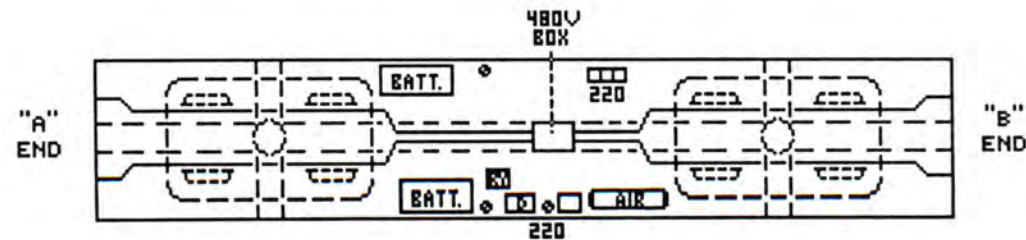
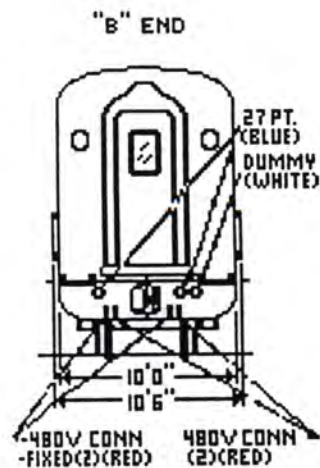
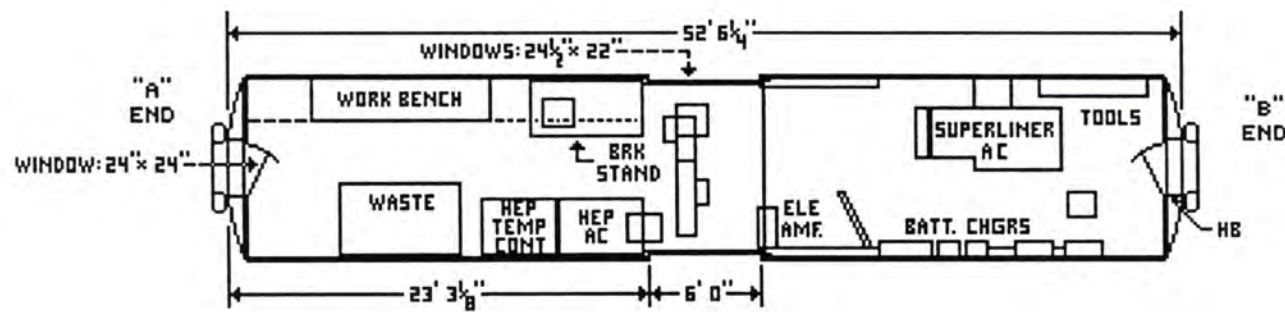
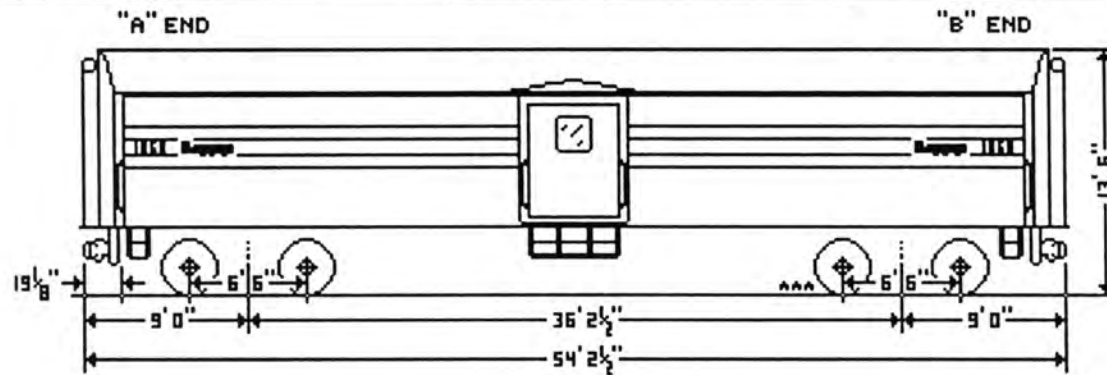

UNDERBODY VIEW THROUGH FLOOR

TRAINING CAR 10504

Equipment Code: TR

110 MPH

Car Number : 10504

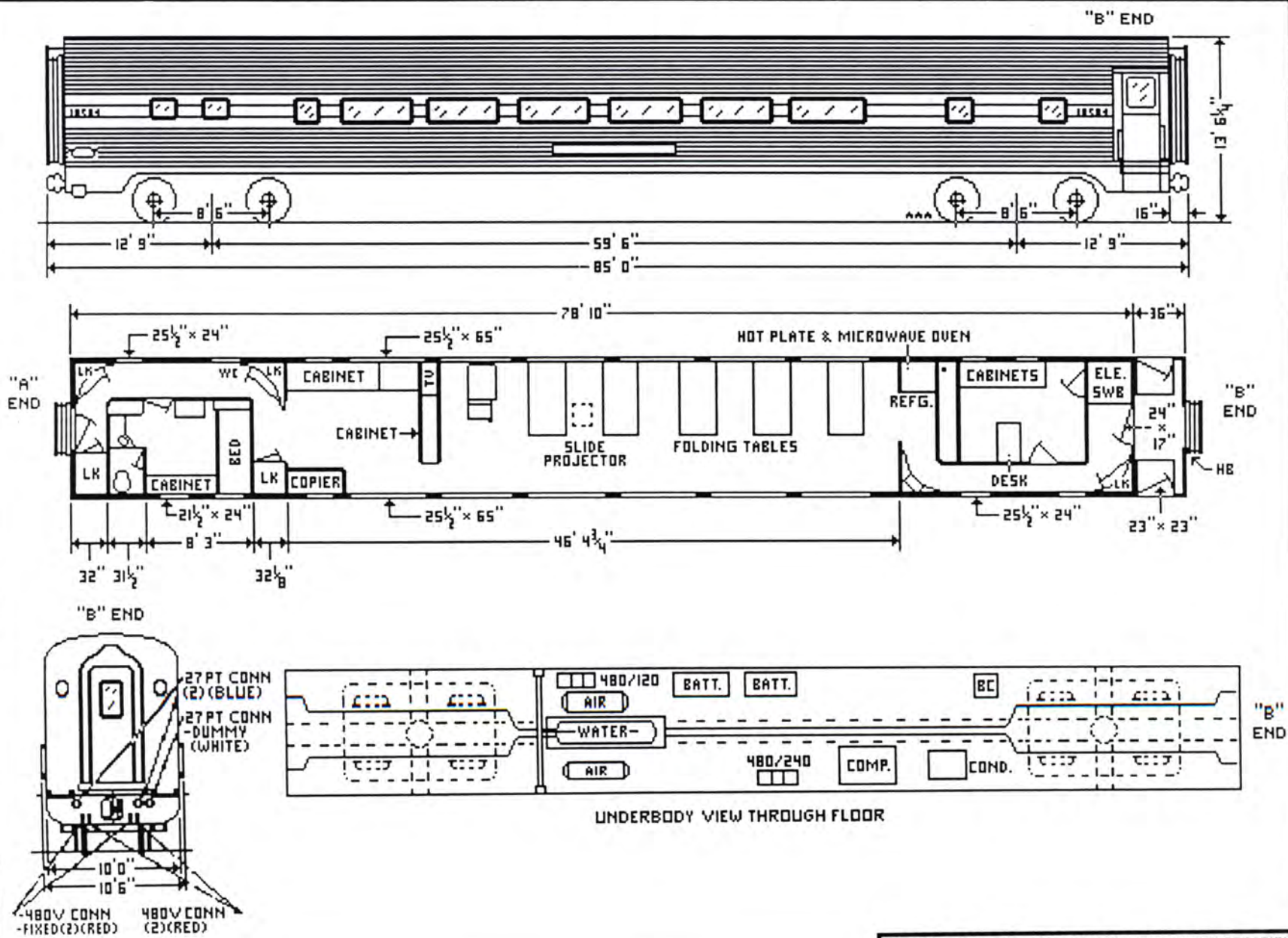

TRAINING CAR 10505

Equipment Code: TR

110 MPH

Car Number : 10505

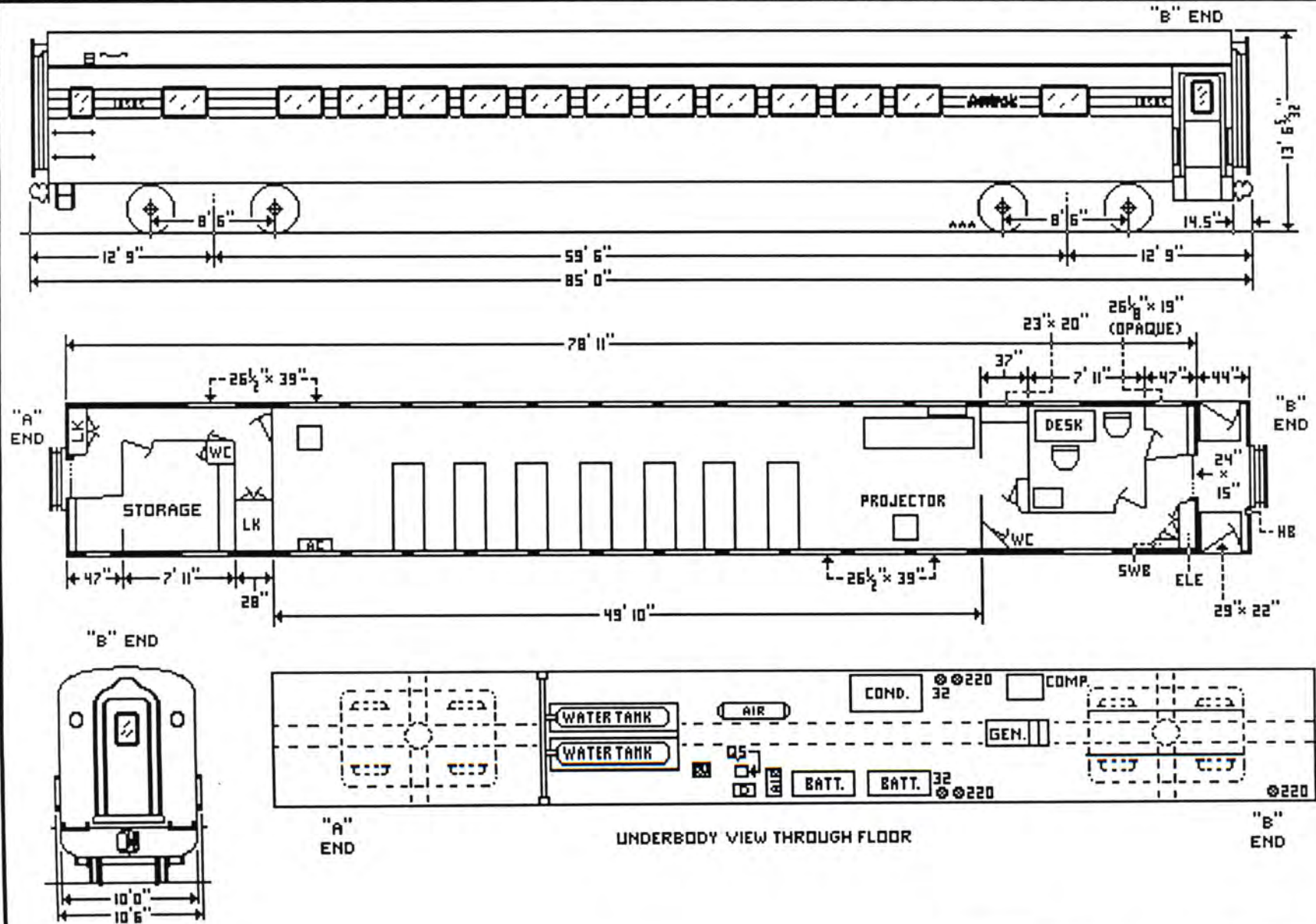

AMFLEET-I CAFE

Equipment Code: AF

125 MPH

Car Numbers: 20000-20053

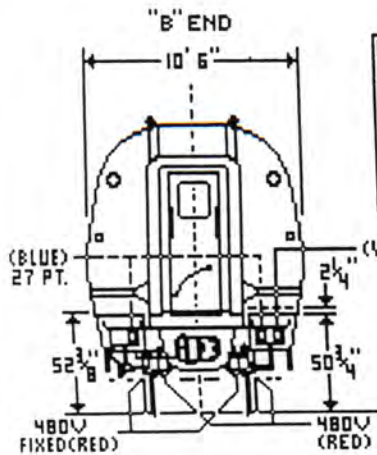
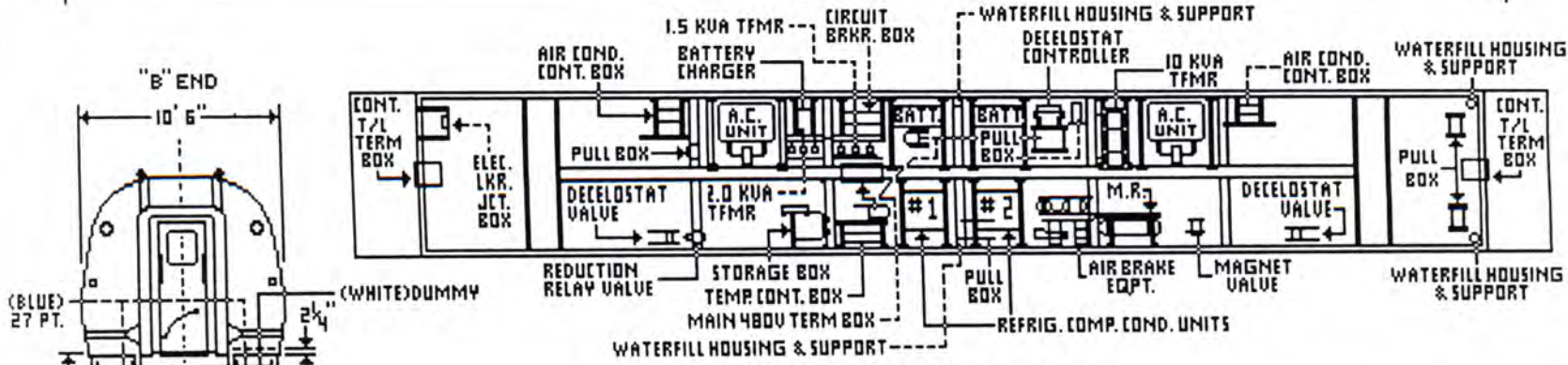
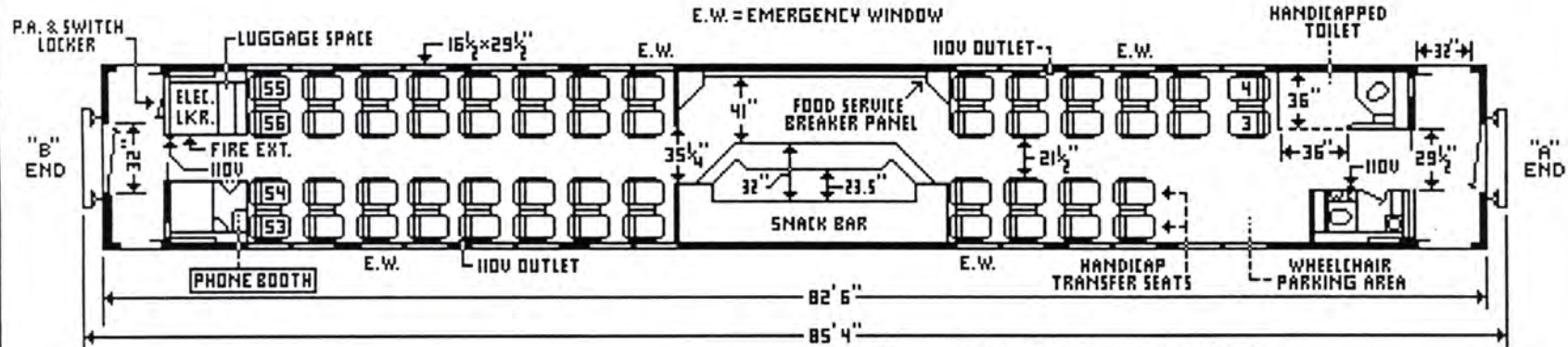
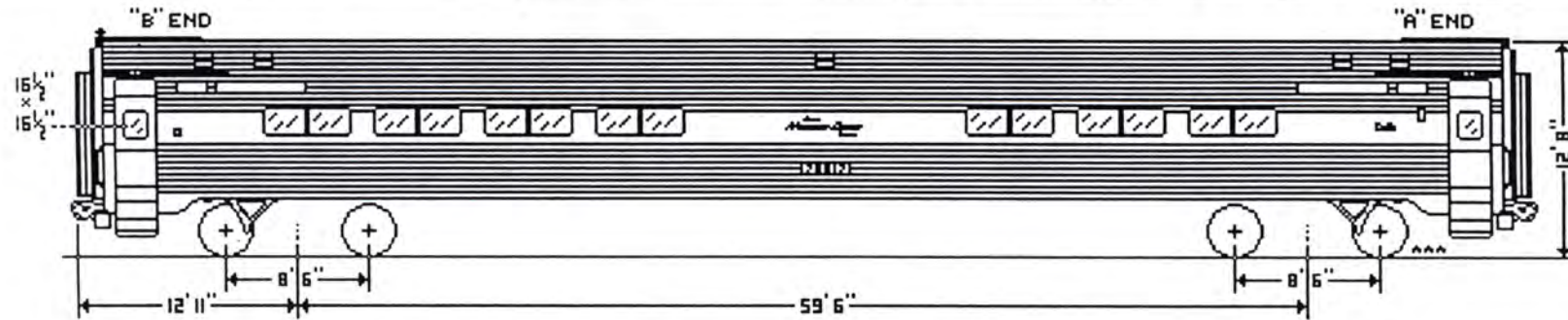

UNDERBODY VIEW THROUGH FLOOR
* INCLUDES A.D.A. MODIFICATIONS *

SEATS: 52

AMFLEET-I SPLIT CLUB

Eqpt. Code: AC

125 MPH

Car Nos : 20123-20145

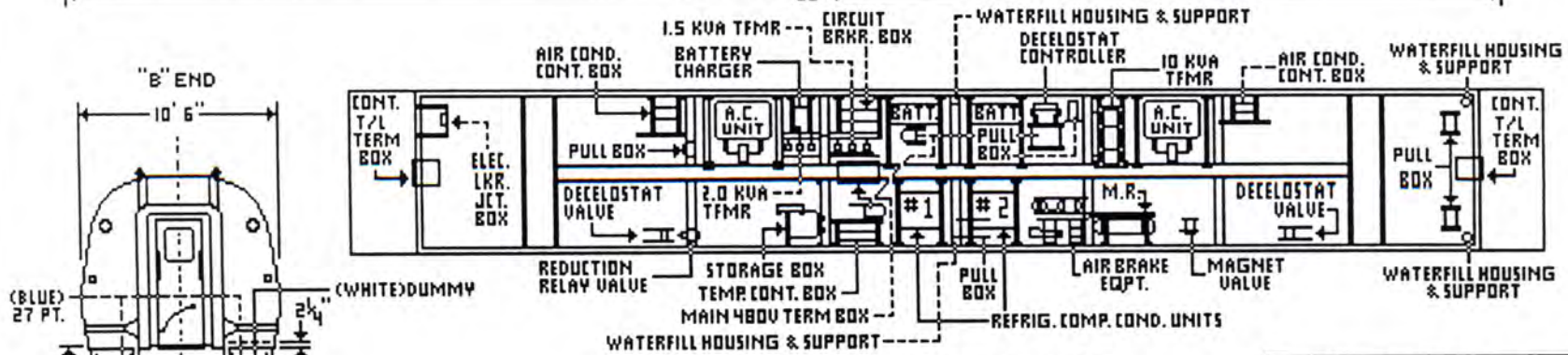
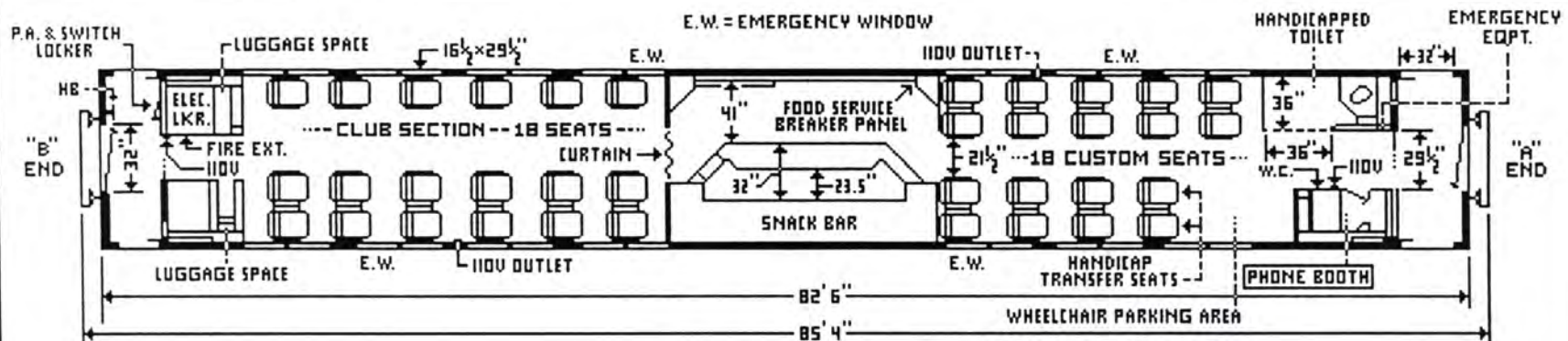
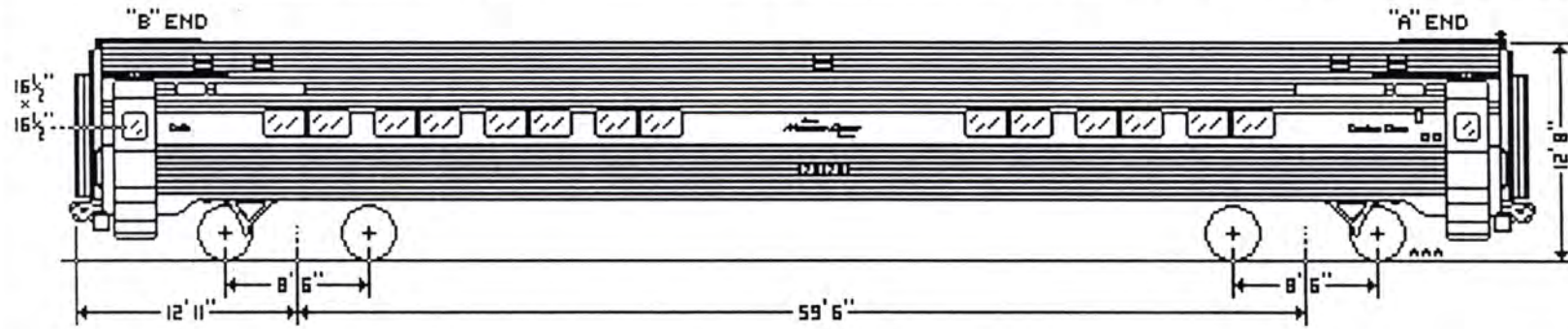

UNDERBODY VIEW THROUGH FLOOR

INCLUDES A.D.A. MODIFICATIONS

CUSTOM SEATS: 18
CLUB SEATS: 18

AMFLEET-I DINETTE

Equipment Code: AD

125 MPH

Car Numbers: 20217-20242

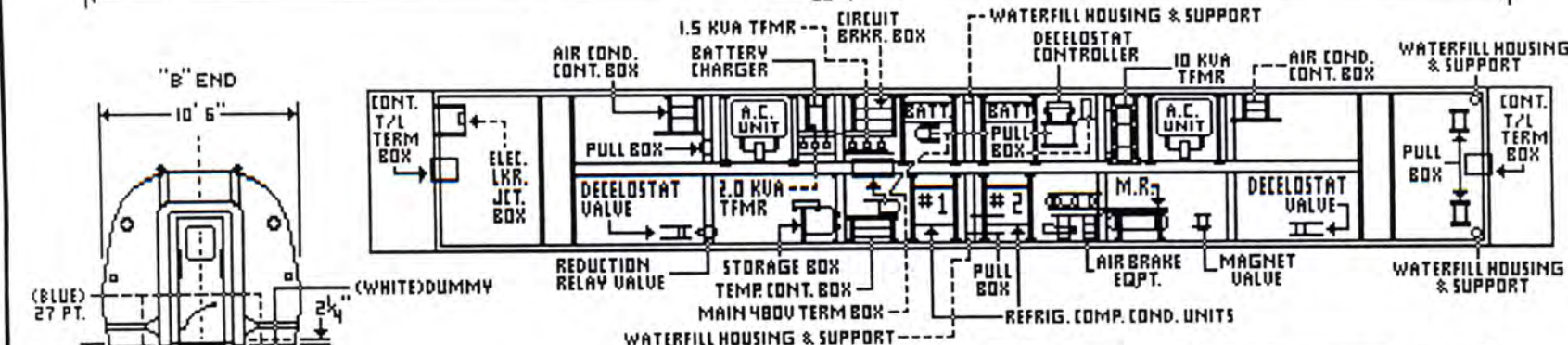
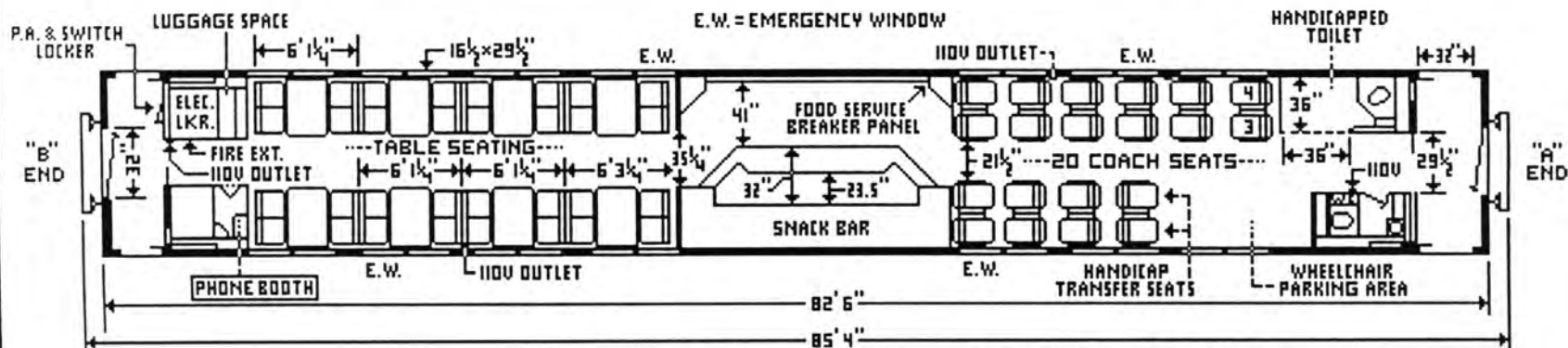
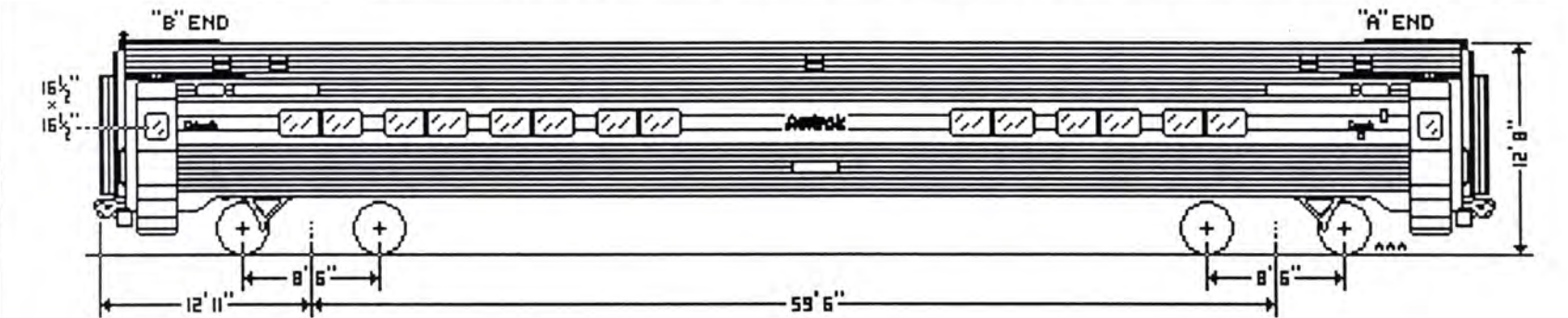

TABLE SEATS: 32
COACH SEATS: 20

* INCLUDES A.D.A. MODIFICATIONS *

AMFLEET-I FULL CLUB

Equipment Code: AP

125 MPH

Car Numbers: 20979,20982

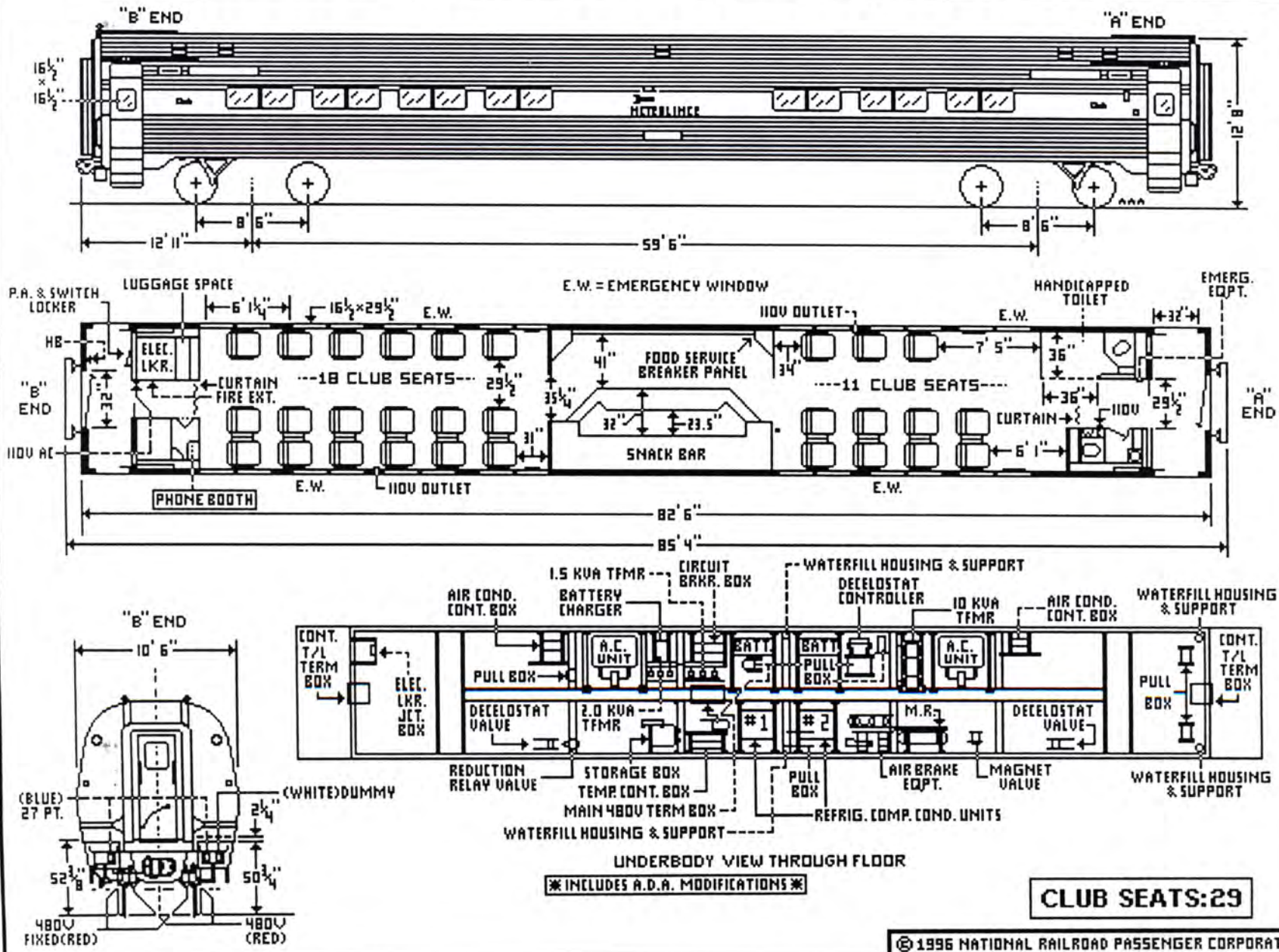

AMFLEET-I COACH

Equipment Code: A0

125 MPH

Car Numbers: 21000-21285

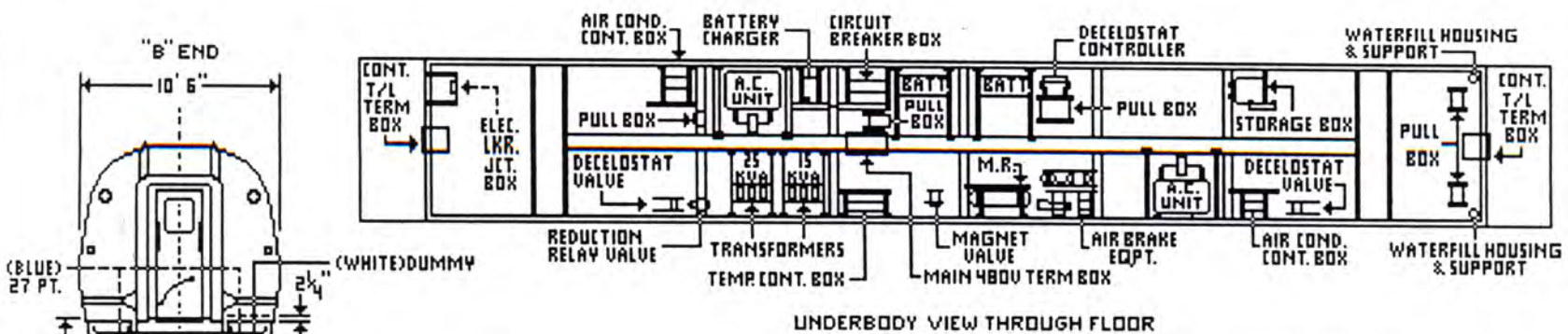
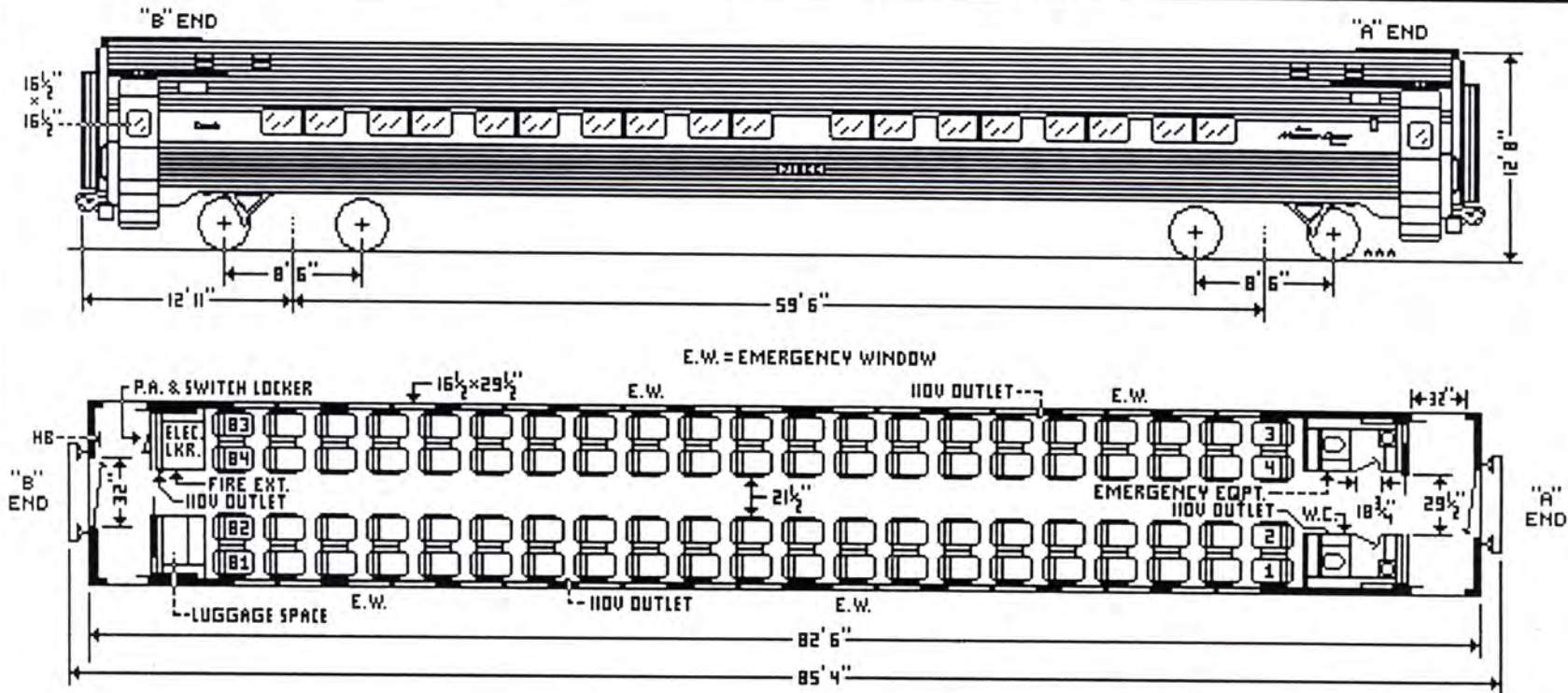

SEATS: 84

AMFLEET-I COACH (HANDICAPPED)

Equipment Code: A0

125 MPH

Car Nos: 21600-21699

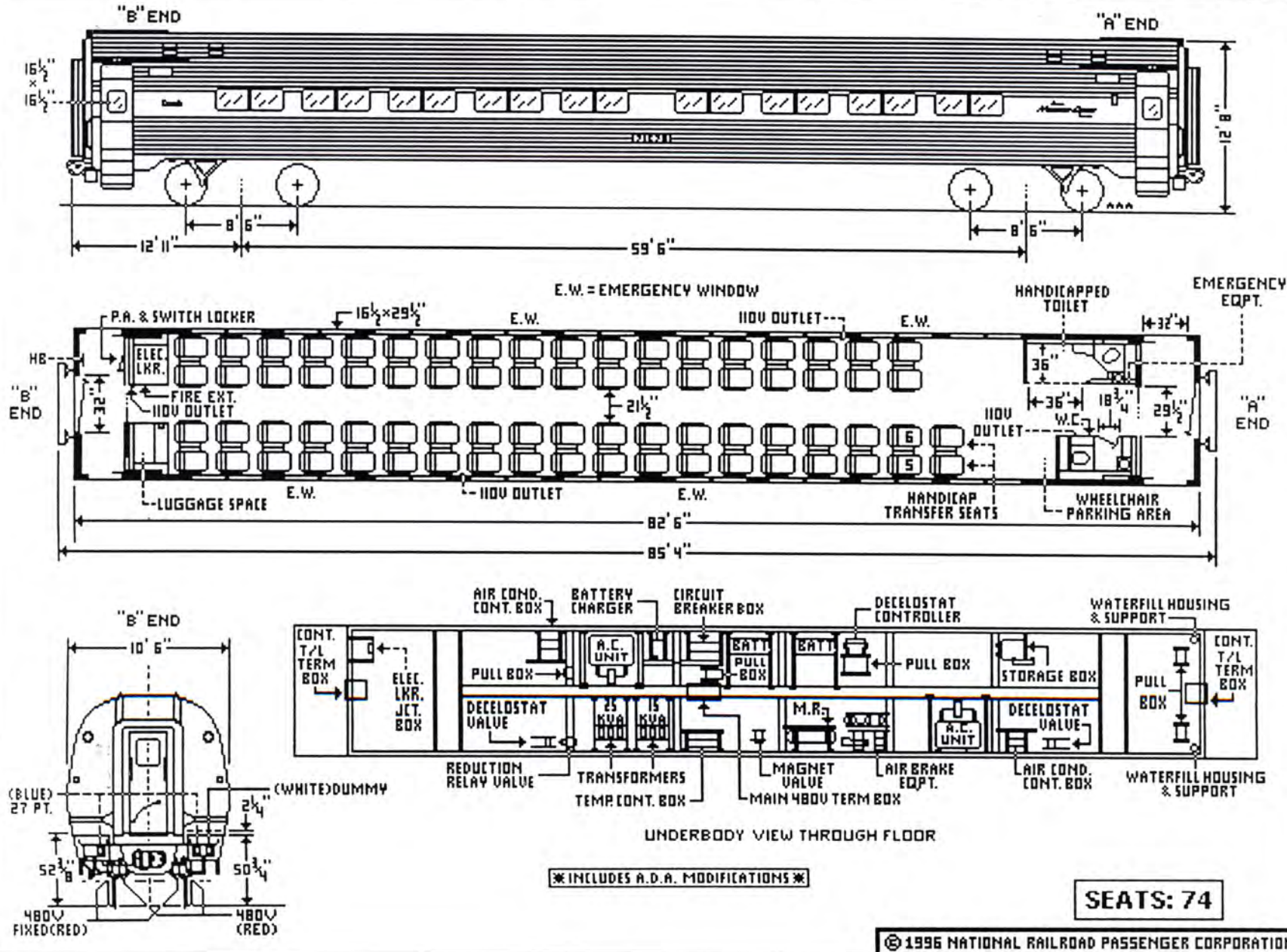

METROLINER AMFLEET COACH (HANDICAPPED)

Eqpt. Code: MC

125 MPH

Car Nos: 21700-21788

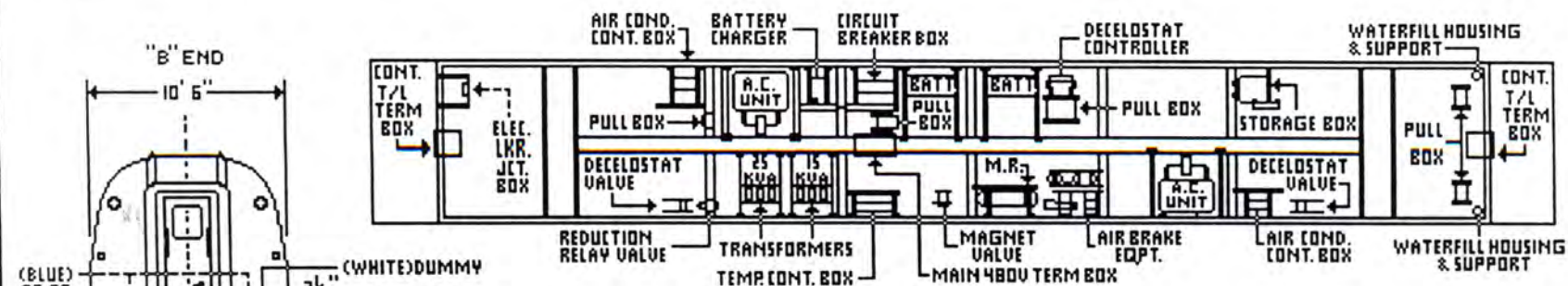
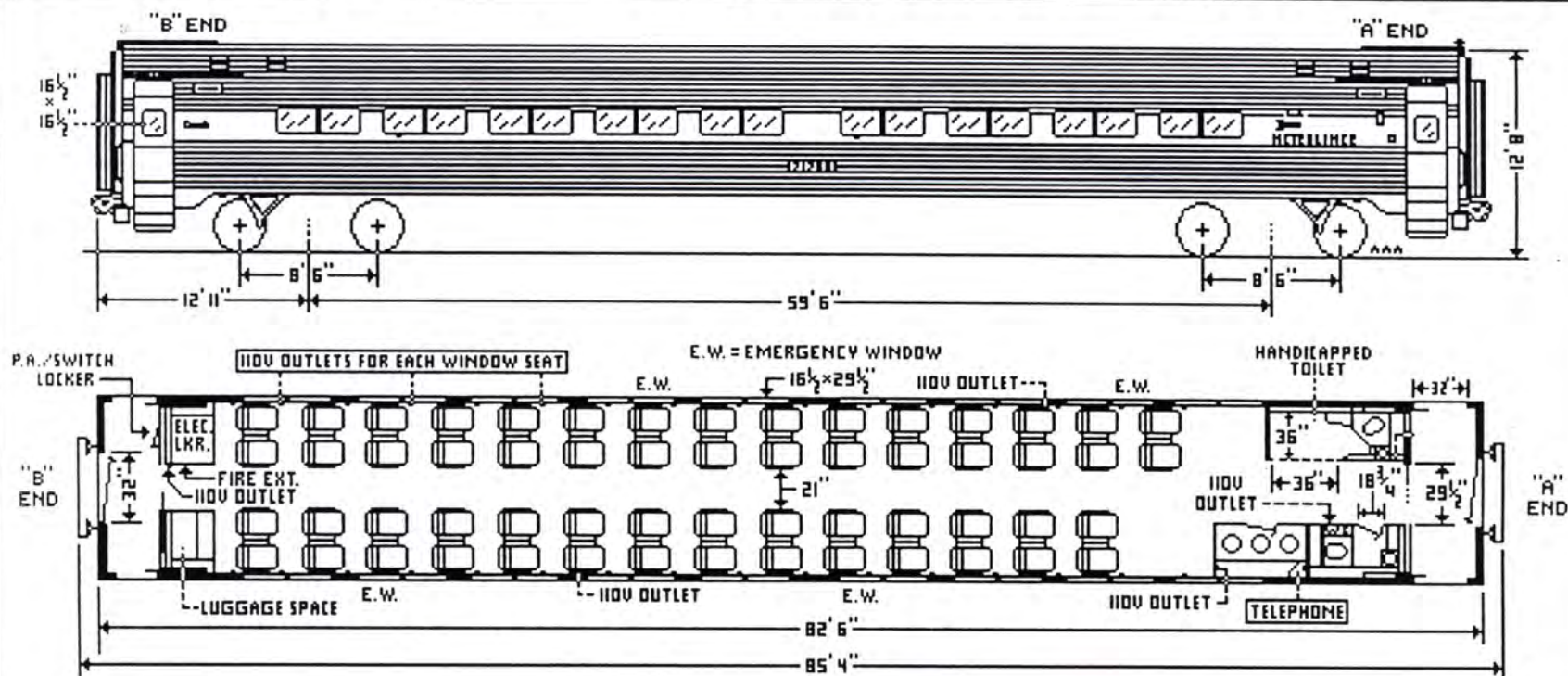

UNDERBODY VIEW THROUGH FLOOR

* INCLUDES A.D.A. MODIFICATIONS *

SEATS: 58

METROLINER AMFLEET COACH (HDCP)

Eqpt. Code: MC

125 MPH

Car Nos: 21705, 08, 10, 12

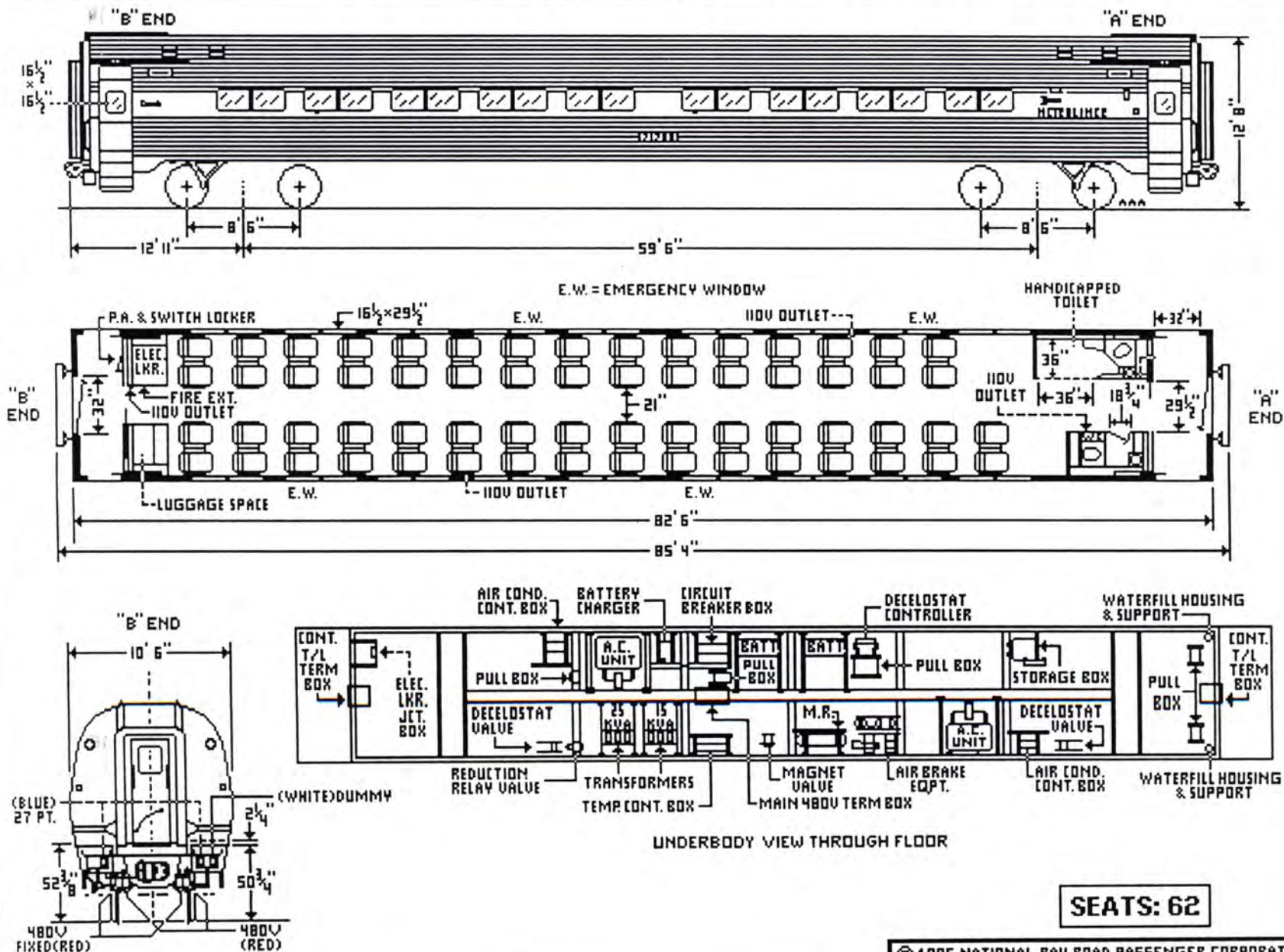

SEATS: 62

METROLINER AMFLEET COACH

Eqpt. Code: MC

125 MPH

Car Numbers: 21908, 21989

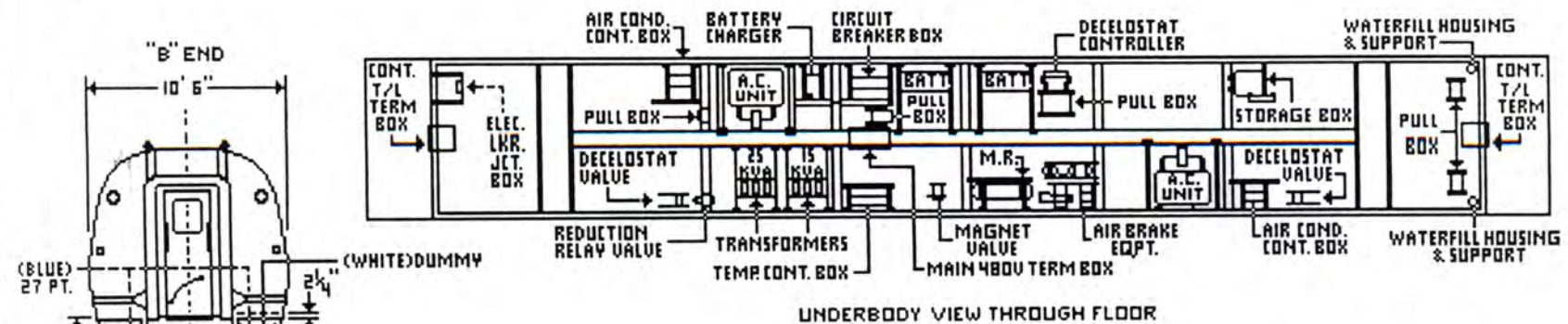
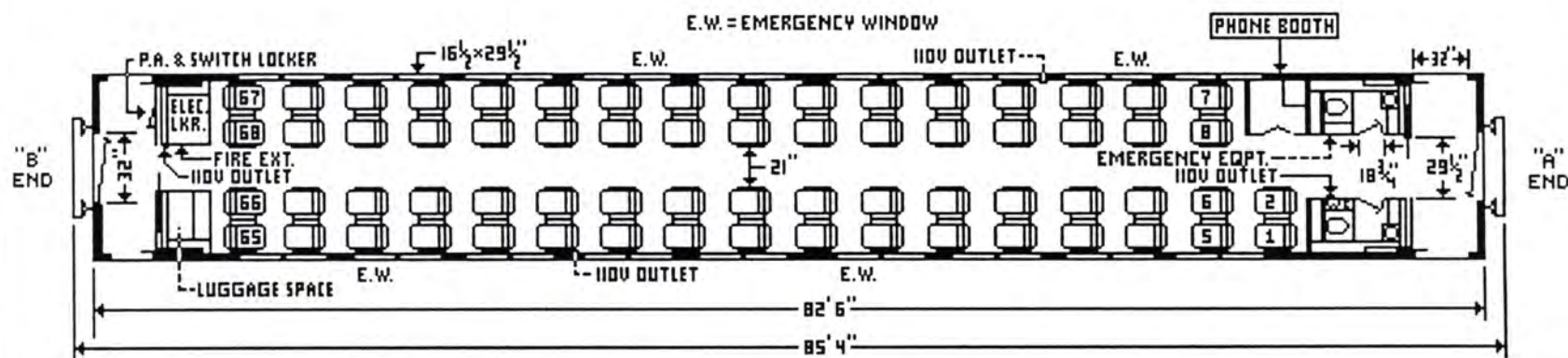
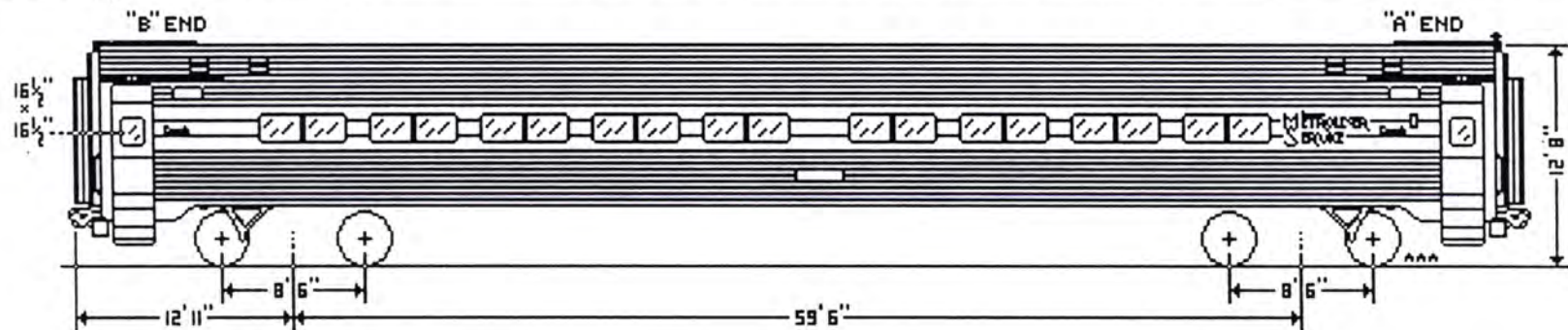

SEATS: 66

AMFLEET-I CUSTOM CLASS COACH(HDCP)

Eqpt. Code: MN

125 MPH

Car Nos: 21926

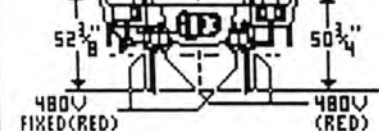
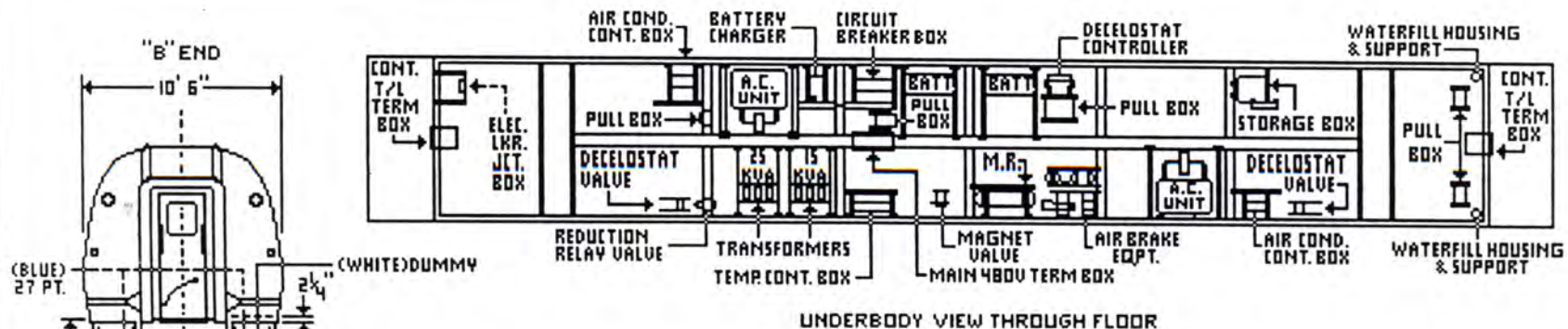
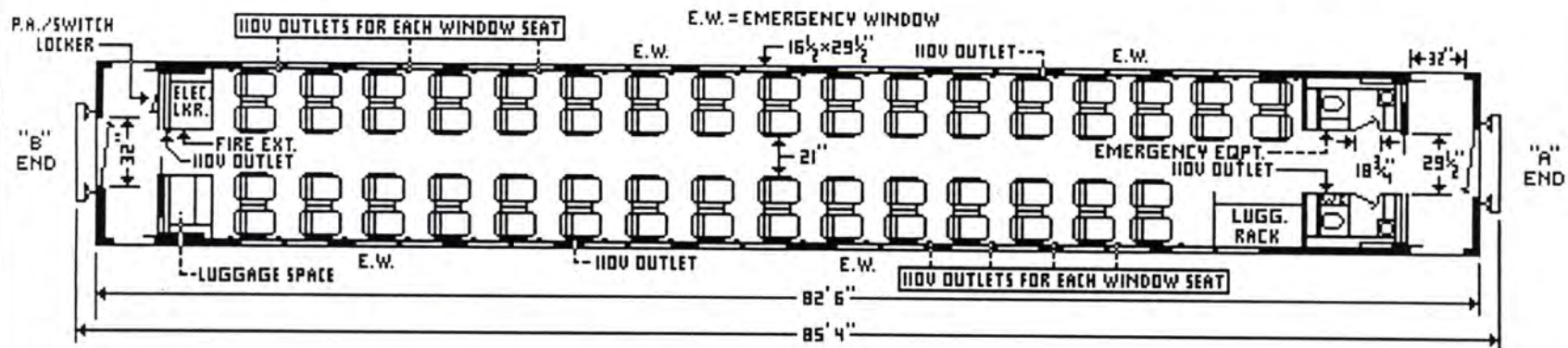
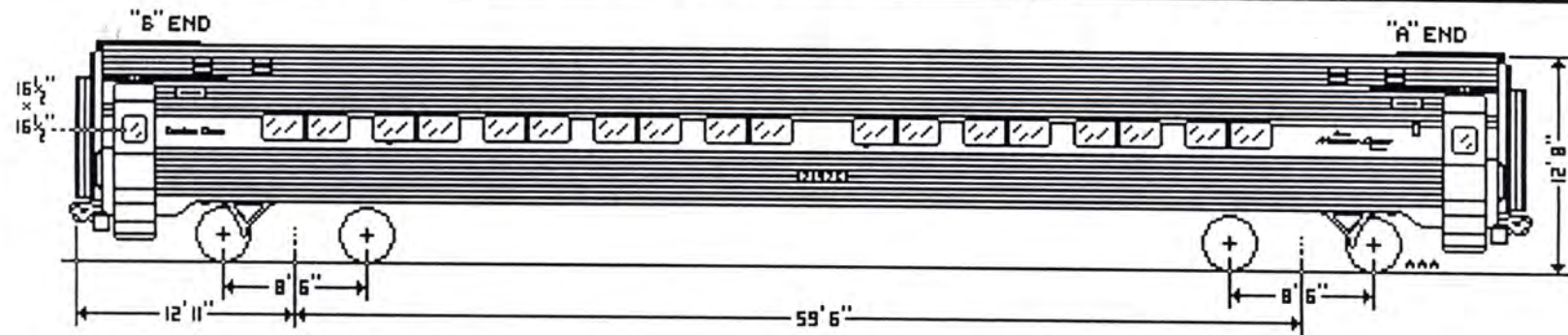

SEATS: 64

AMFLEET-II COACH

Equipment Code: AI

125 MPH

Car Numbers: 25000-25124

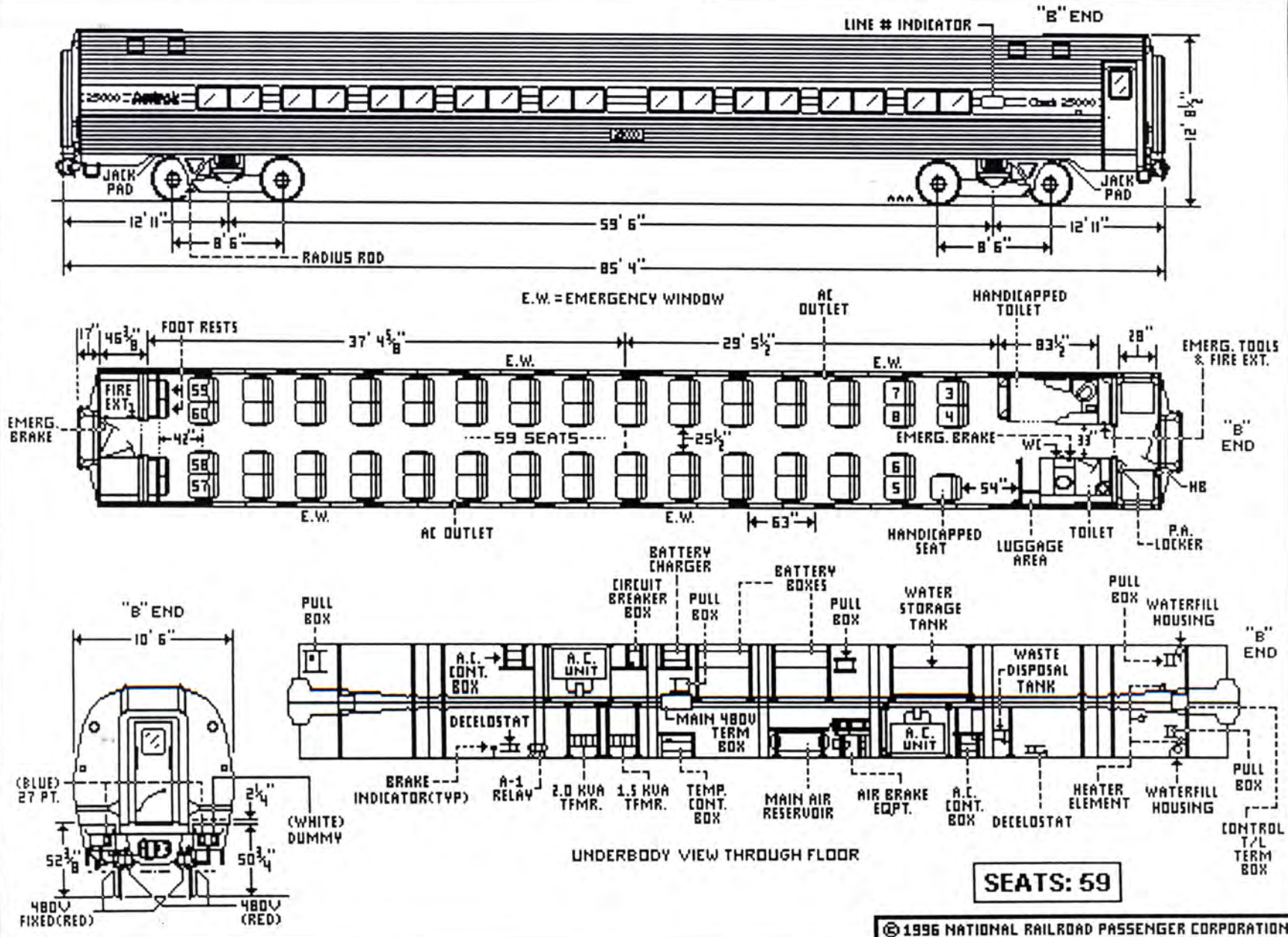

SEATS: 59

AMFLEET-II LOUNGE CAR

Equipment Code: AH

125 MPH

Car Numbers: 28000-28024

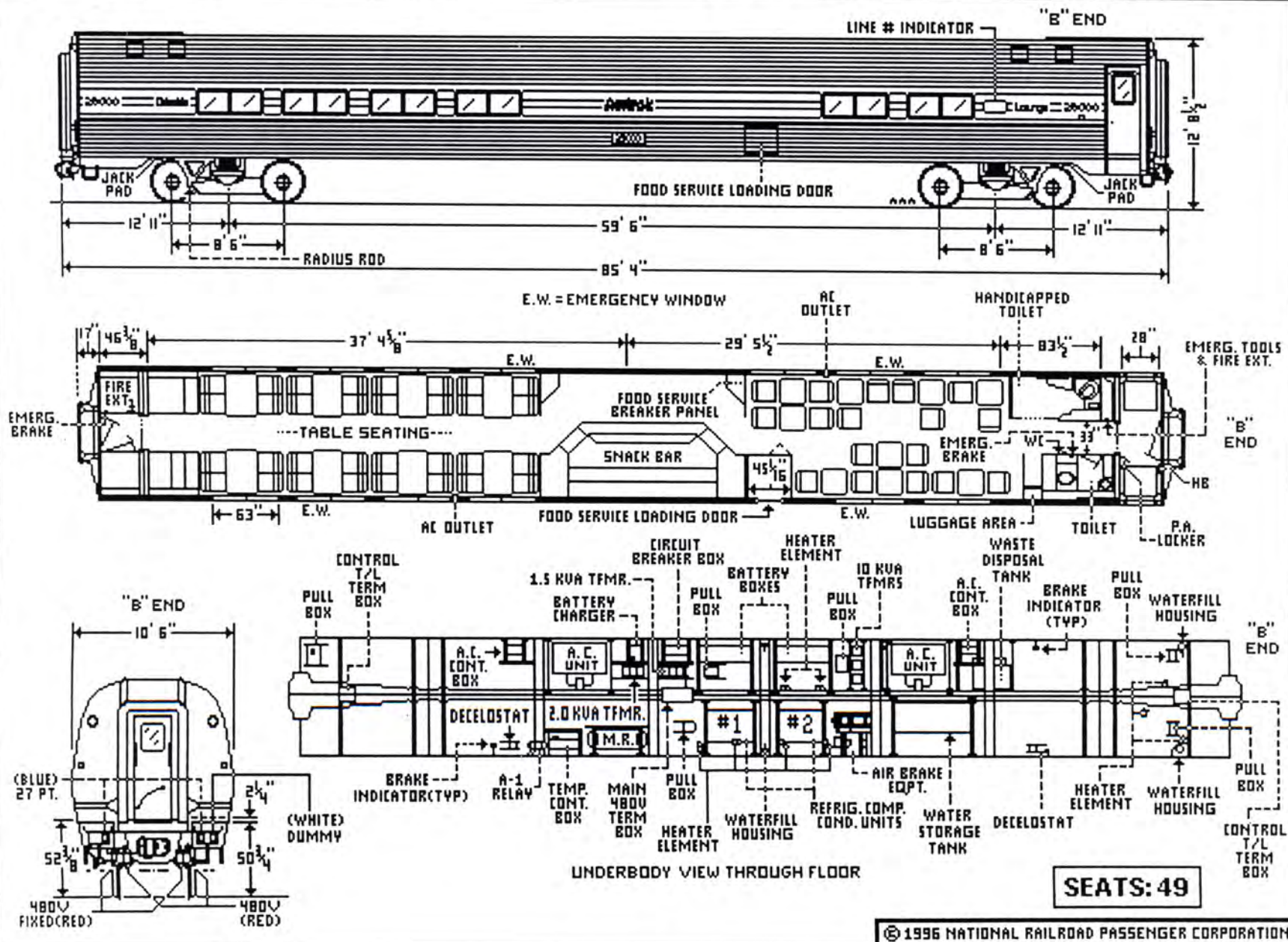

AMFLEET-I METROLINER LOUNGE-GRILL

Equipment Code: MF

125 MPH

Car Number :28303

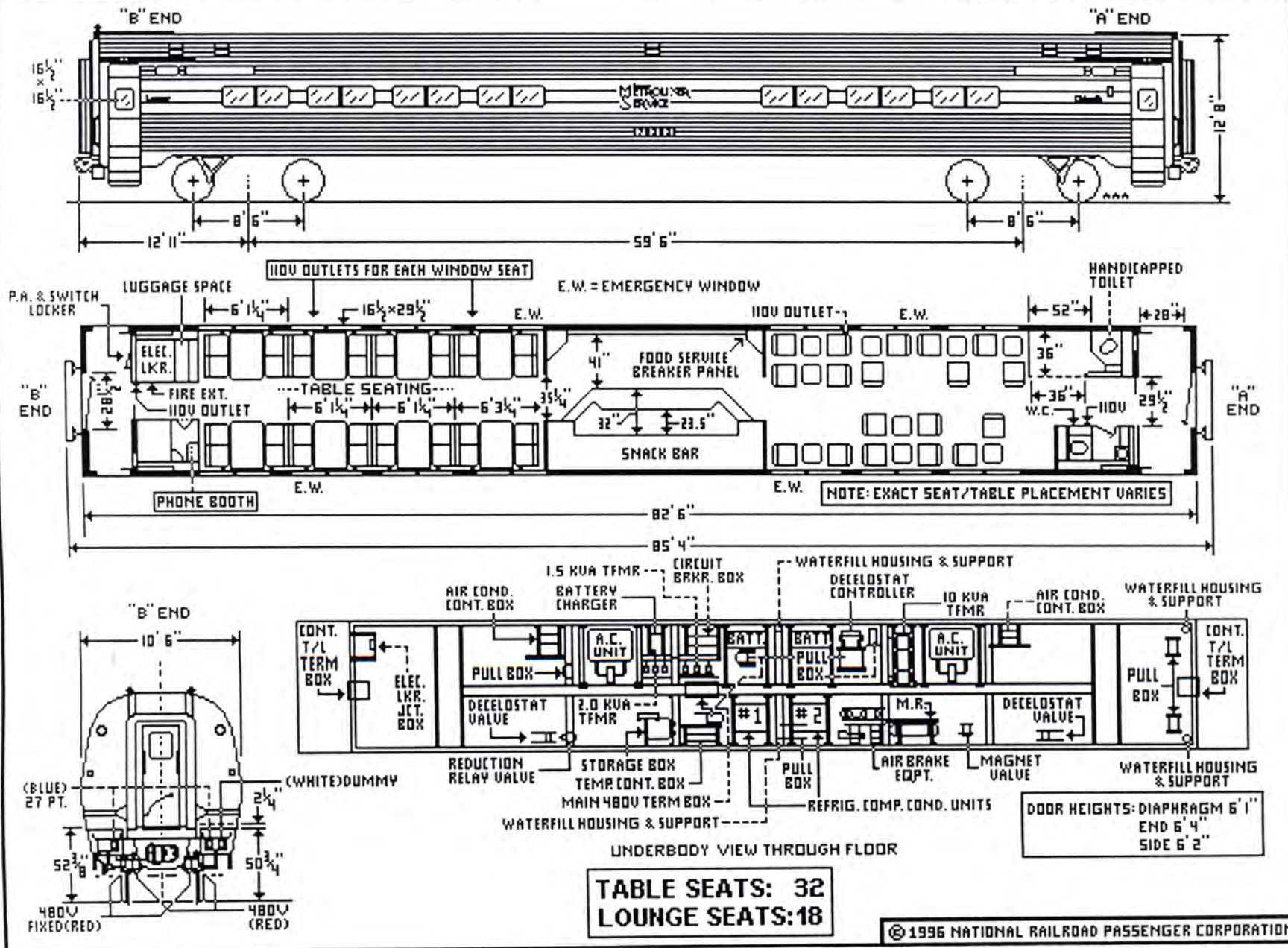

ALL-TABLE METROLINER DINETTE

Equipment Code: MF

125 MPH

Car Nos: 28350-28355

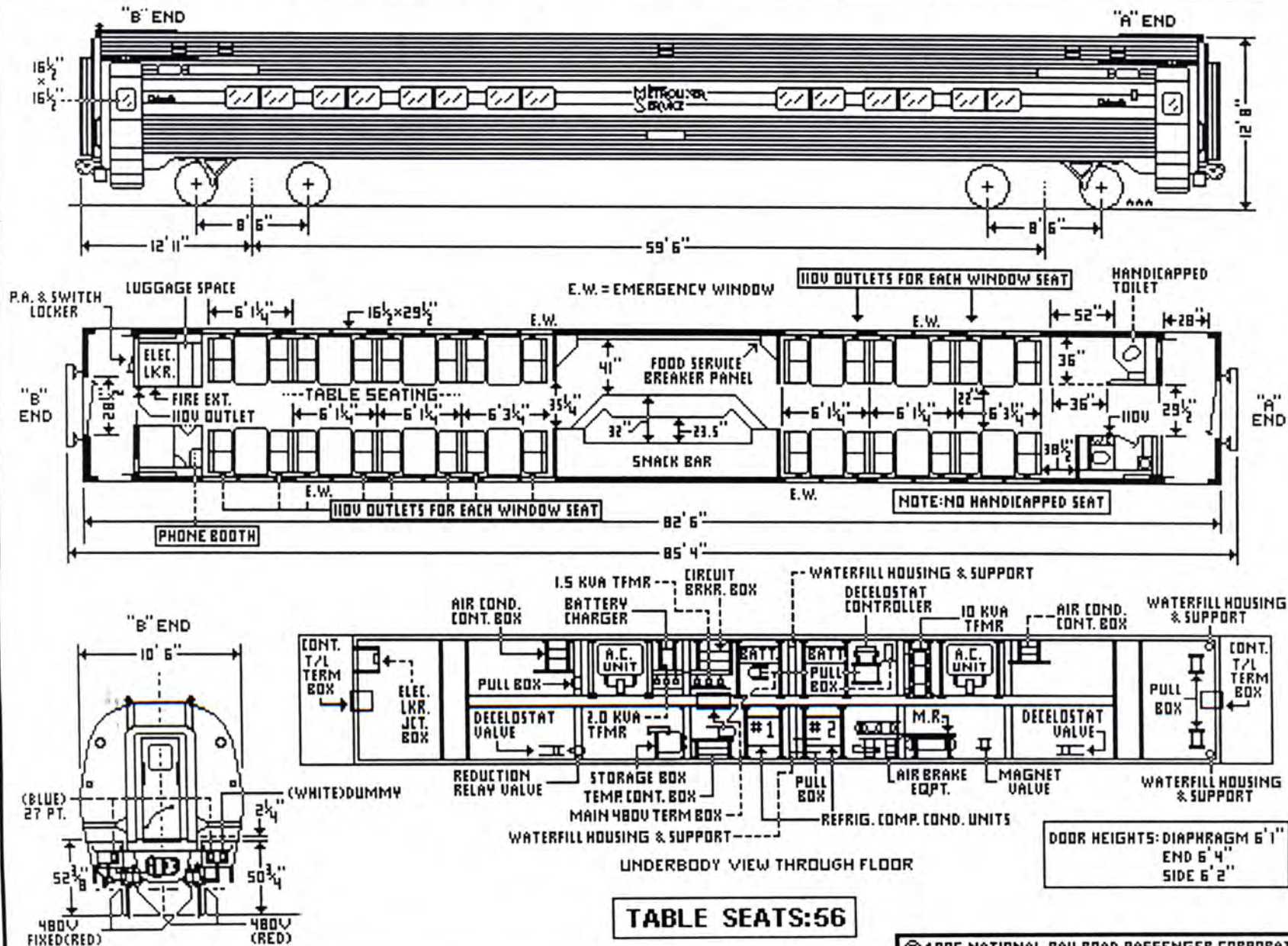

AMFLEET-I DELUXE LOUNGE

Equipment Code: AL

125 MPH

Car Nos: 28390-28394

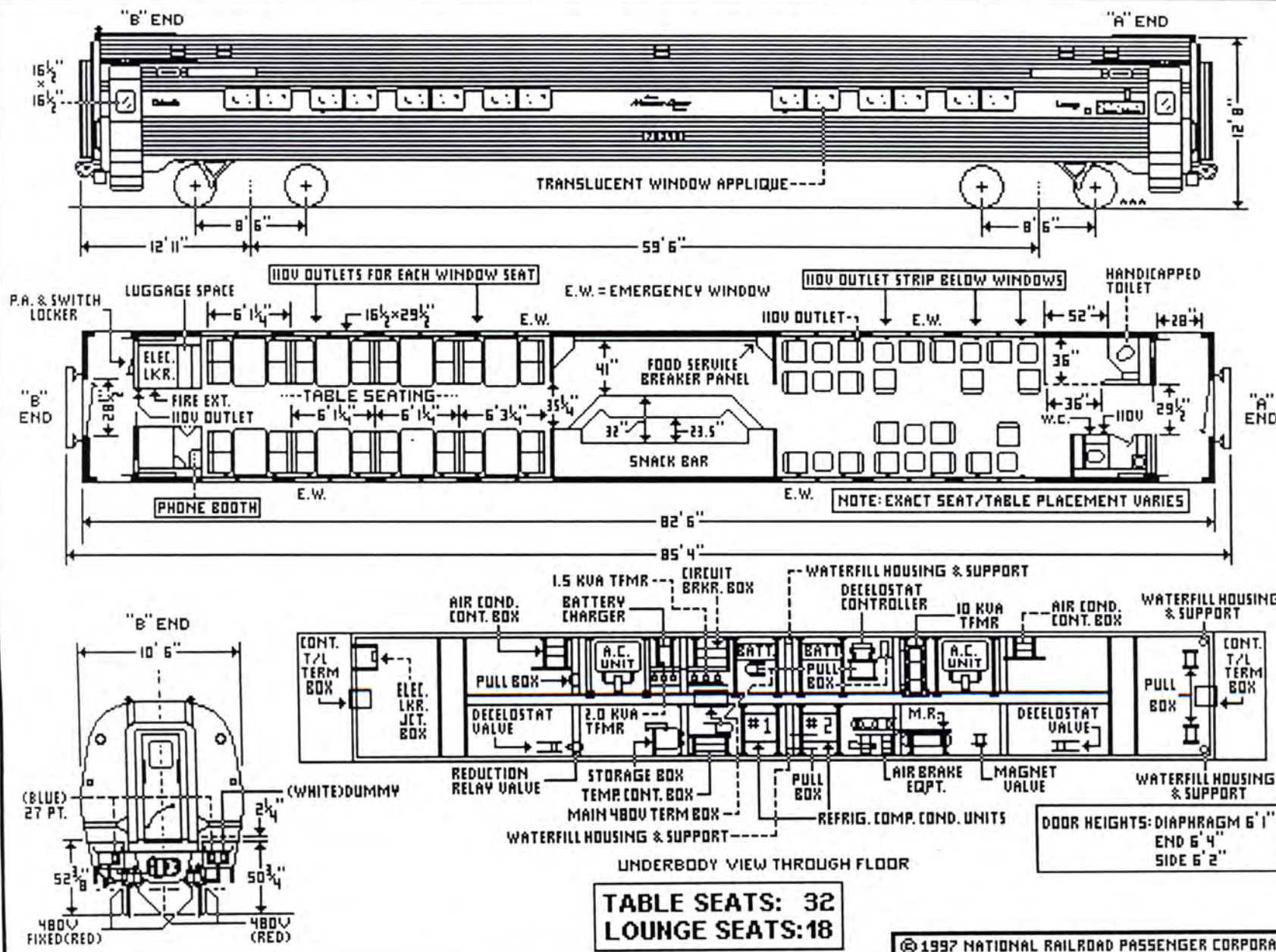

SUPERLINER BAGGAGE-COACH

Equipment Code: SQ

100 MPH

Car Nos: 31000-31047

LEFT SIDE VIEW

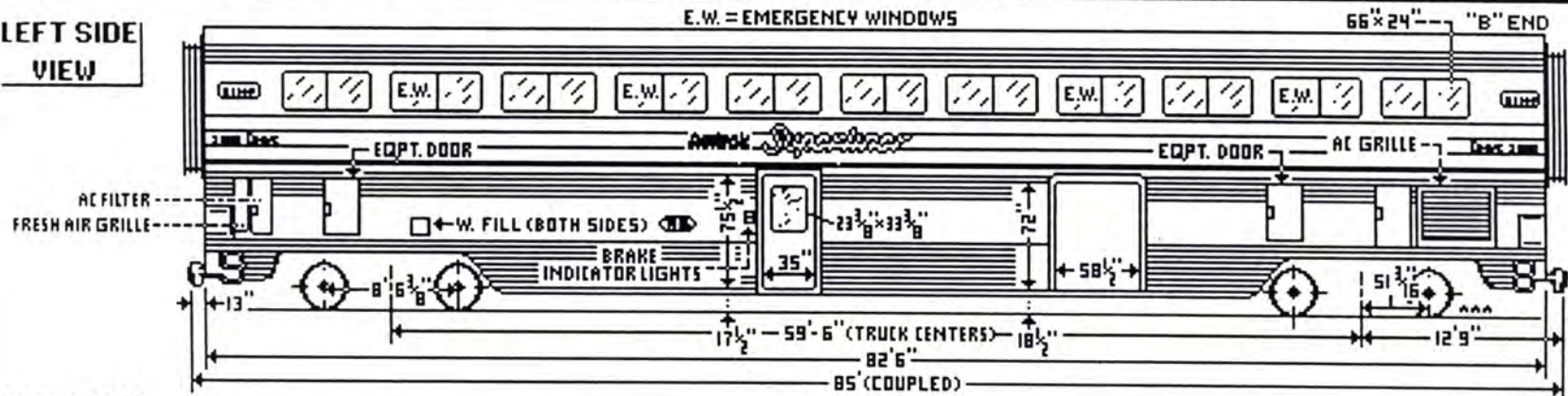

UPPER LEVEL

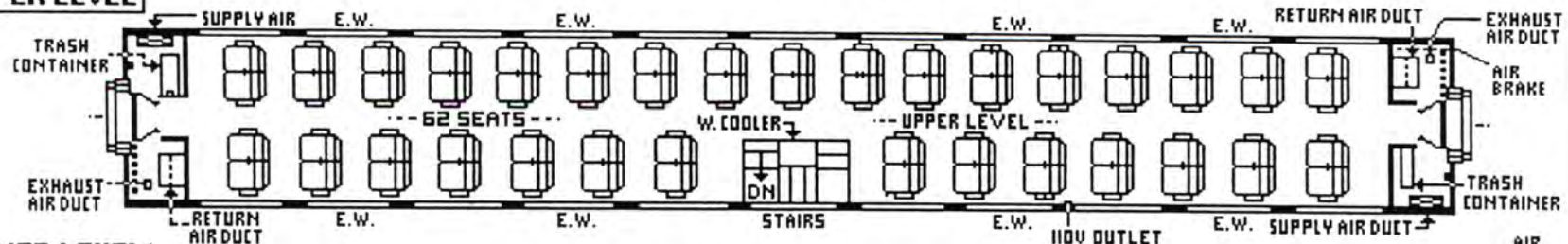

LOWER LEVEL

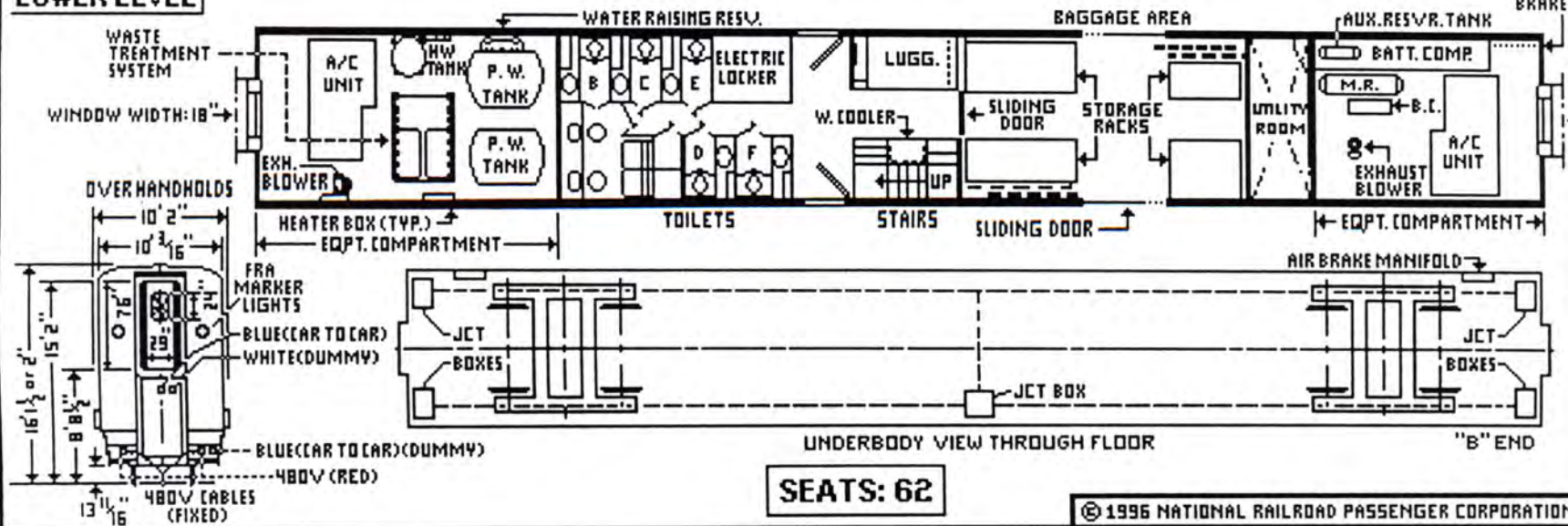

SUPERLINER SMOKING COACH

Equipment Code: SM

100 MPH

Car Nos: 31500-31547

LEFT SIDE VIEW

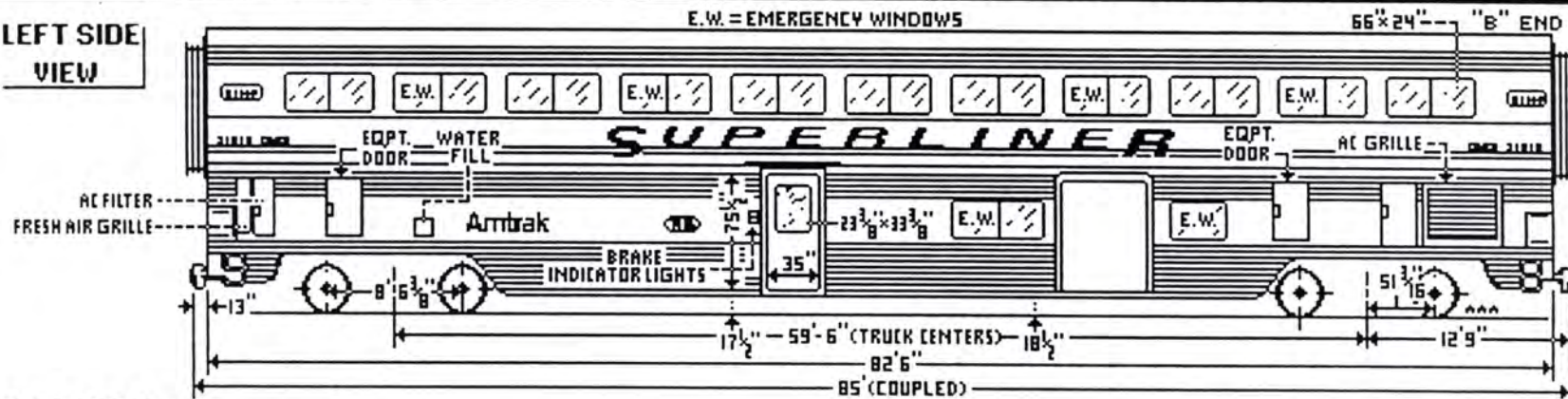

UPPER LEVEL

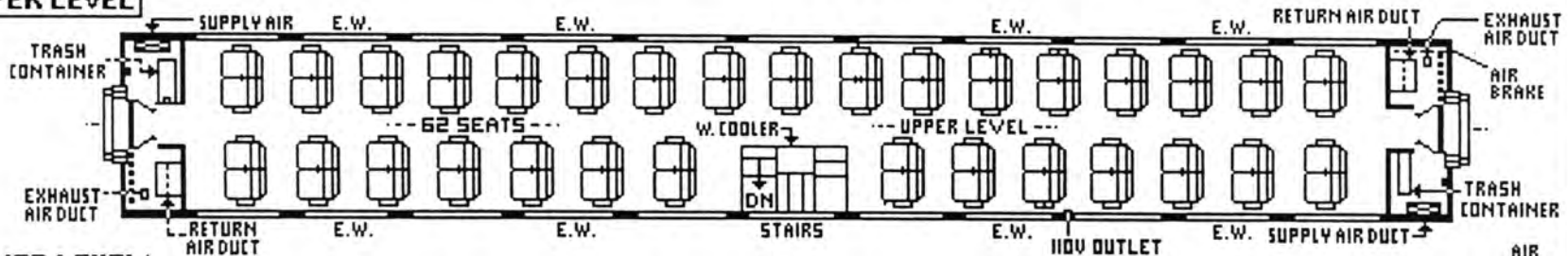

LOWER LEVEL

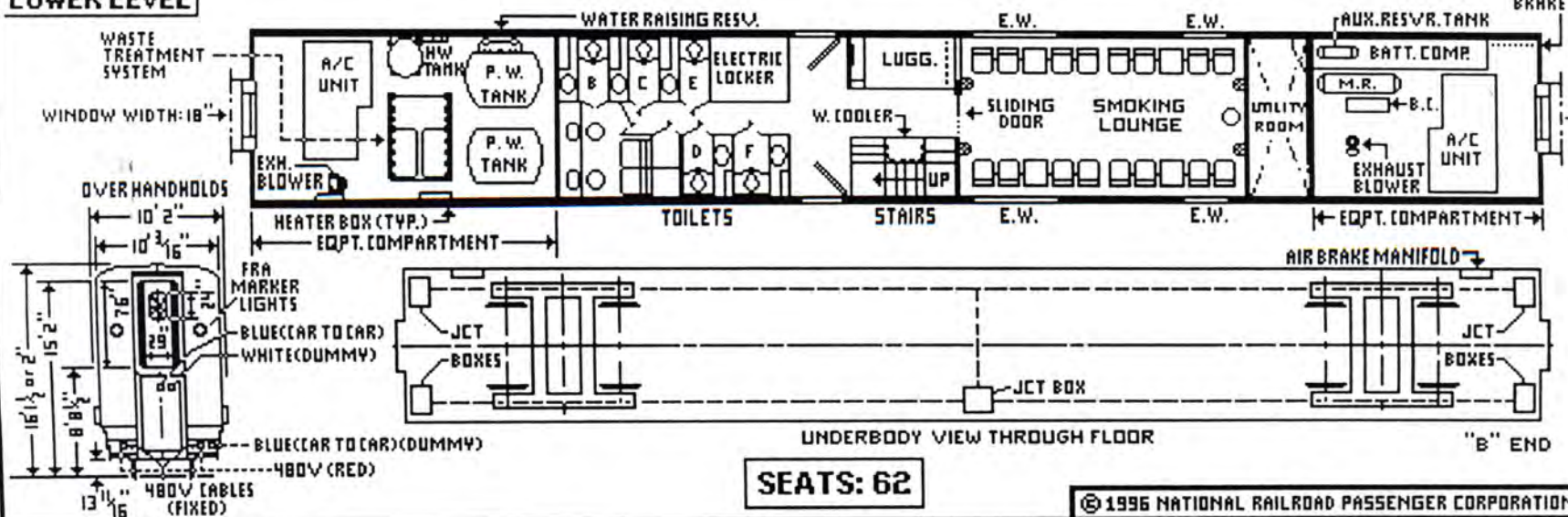

SEATS: 62

SUPERLINER SLEEPER

Equipment Code: SS

100 MPH

Car Nos: 32000-32069

LEFT SIDE VIEW

BEDROOM PAIRS "B" & "C", "D" & "E" MAY BE CONVERTED TO BEDROOM SUITES.

AC FILTER
FRESH AIR GRILLE

DELUXE BEDROOM TOILETS CONTAIN A SHOWER.

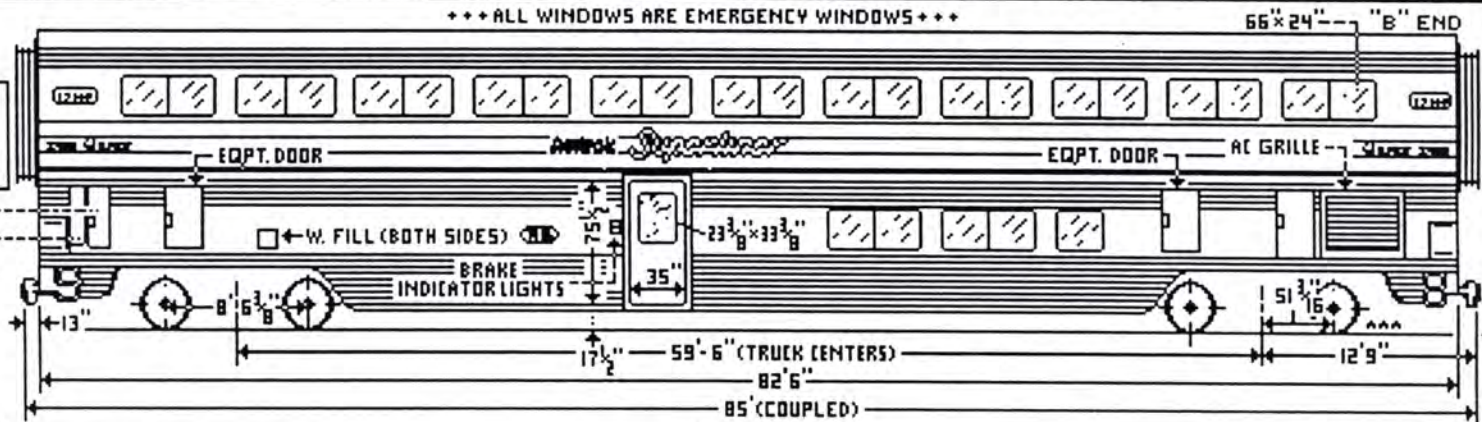

UPPER LEVEL

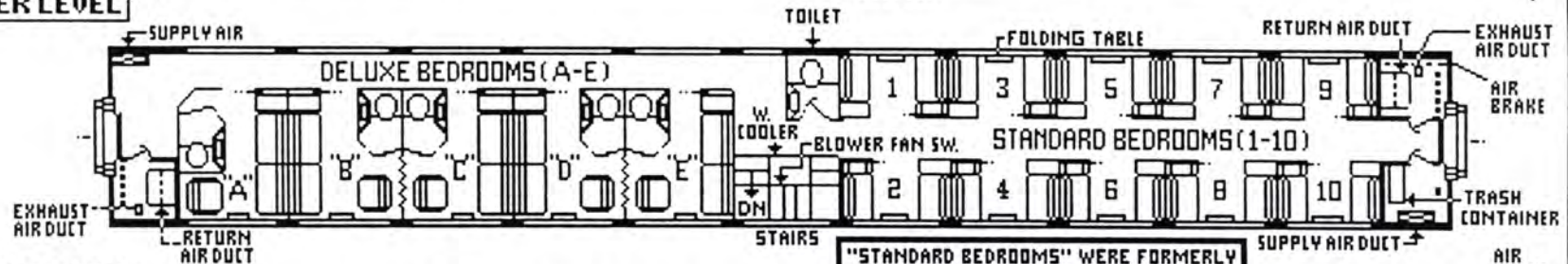

LOWER LEVEL

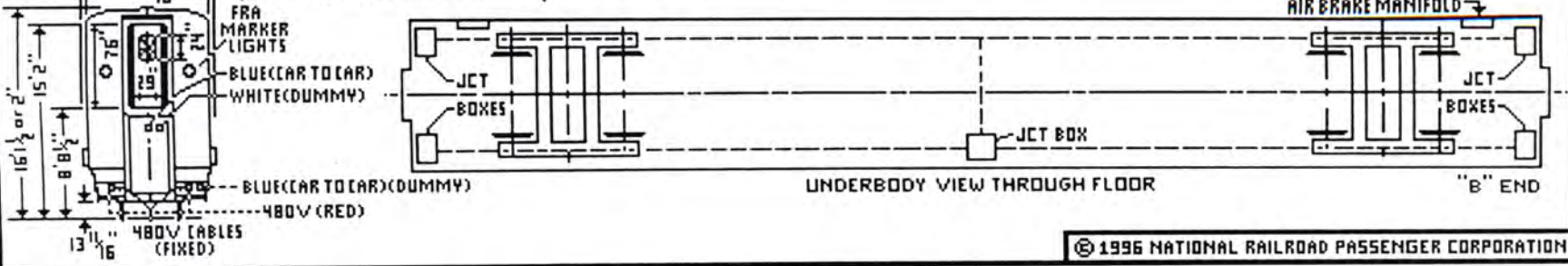
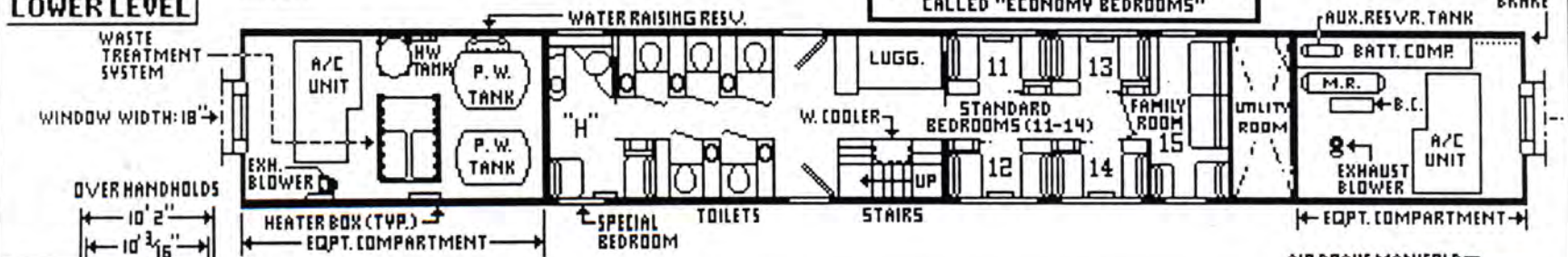

SUPERLINER II SLEEPER

Equipment Code: SS

100 MPH

Car Nos: 32070-32118

LEFT SIDE VIEW

BEDROOM PAIRS "B" & "C", "D" & "E" MAY BE CONVERTED TO BEDROOM SUITES.

DELUXE BEDROOM TOILETS CONTAIN A SHOWER.

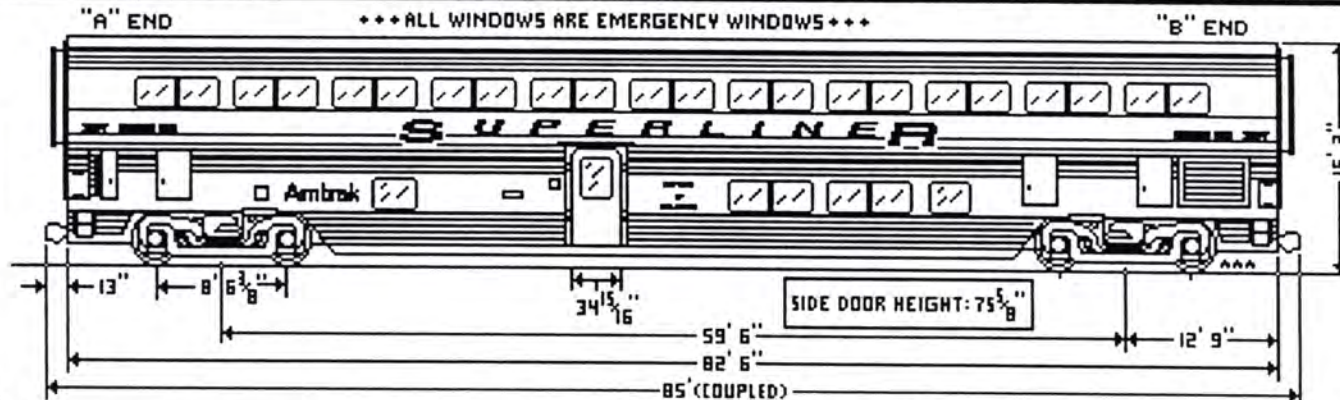

UPPER LEVEL

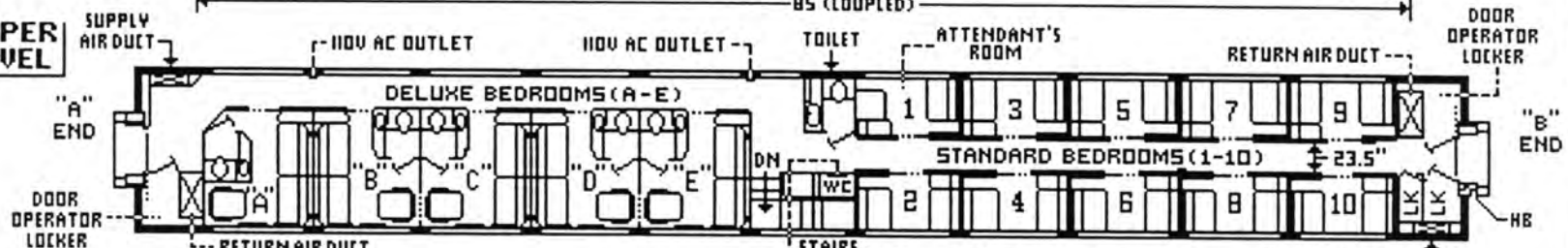

LOWER LEVEL

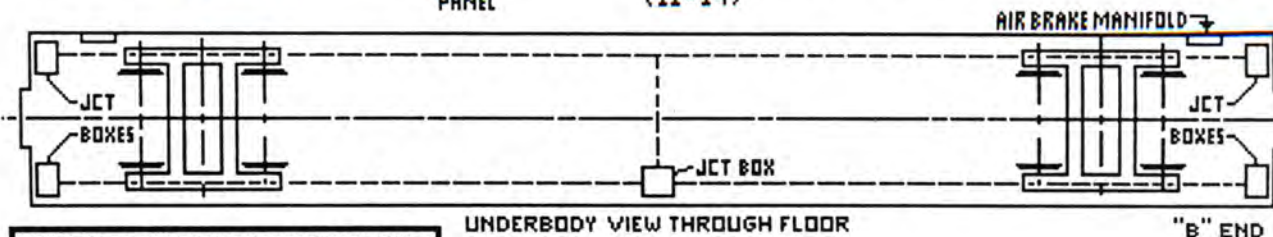
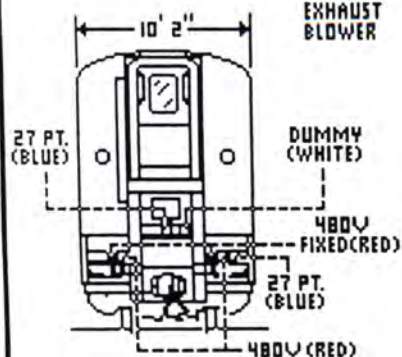
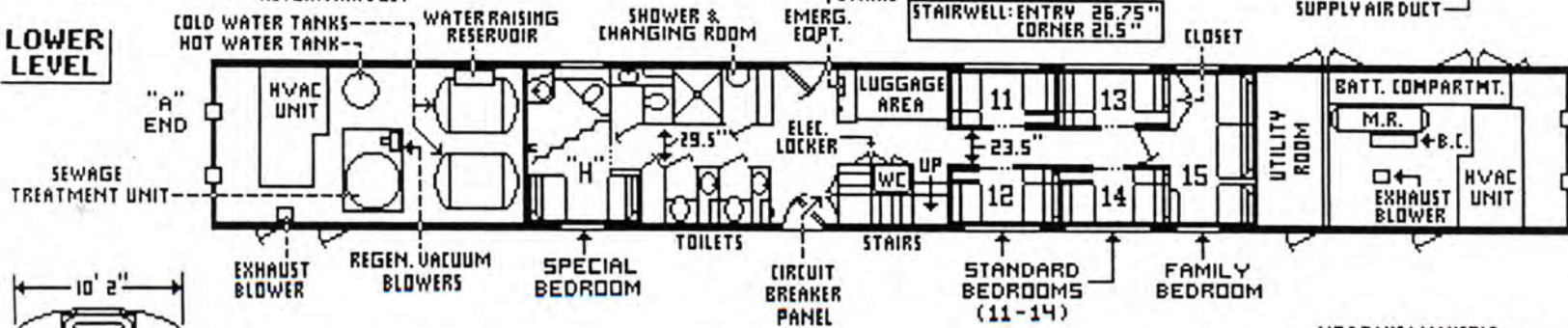

"STANDARD BEDROOMS" WERE FORMERLY CALLED "ECONOMY BEDROOMS"

SUPERLINER II DELUXE SLEEPER

Equipment Code: SD

100 MPH

Car Nos: 32500-32505

LEFT SIDE VIEW

BEDROOM PAIRS "B" & "C", "D" & "E" "J" & "K", "L" & "M" MAY BE CONVERTED TO BEDROOM SUITES.

DELUXE BEDROOM TOILETS CONTAIN A SHOWER.

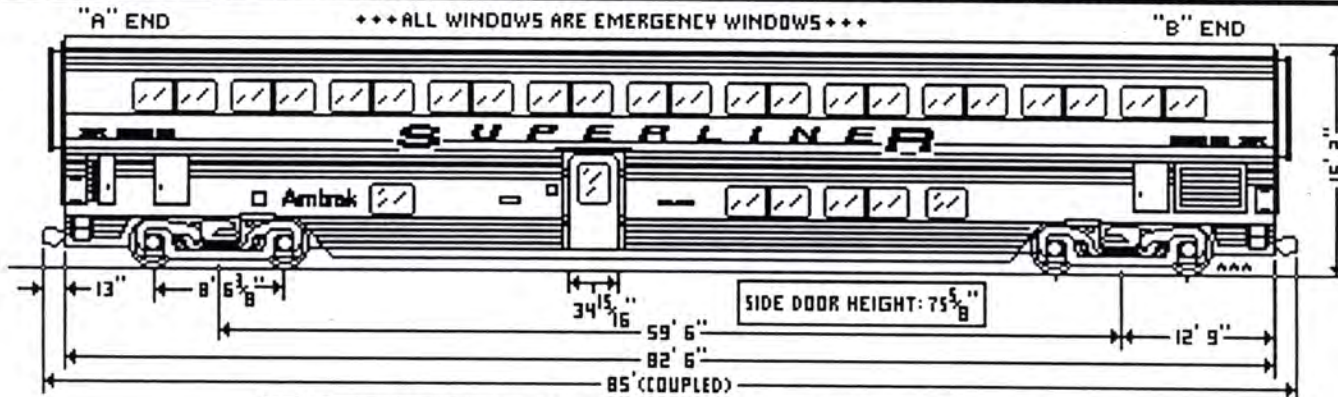

UPPER LEVEL

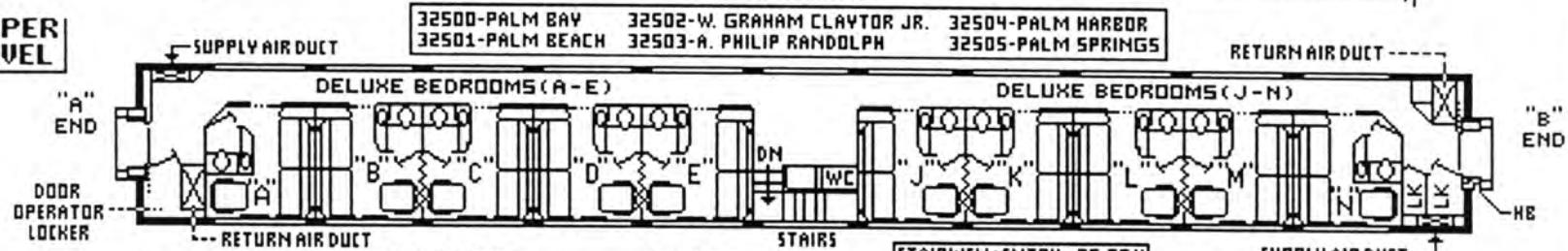

LOWER LEVEL

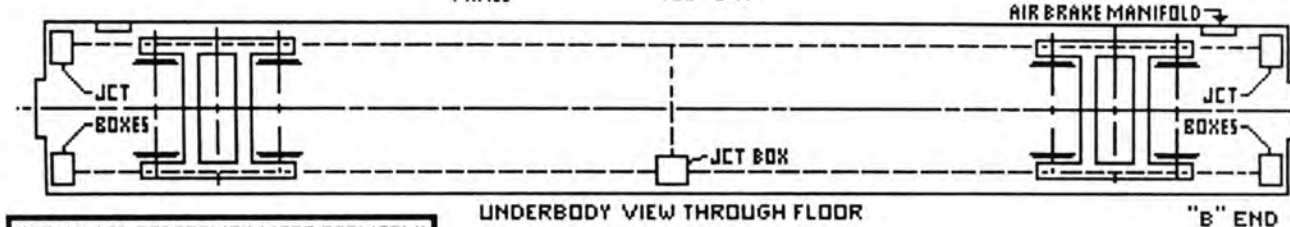
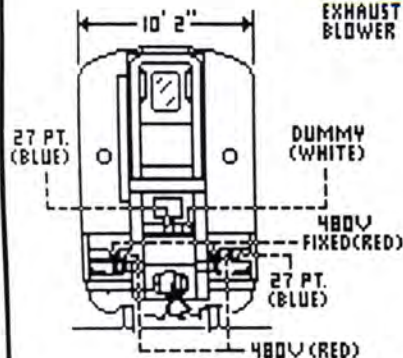
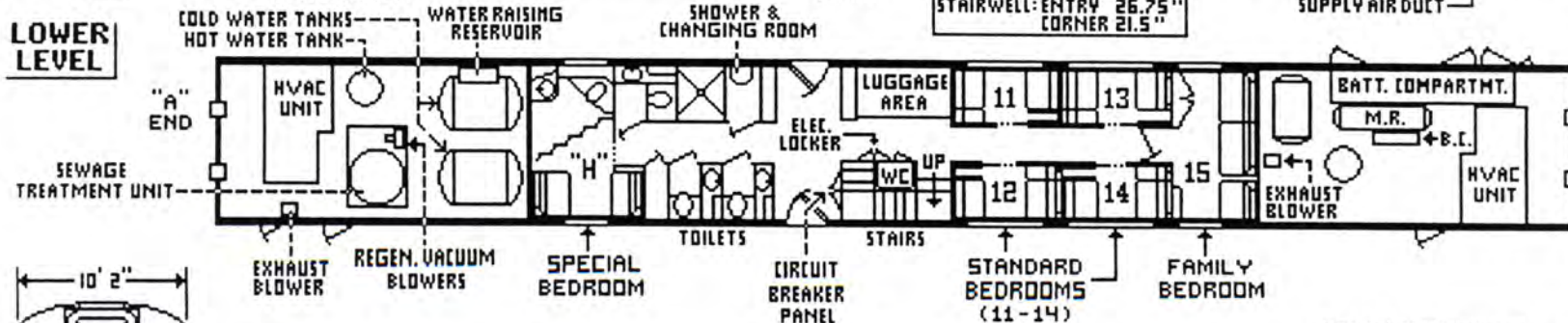

"STANDARD BEDROOMS" WERE FORMERLY CALLED "ECONOMY BEDROOMS"

SUPERLINER LOUNGE

Equipment Code: SR

100 MPH

Car Nos: 33000-33024

LEFT SIDE VIEW

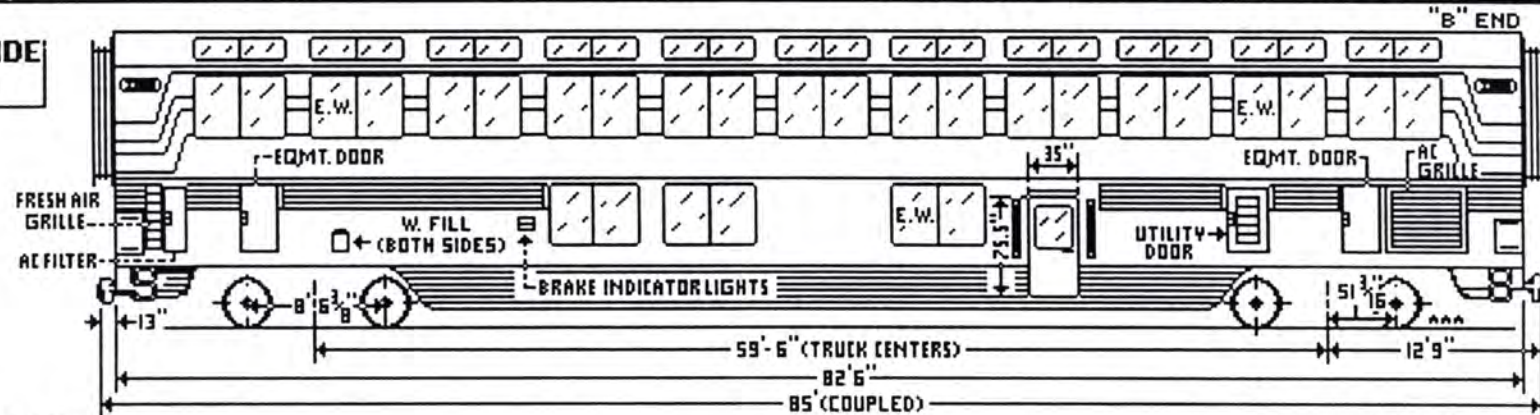

UPPER LEVEL

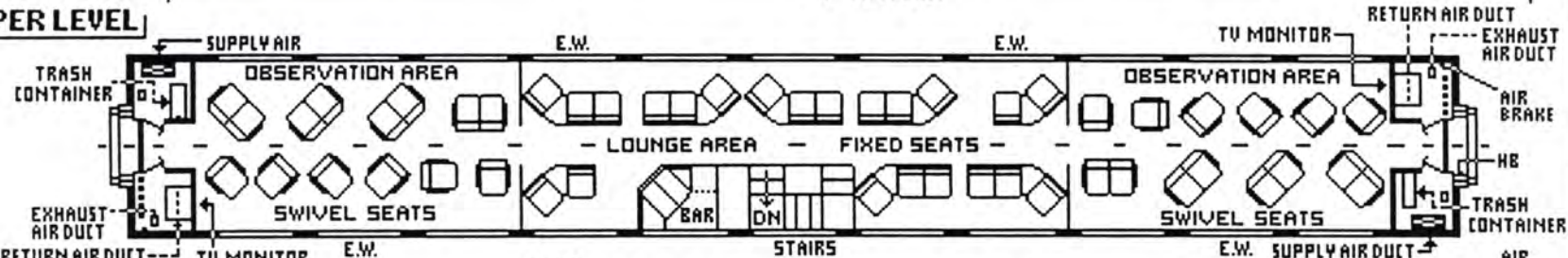

LOWER LEVEL

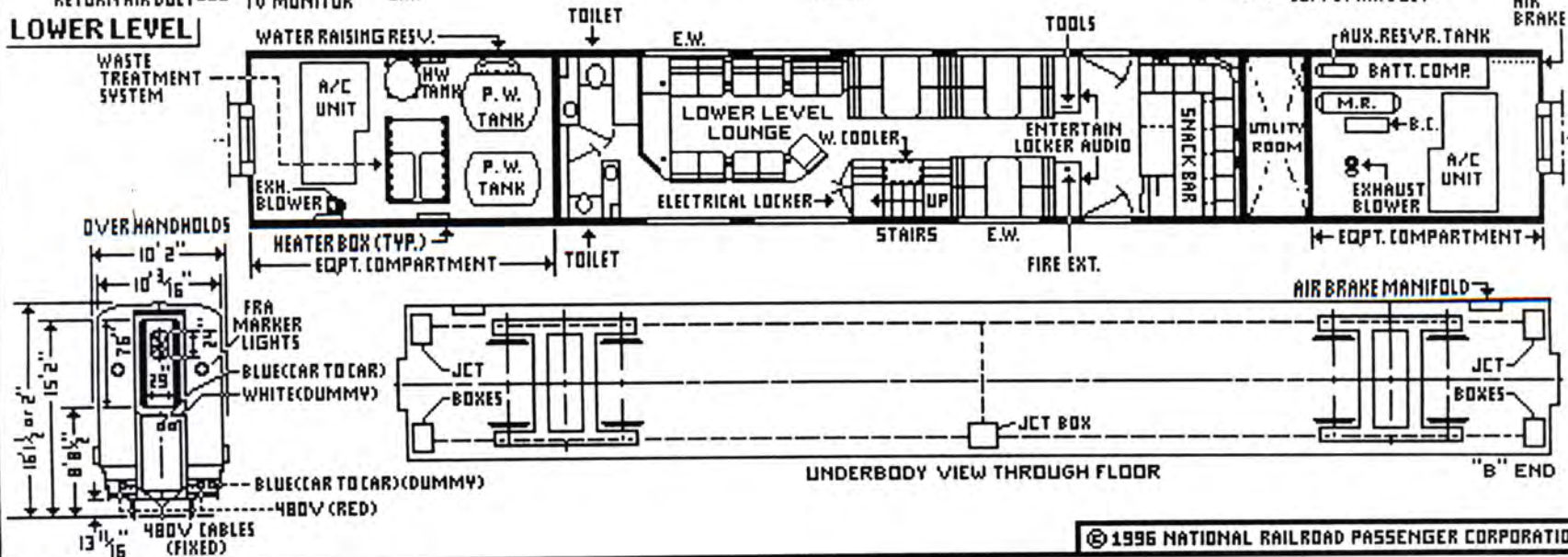

UNDERBODY VIEW THROUGH FLOOR

SUPERLINER II LOUNGE

Equipment Code: SR

100 MPH

Car Nos: 33025-33049

LEFT SIDE VIEW

END DOOR HEIGHT: 6' 4 1/8"
WIDTH: 31 1/2"

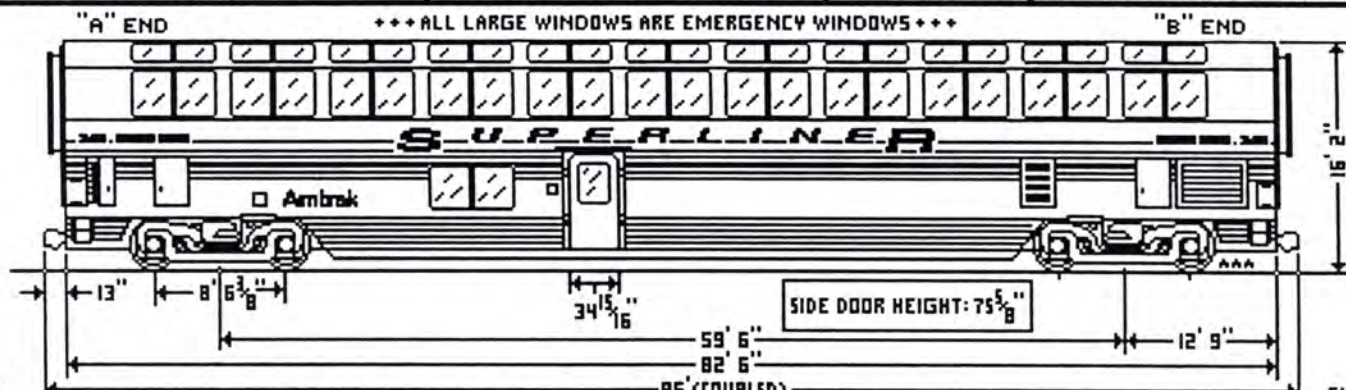

UPPER LEVEL

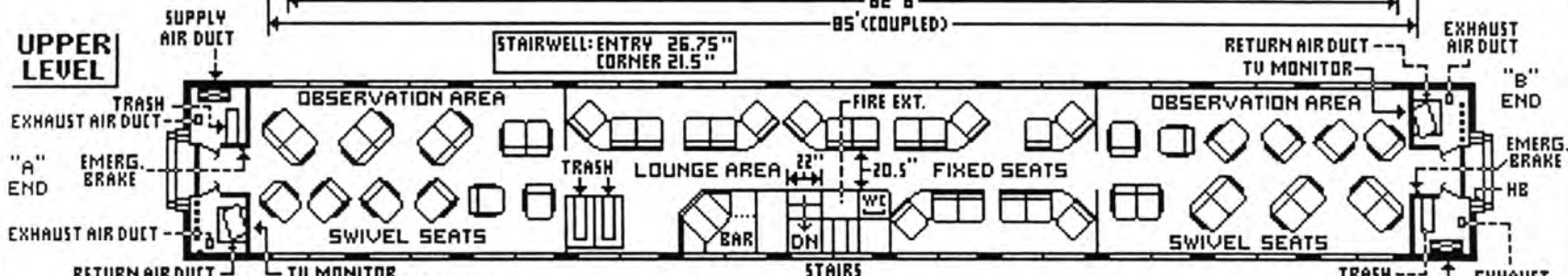

LOWER LEVEL

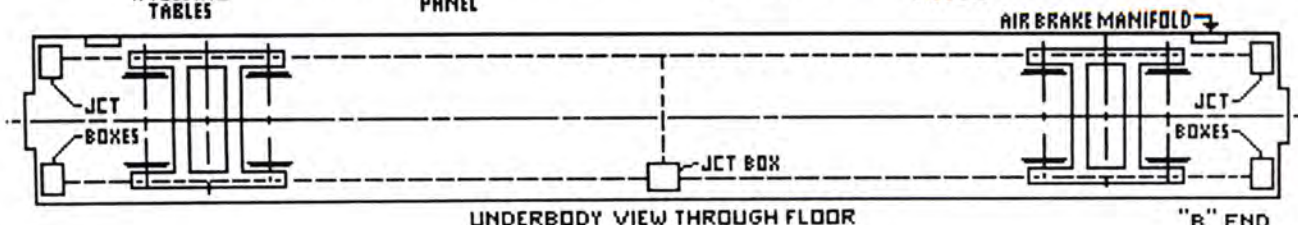
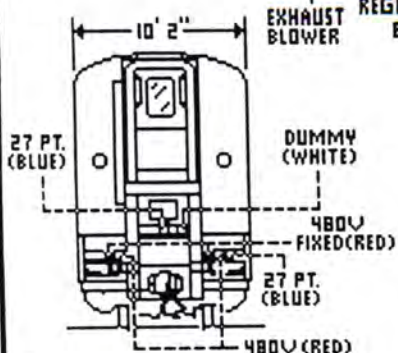
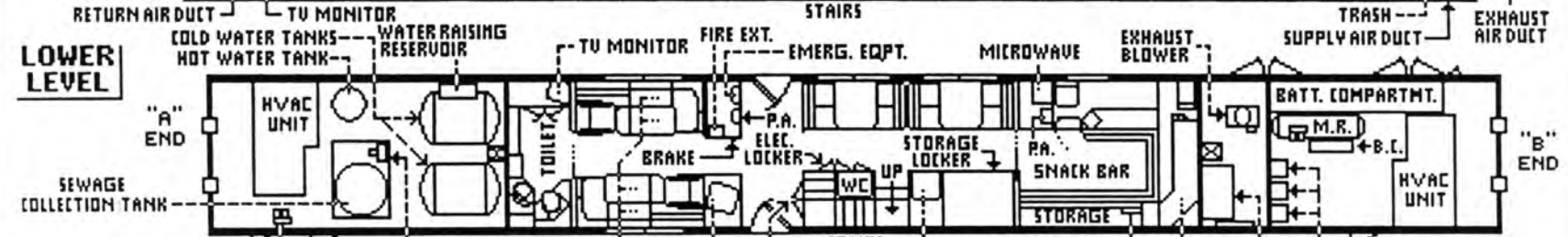

SUPERLINER COACH

Equipment Code: SC

100 MPH

Car Nos: 34000-34101

LEFT SIDE VIEW

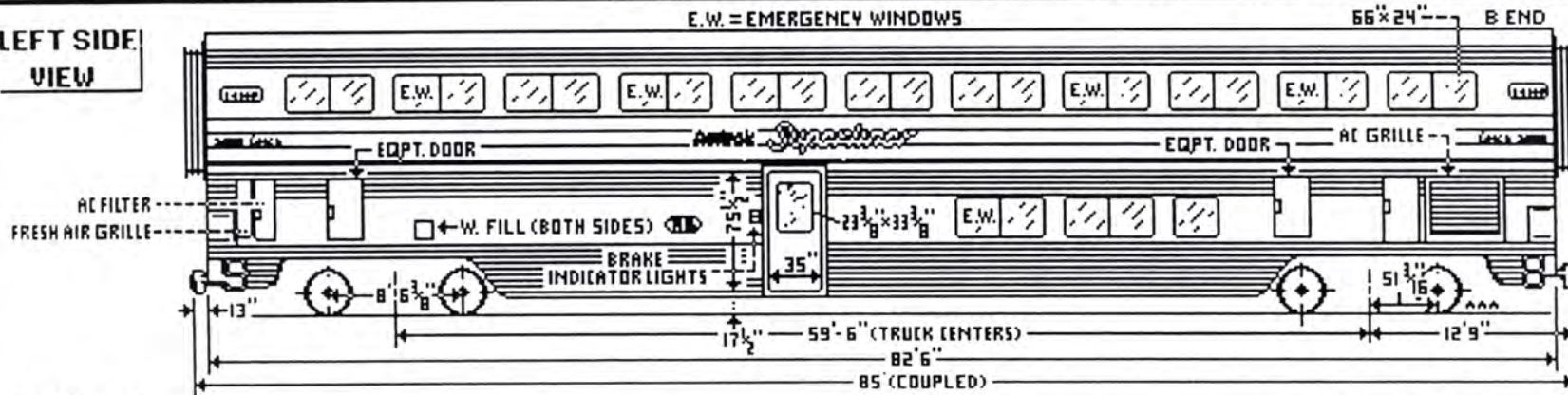

UPPER LEVEL

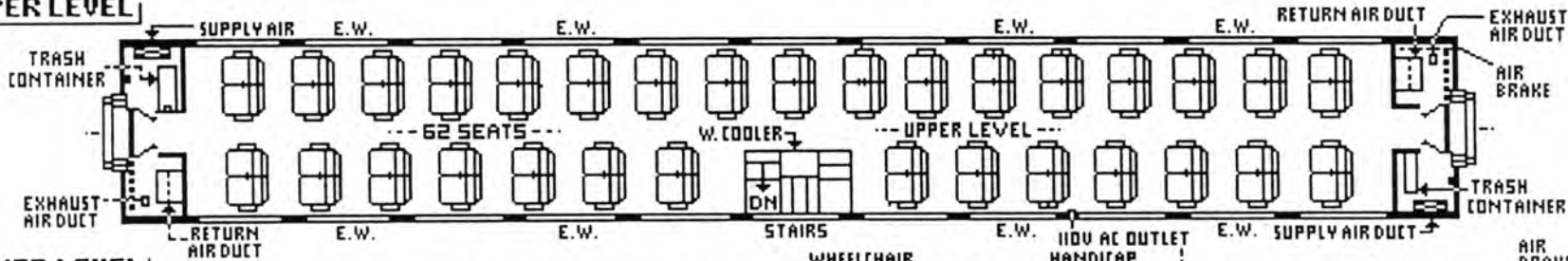

LOWER LEVEL

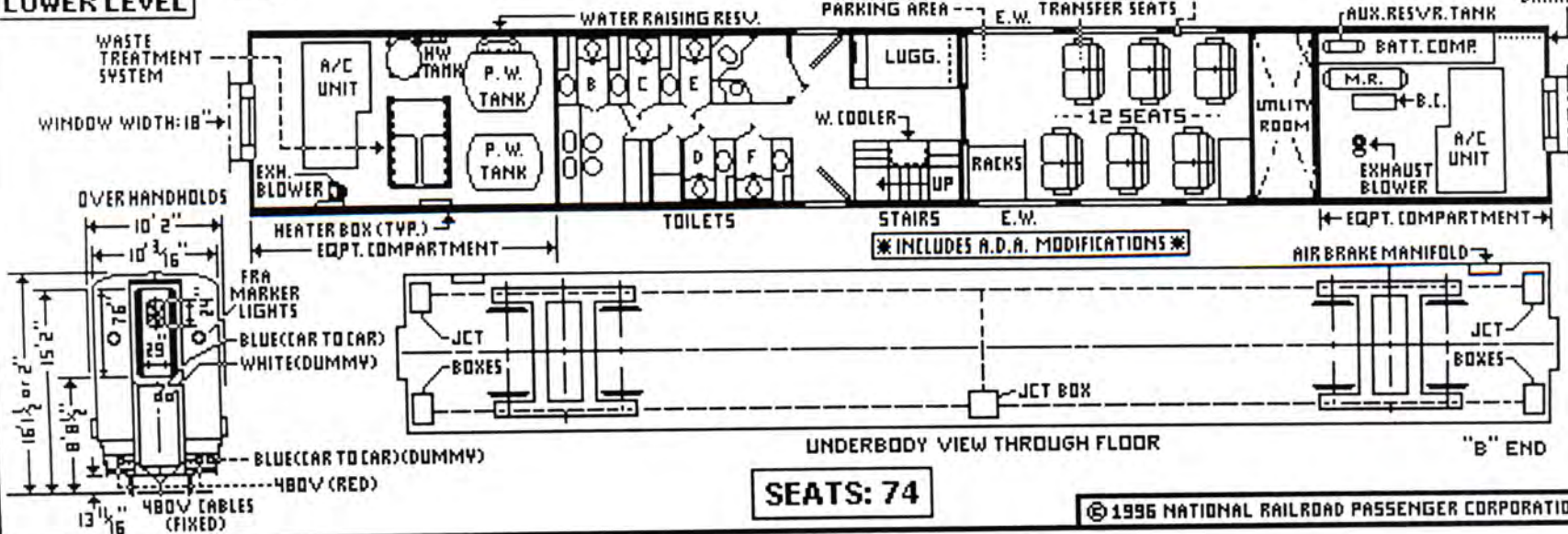

SEATS: 74

SUPERLINER II COACH

Equipment Code: SC

100 MPH

Car Nos: 34102-34139

LEFT SIDE VIEW

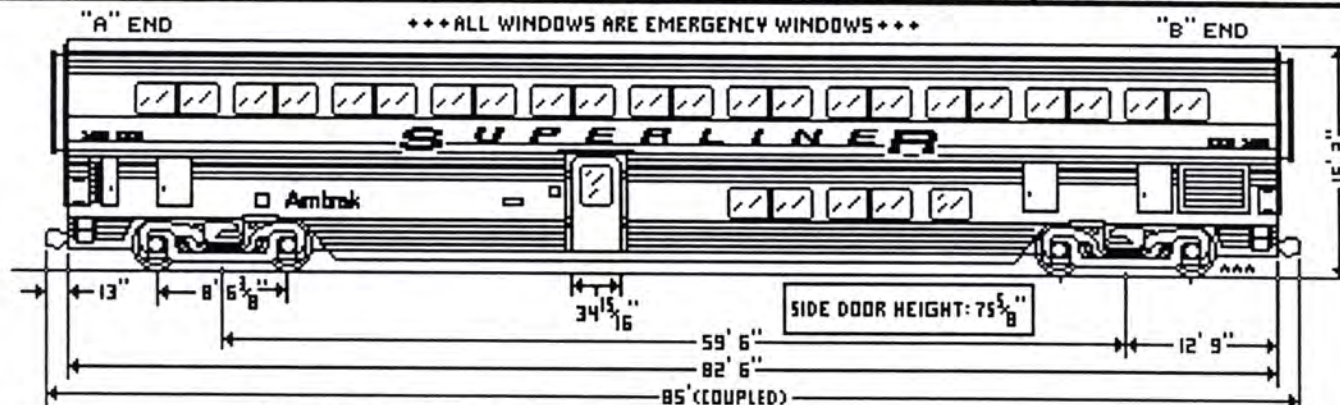

UPPER LEVEL

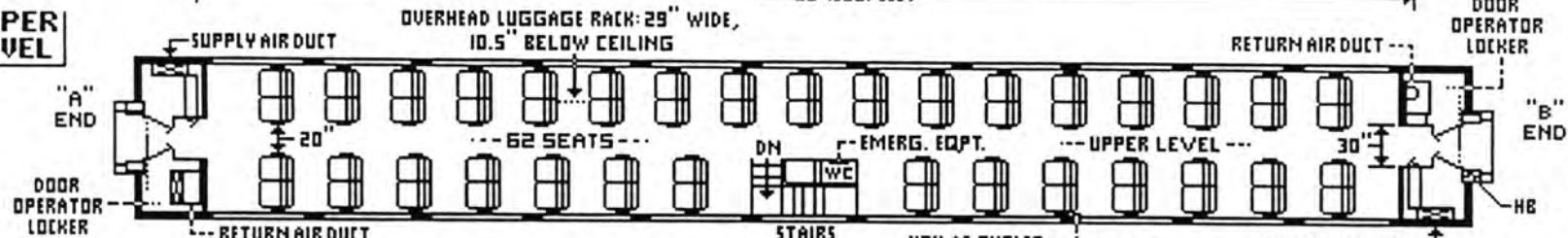

LOWER LEVEL

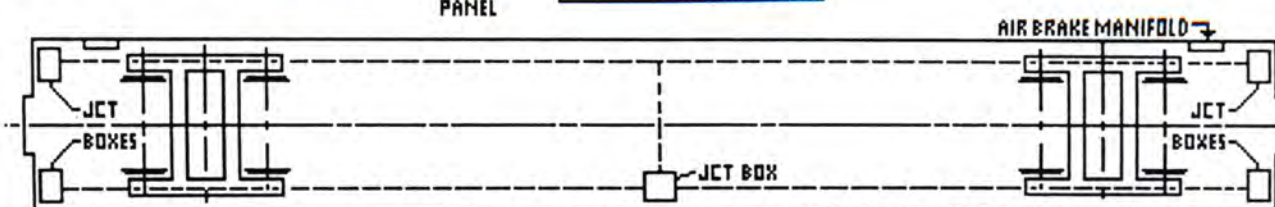
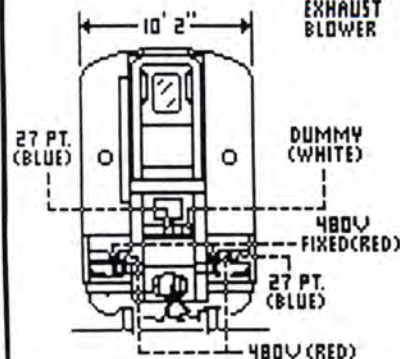

SEATS: 74

SUPERLINER SNACK-COACH

Equipment Code: SK

100 MPH

Car Nos: 35001-35011

LEFT SIDE VIEW

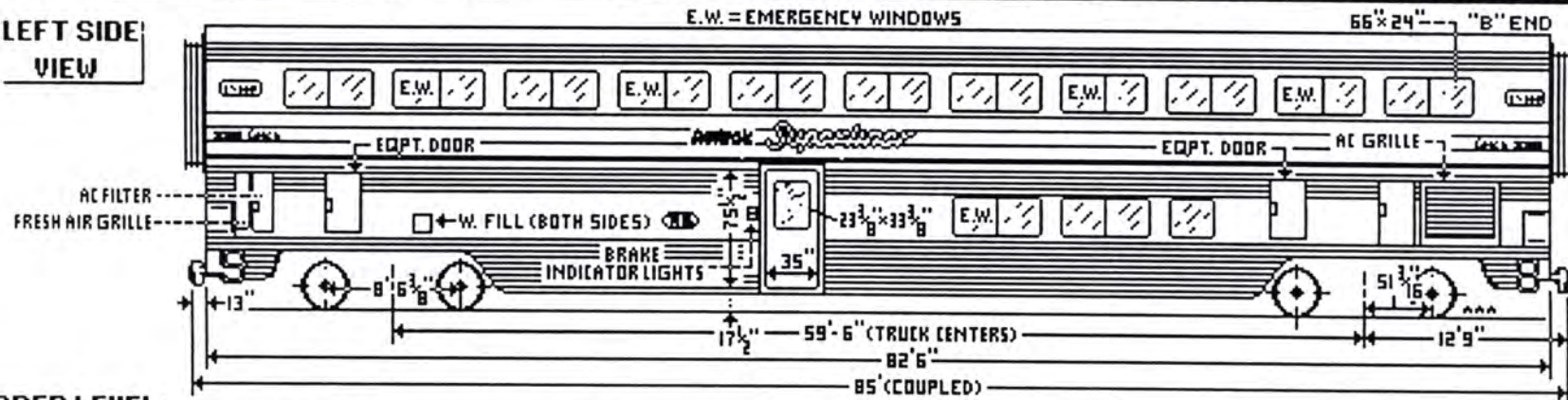

UPPER LEVEL

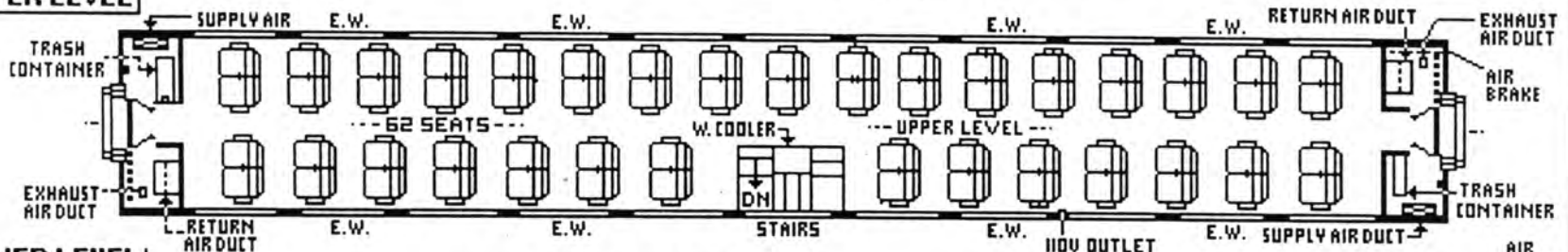

LOWER LEVEL

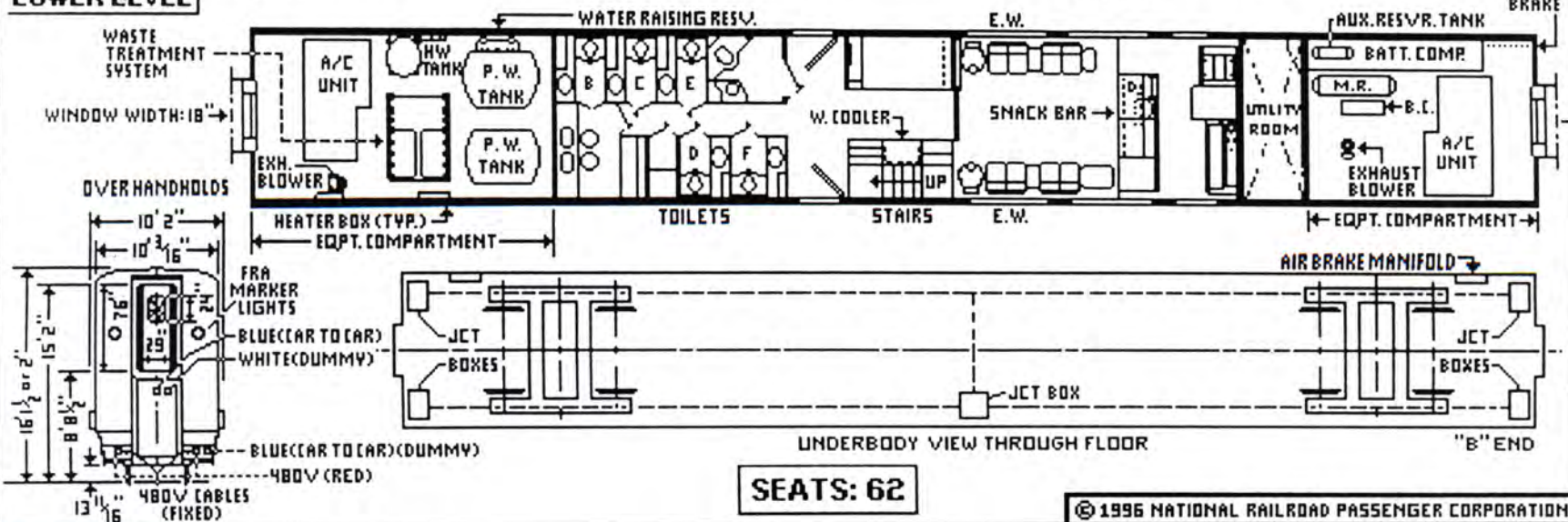

SUPERLINER DINER

Equipment Code: SF

100 MPH

Car Nos: 38000-38038

LEFT SIDE VIEW

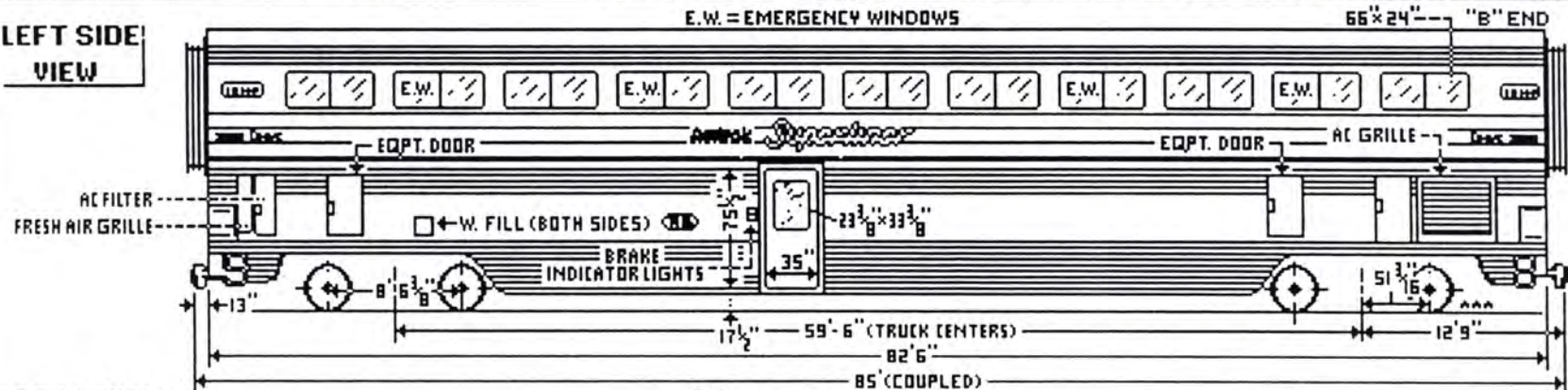

UPPER LEVEL

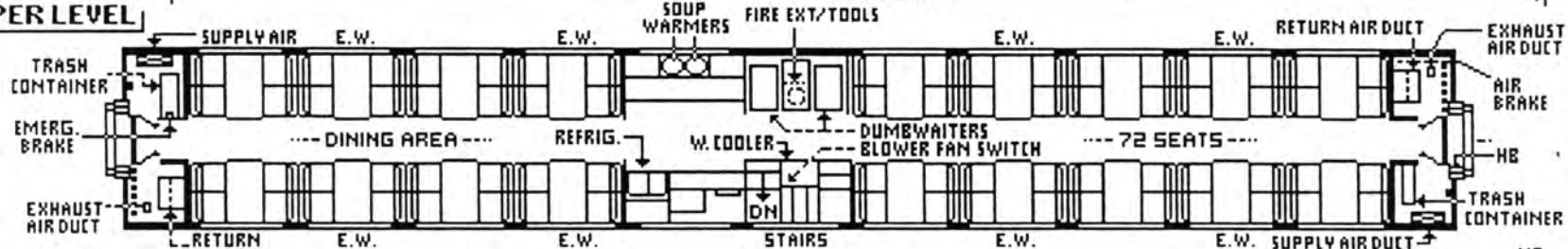

LOWER LEVEL

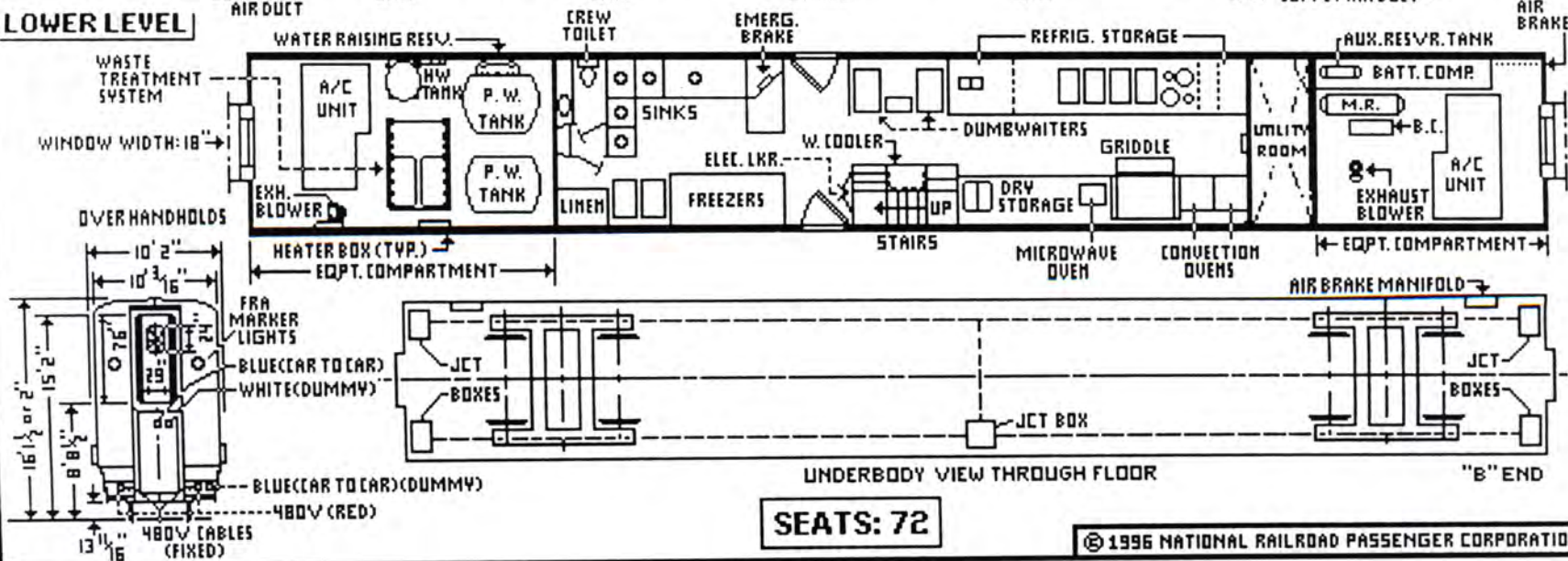

SEATS: 72

SUPERLINER II DINER

Equipment Code: SF

100 MPH

Car Nos: 38039-38068

LEFT SIDE VIEW

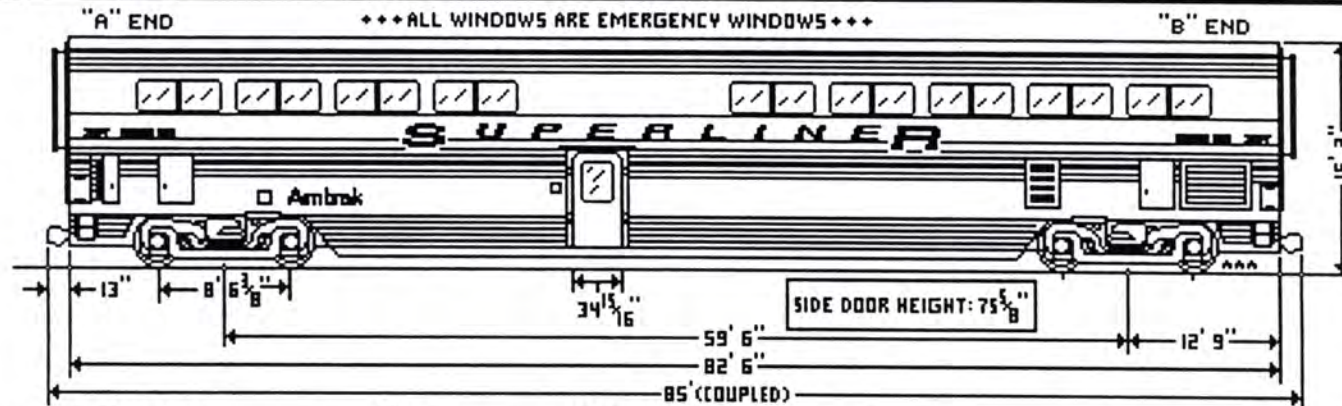

UPPER LEVEL

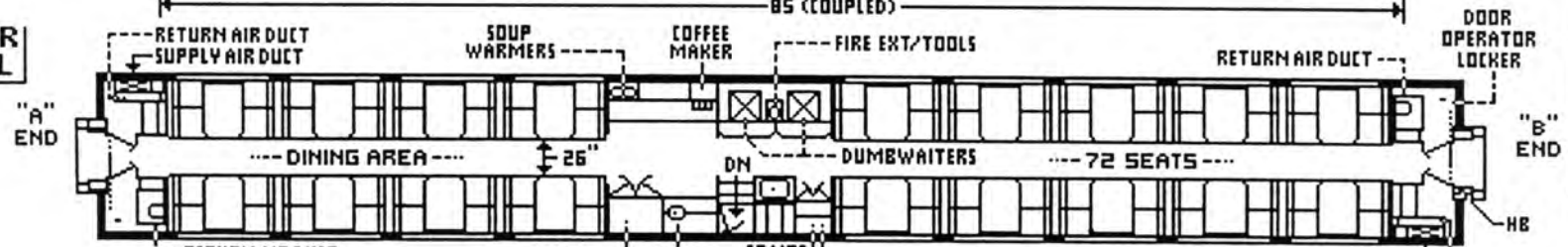

LOWER LEVEL

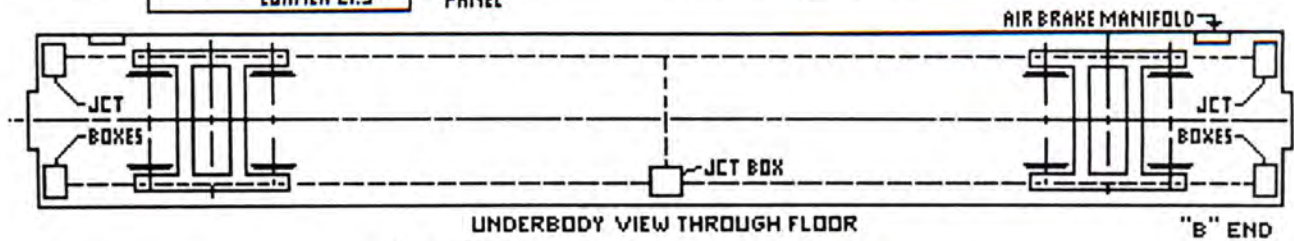
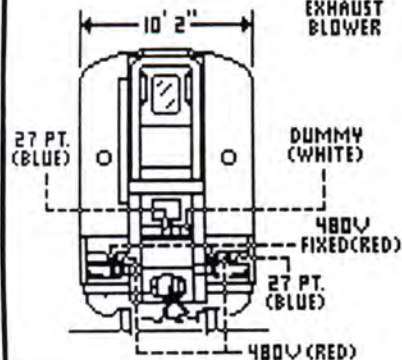
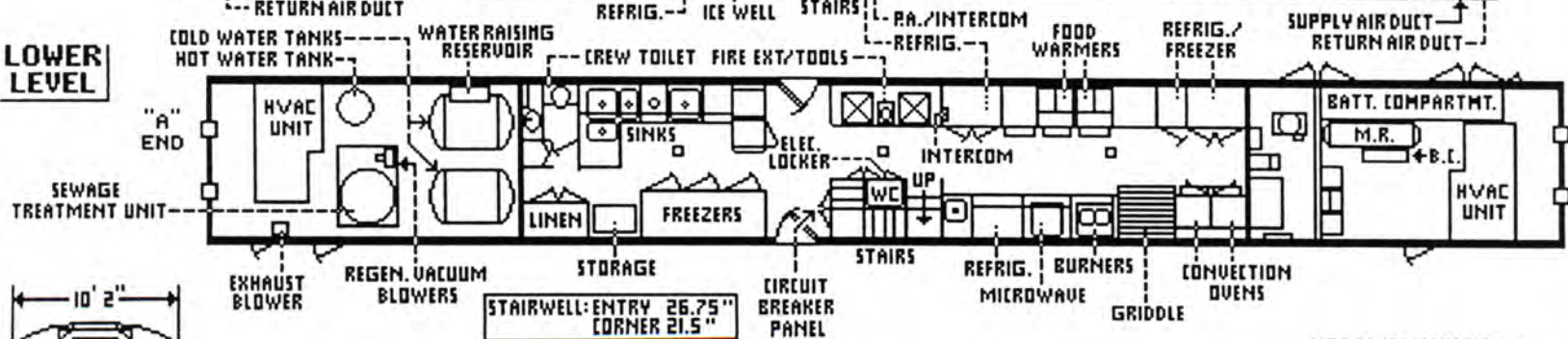

SEATS: 72

SUPERLINER II TRANSITION DORM

Equipment Code: ST

100 MPH

Car Nos: 39000-39011

LEFT SIDE VIEW

THIS IS A NON-REVENUE CREW CAR.

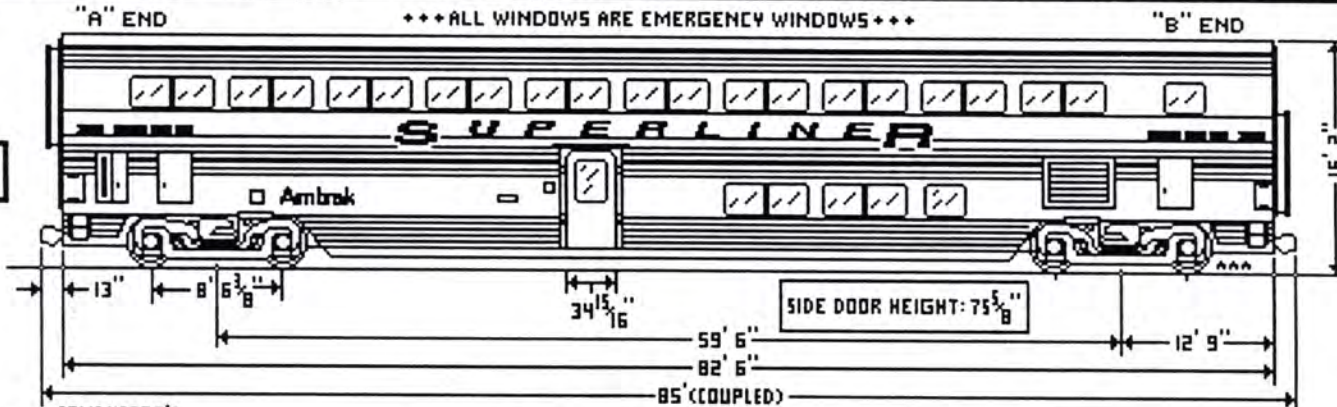

UPPER LEVEL

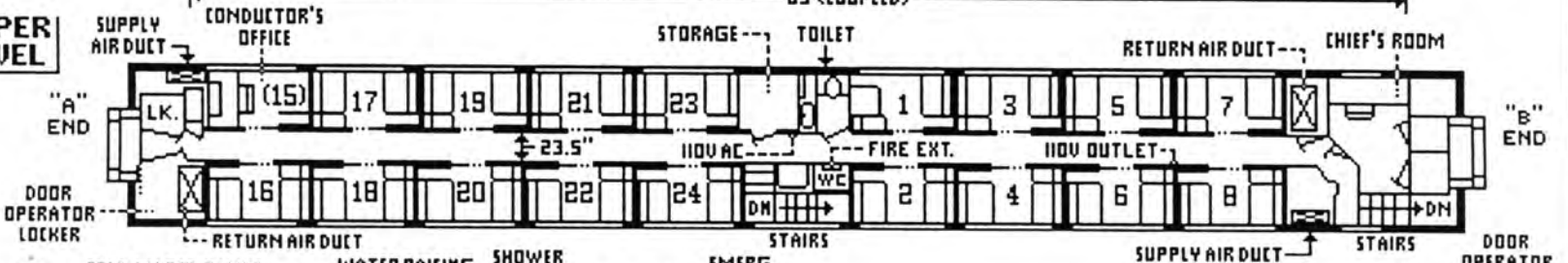

LOWER LEVEL

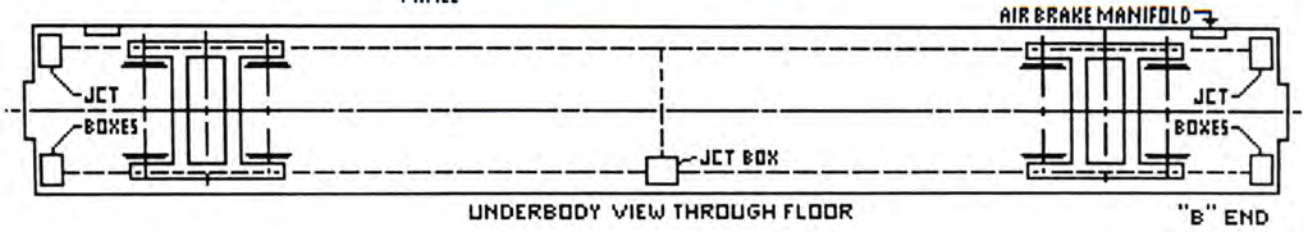
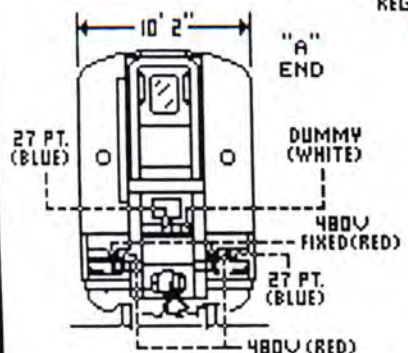
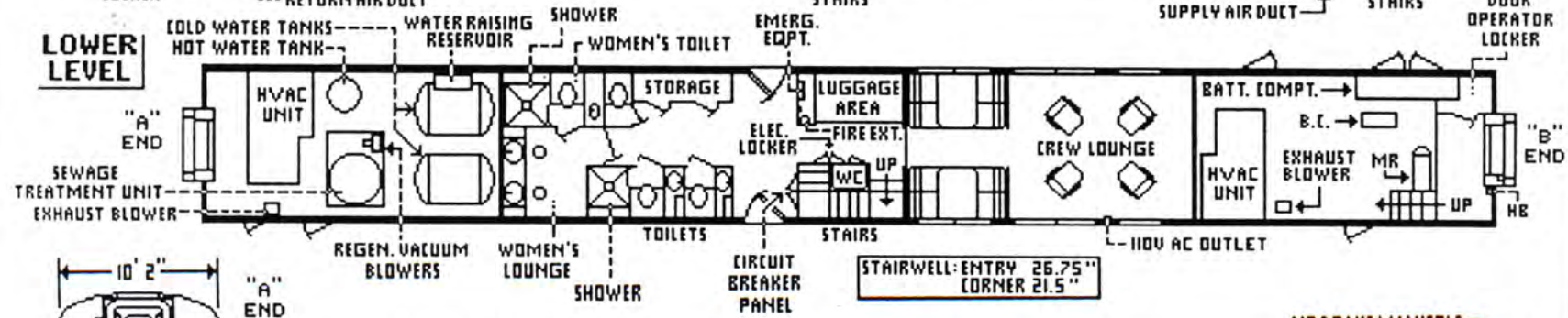

SUPERLINER II TRANSITION SLEEPER

Equipment Code: ST

100 MPH

Car Nos: 39012-39046

LEFT SIDE VIEW

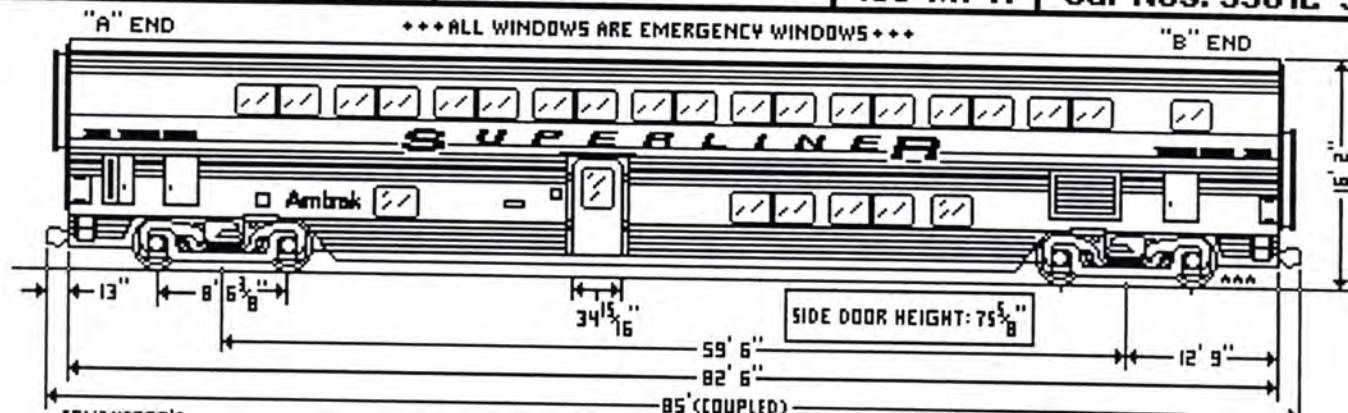

UPPER LEVEL

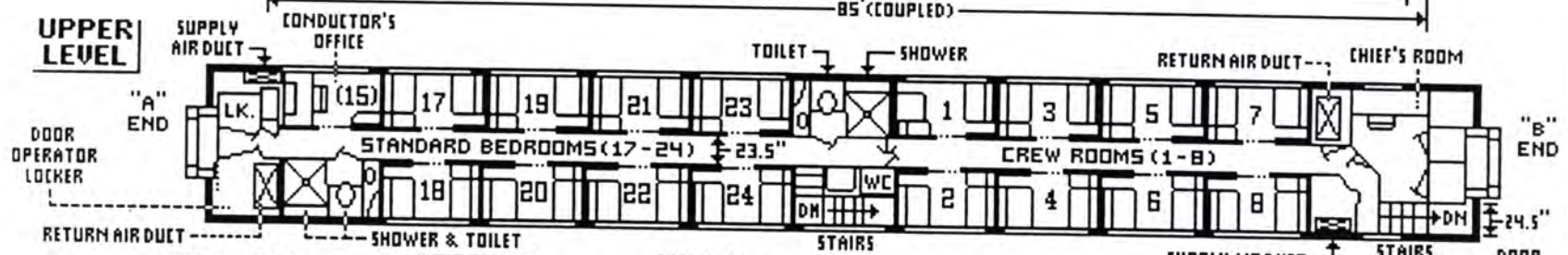

LOWER LEVEL

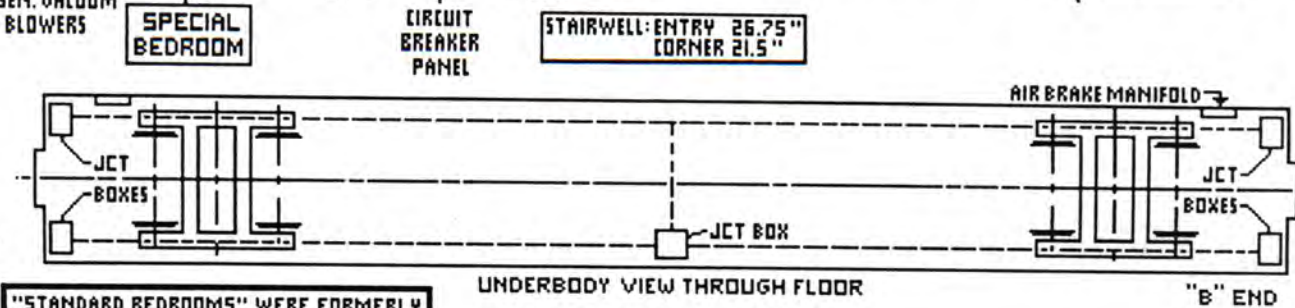
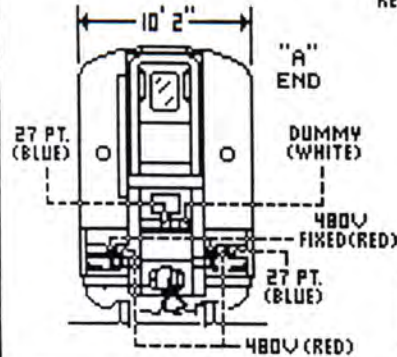
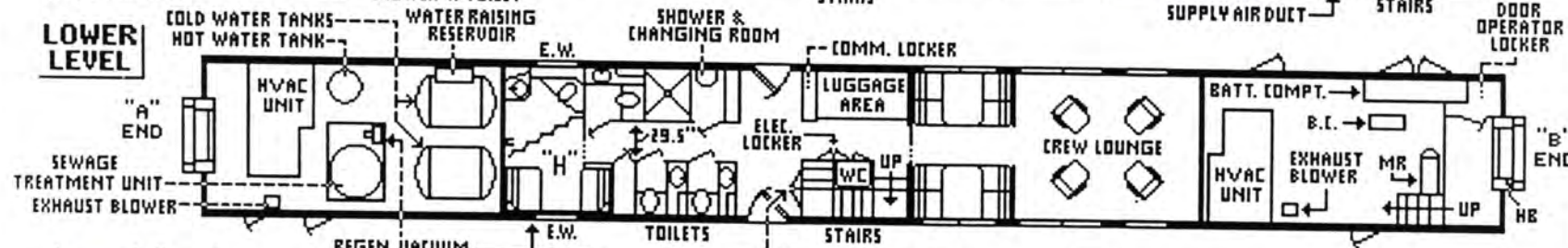

"STANDARD BEDROOMS" WERE FORMERLY CALLED "ECONOMY BEDROOMS"

HERITAGE TRANSITION DORM COACH

Eqpt. Code: ST

110 MPH

Car Nos: 39902-39908, 39911

LEFT SIDE VIEW

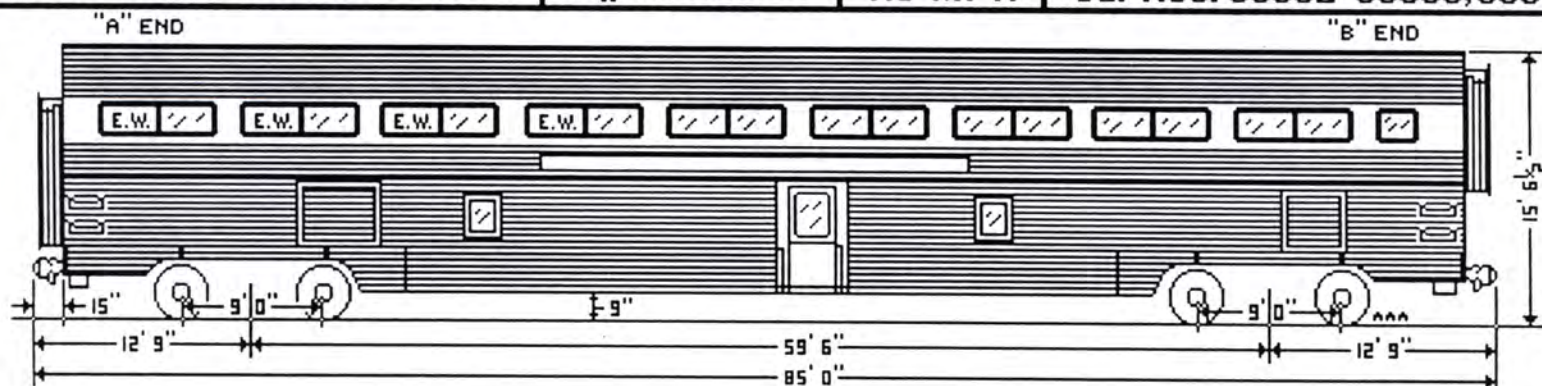

UPPER LEVEL

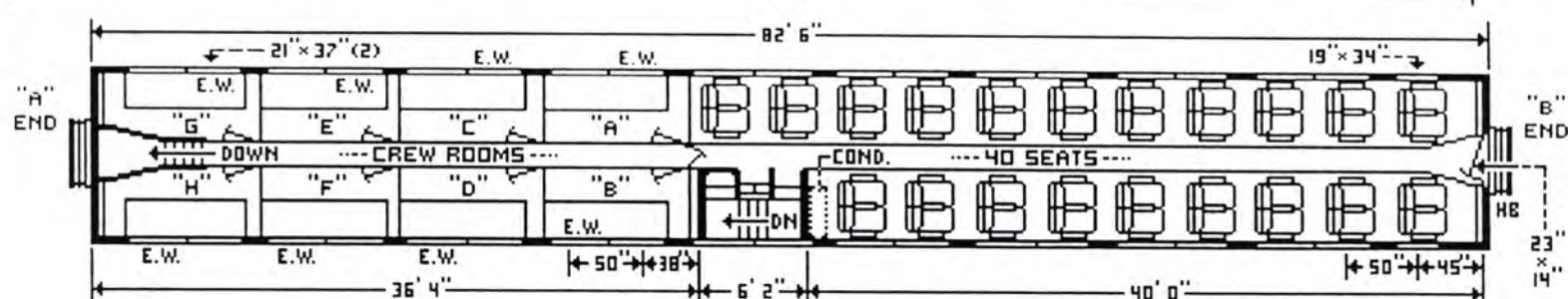

LOWER LEVEL

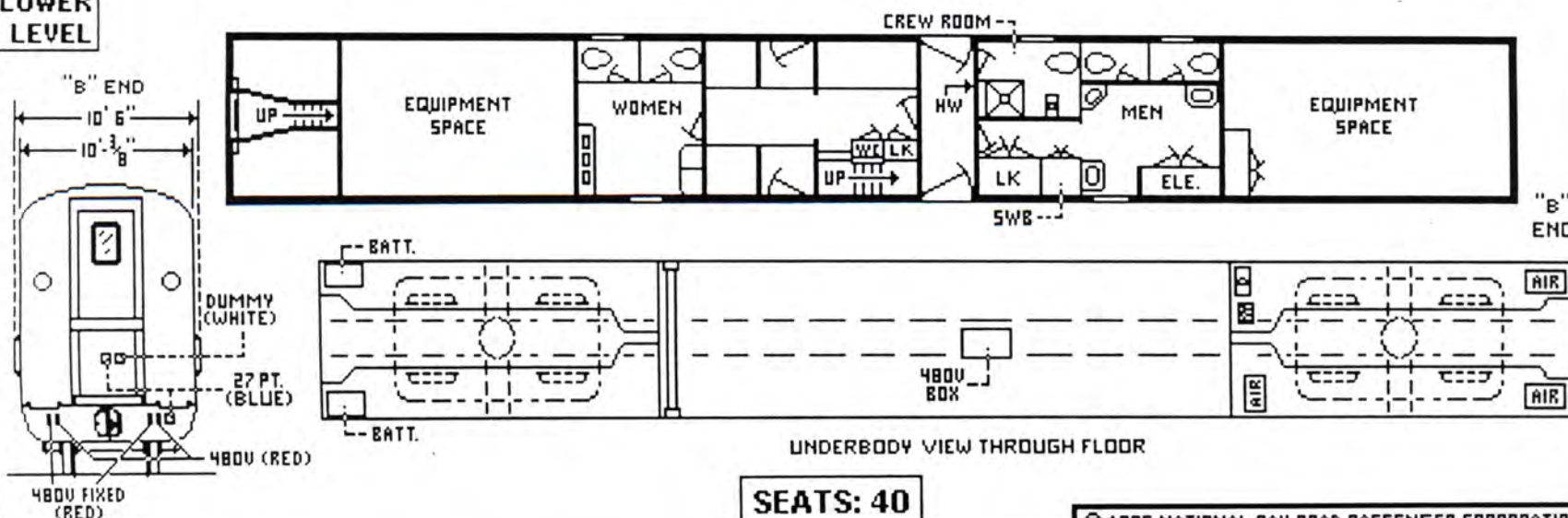

HERITAGE TRANSITION DORM COACH | Eqt. Code: ST | 110 MPH | Car #: 39909, 39914, 39918, 39926, 39933-39935, 39938

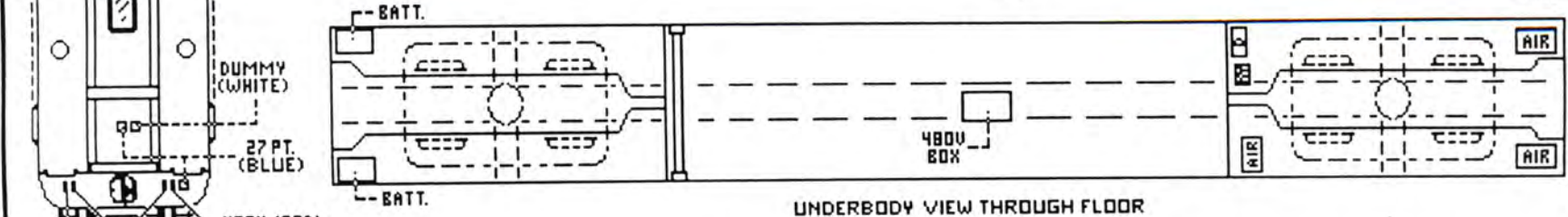
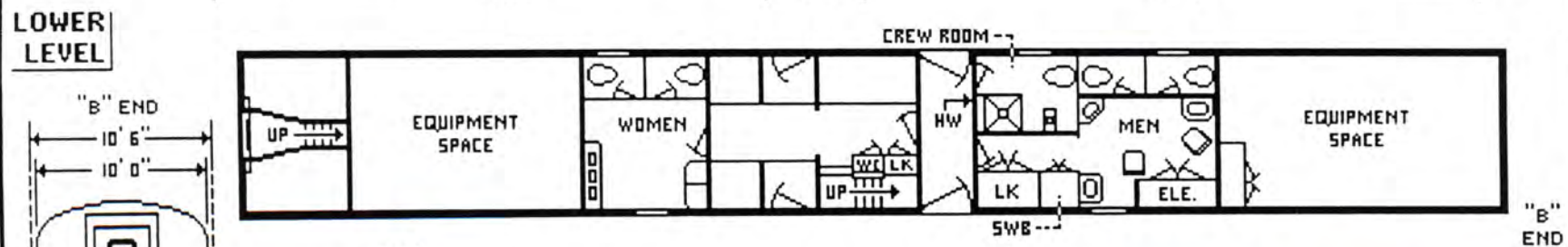
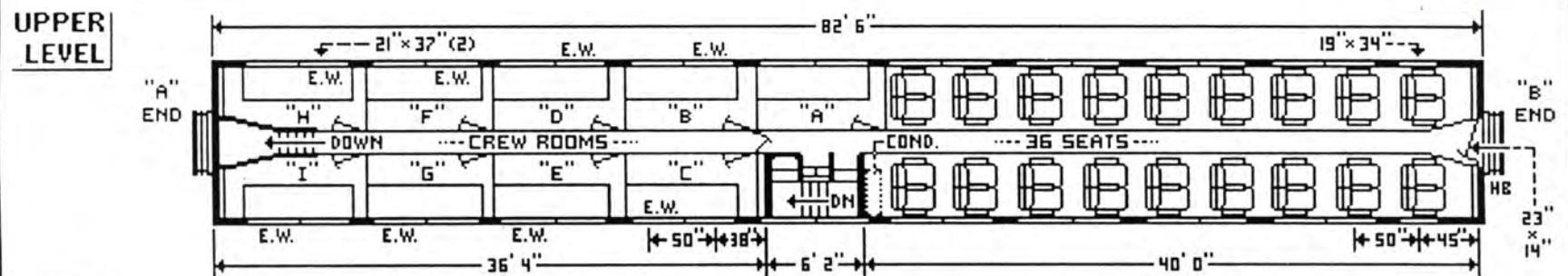
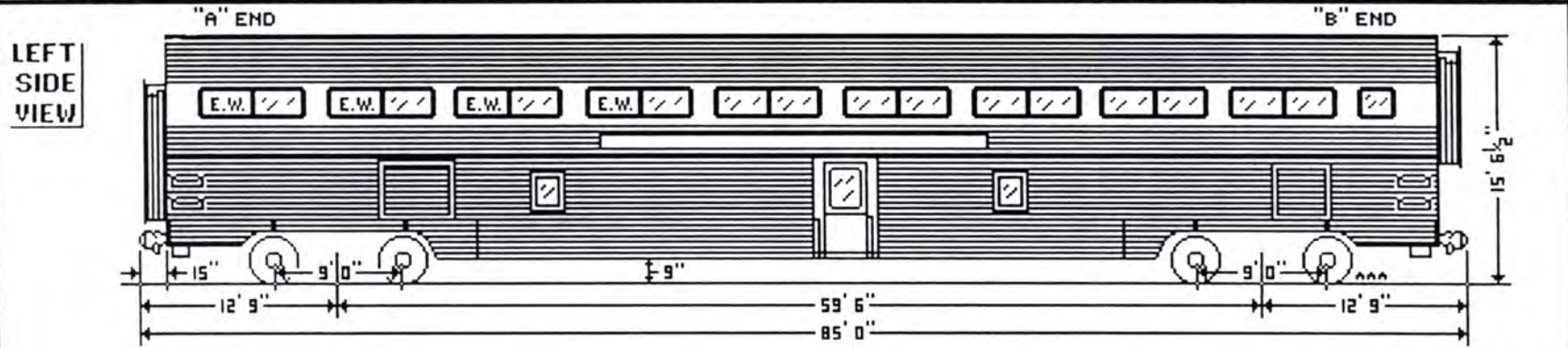

SEATS: 36

HERITAGE TRANSITION DORM COACH | Eqpt. Code: ST | 110 MPH | Car Nos: 39913, 39915-39917, 39919-39923

LEFT SIDE VIEW

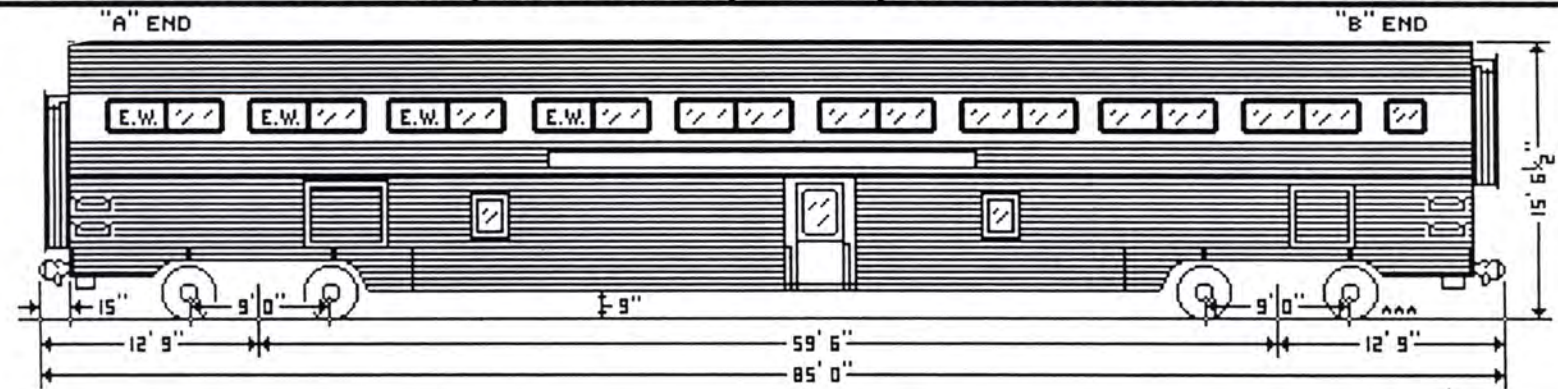

UPPER LEVEL

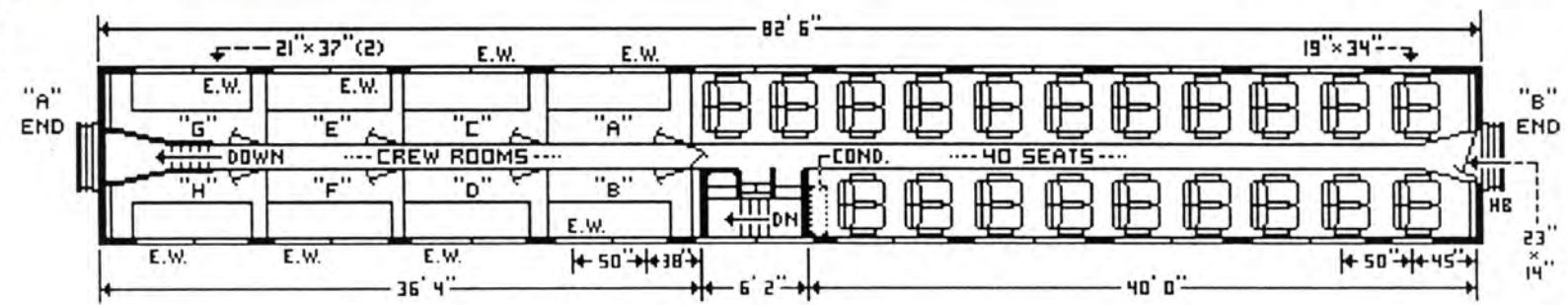

LOWER LEVEL

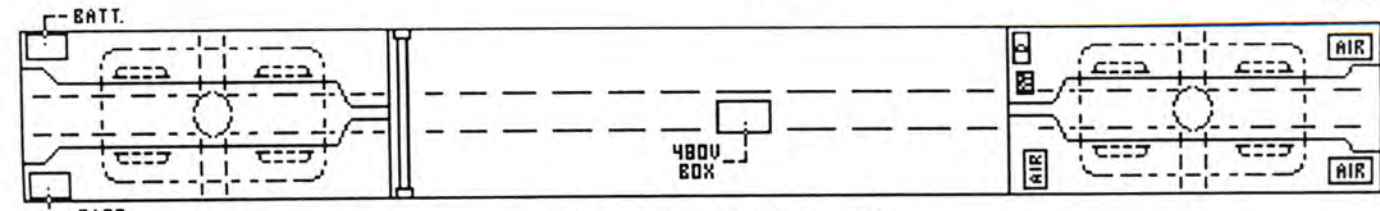
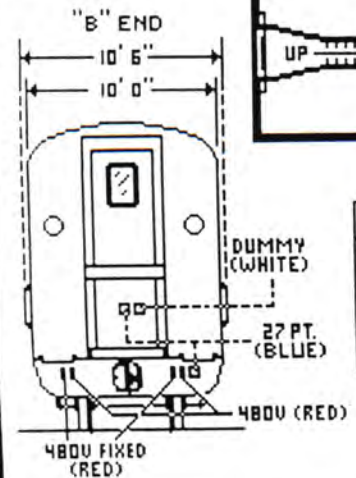
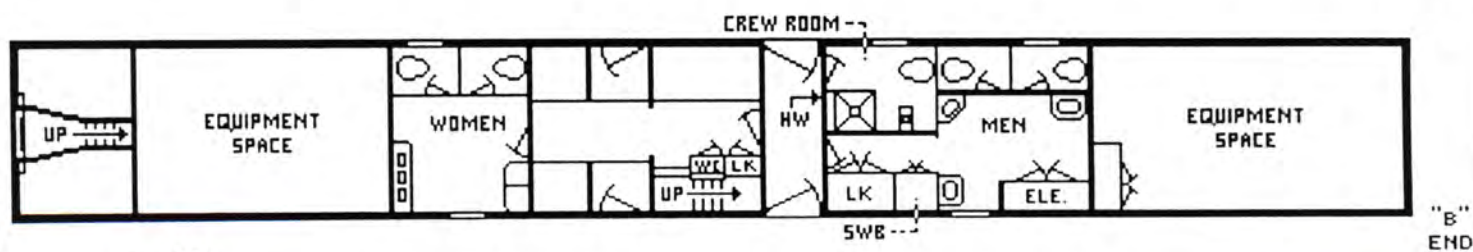

UNDERBODY VIEW THROUGH FLOOR

SEATS: 40

HERITAGE HIGH-LEVEL COACH

Equipment Code: HH

110 MPH

Car Nos: 39940-39964

**LEFT
SIDE
VIEW**

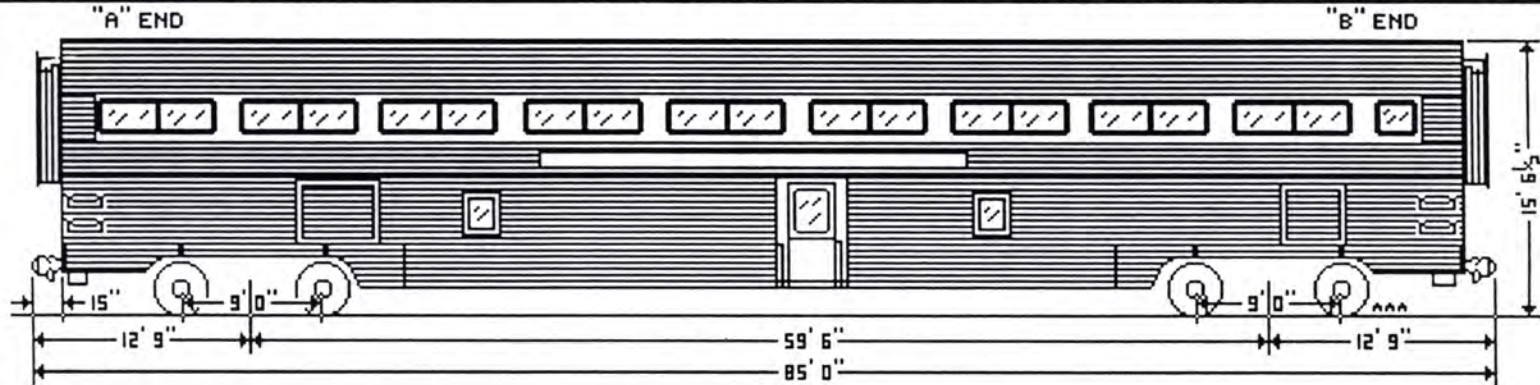

**UPPER
LEVEL**

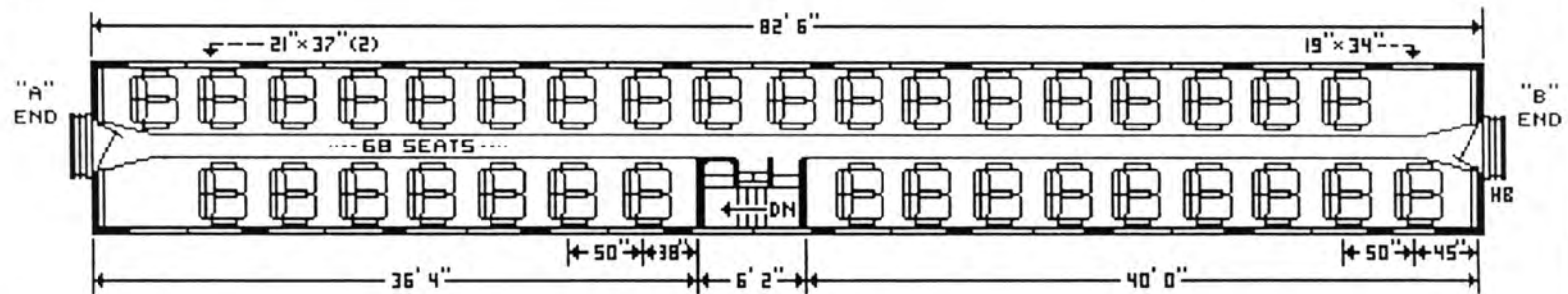

**LOWER
LEVEL**

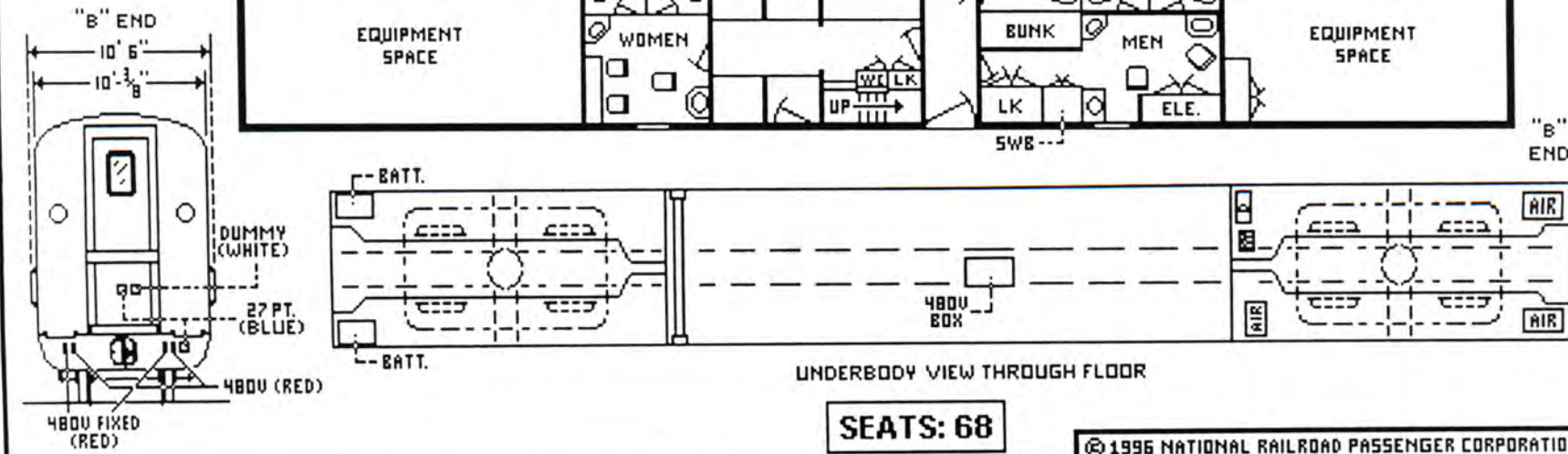

UNDERBODY VIEW THROUGH FLOOR

SEATS: 68

AMFLEET-I CAFE

Equipment Code: AF

125 MPH

Car Numbers: 43002-43043

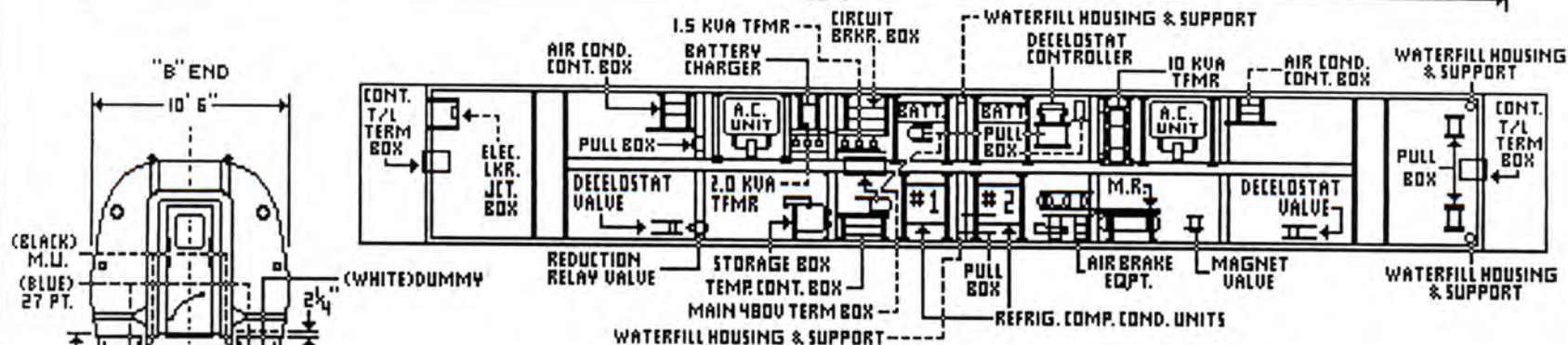
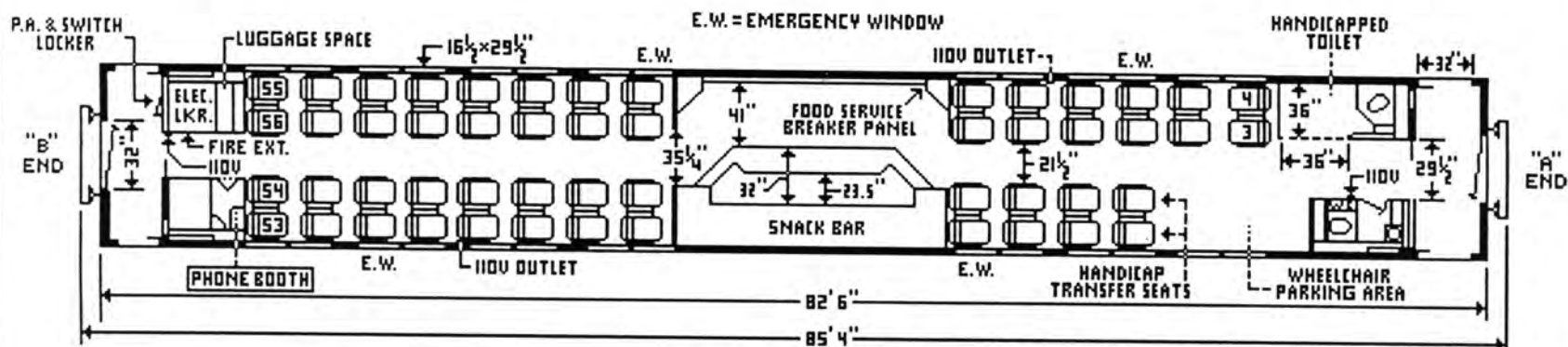
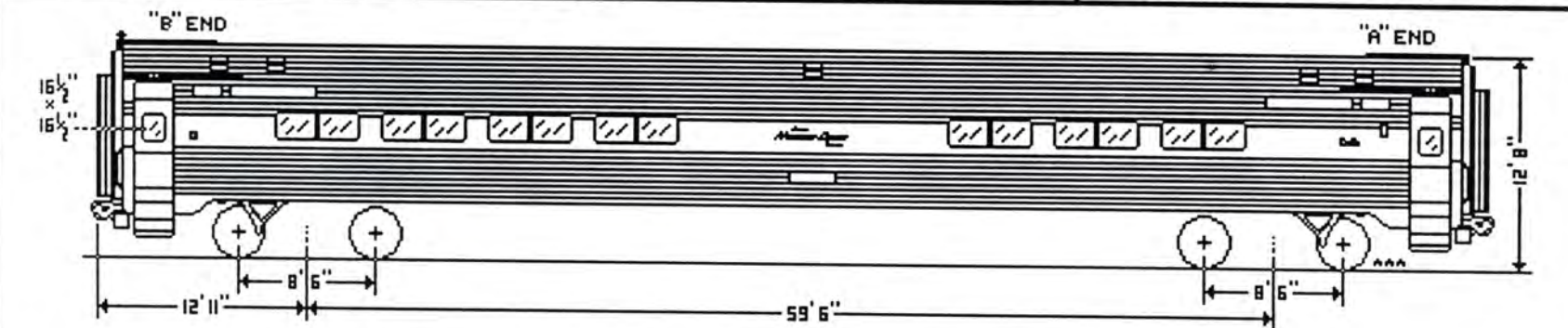

UNDERBODY VIEW THROUGH FLOOR

* INCLUDES A.D.A. MODIFICATIONS *

SEATS: 52

ALL-TABLE METROLINER DINETTE

Equipment Code: MF

125 MPH

Car Numbers: 43351-43359

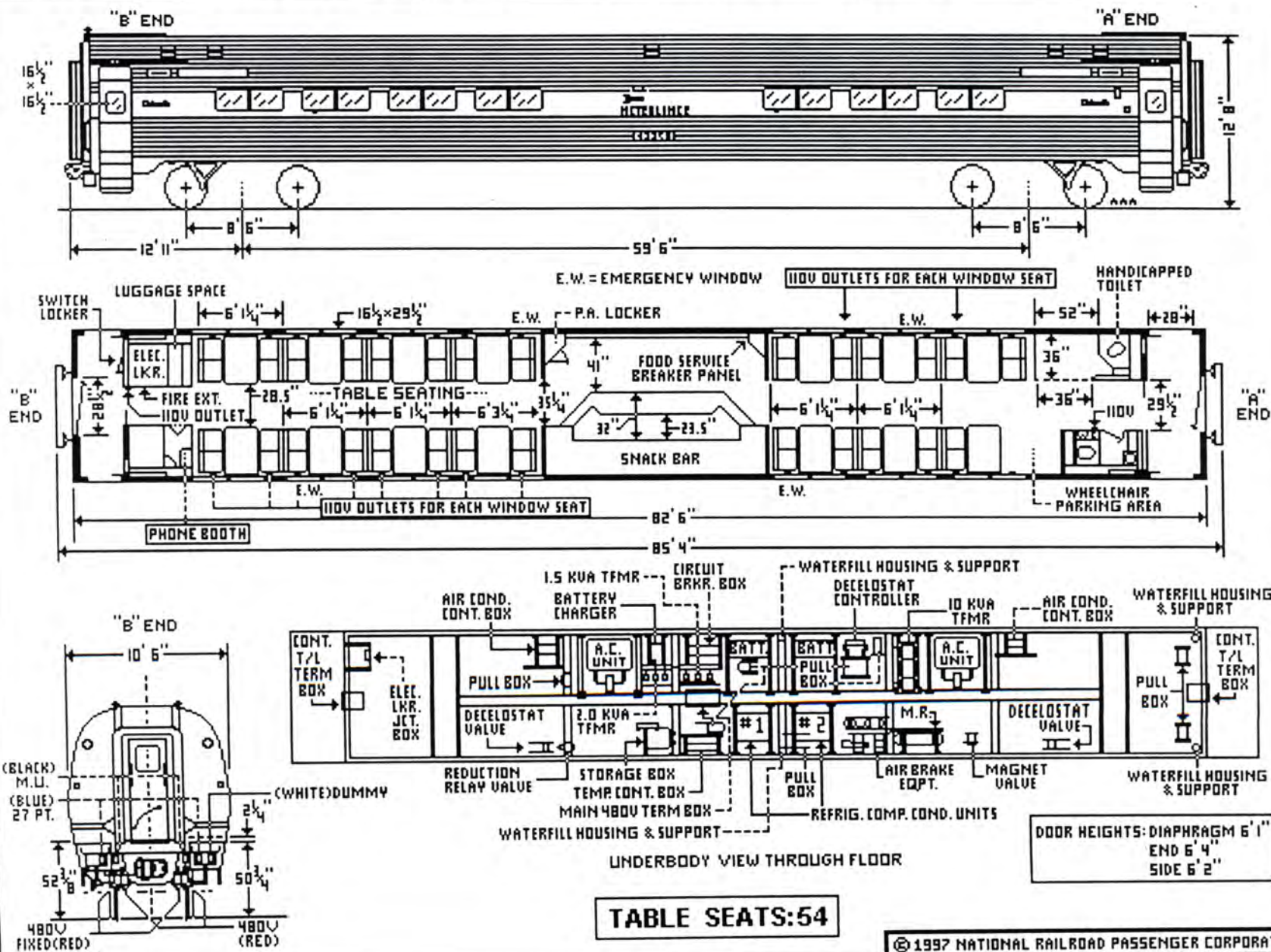

AMFLEET-I COACH

Eqpt. Code: A0

125 MPH

Car Numbers: 44004-44220, 44227-44279

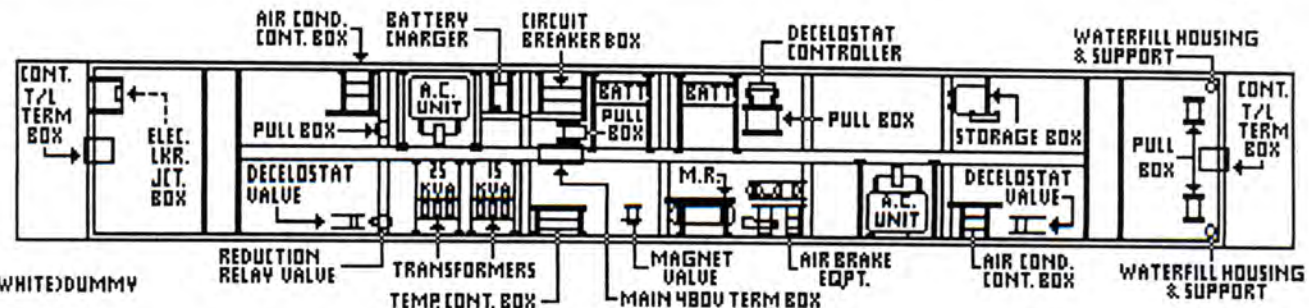
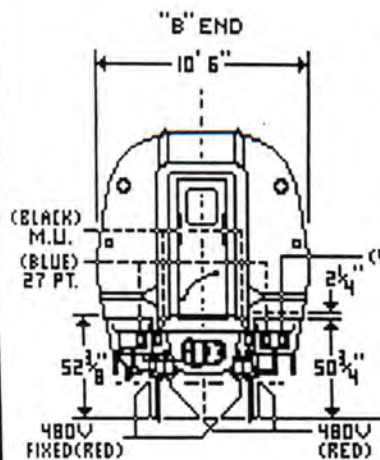
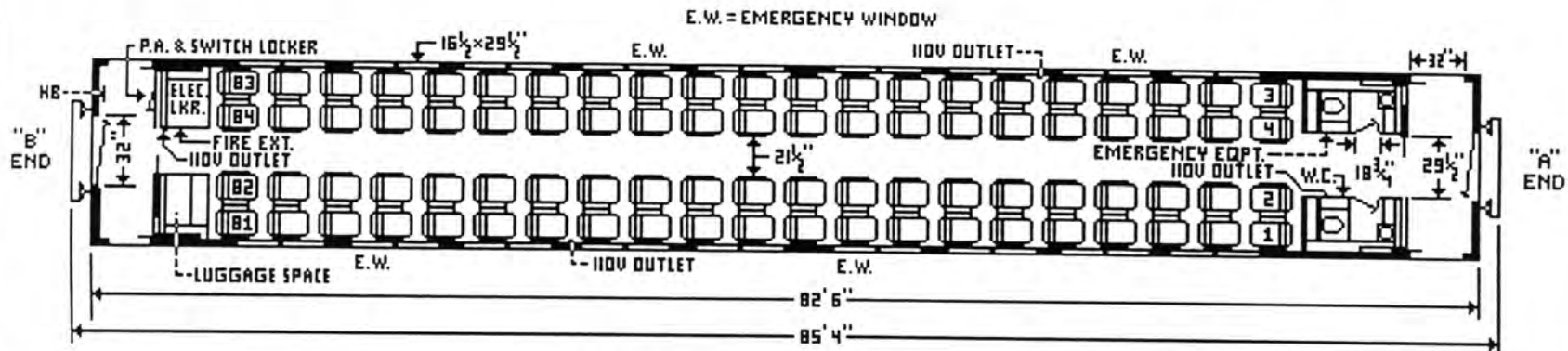
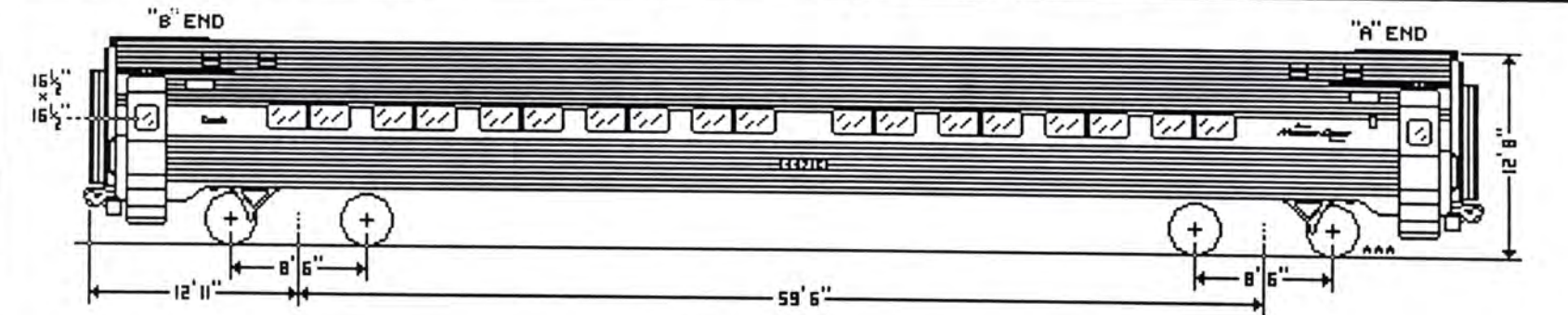

UNDERBODY VIEW THROUGH FLOOR

SEATS: 84

MICHIGAN PUSH-PULL COACH

Equipment Code: AM

125 MPH

Car Nos: 44550, 44551

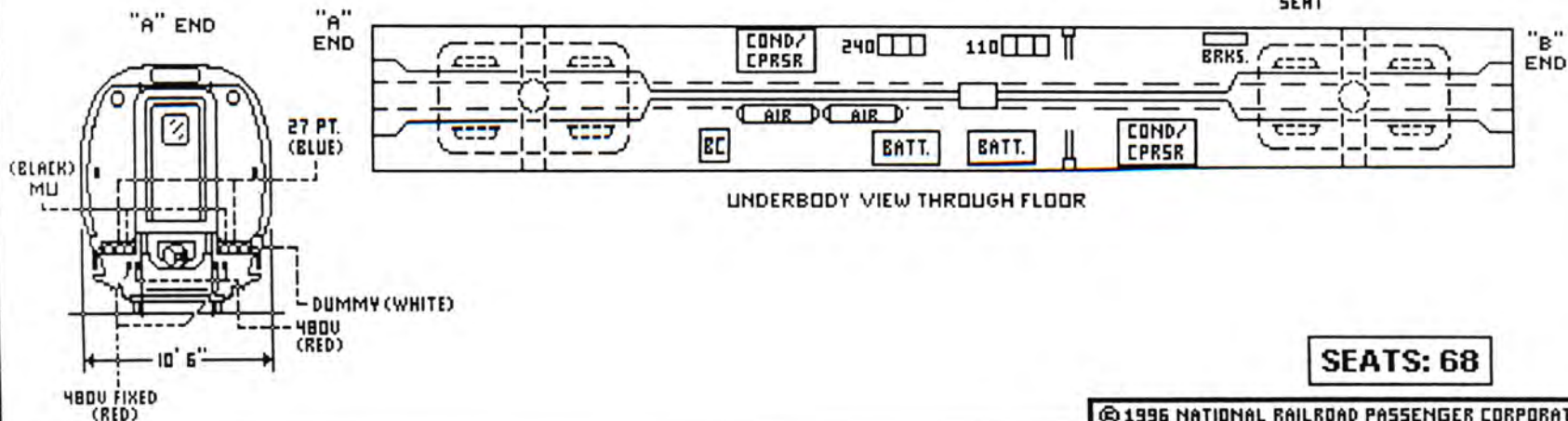
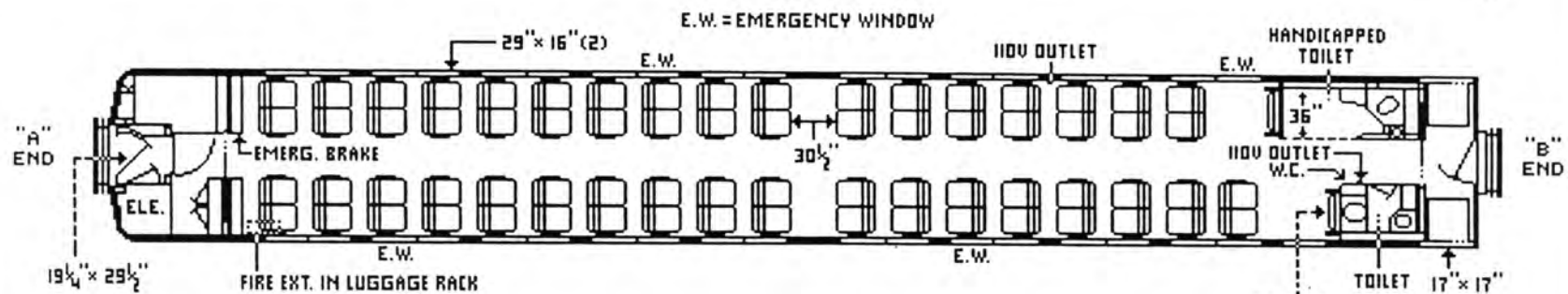
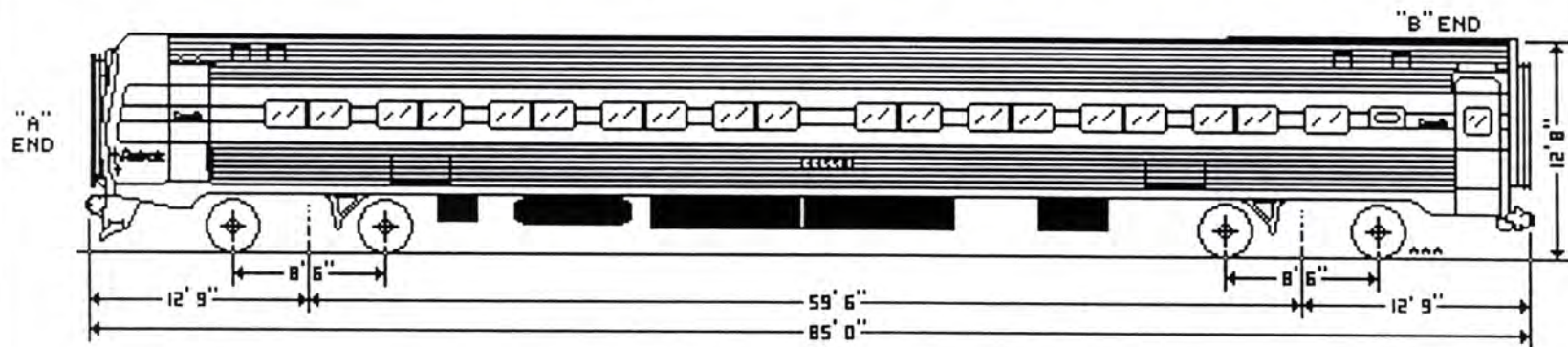

SEATS: 68

MICHIGAN PUSH-PULL COACH

Equipment Code: AM

125 MPH

Car Nos: 44552-44557

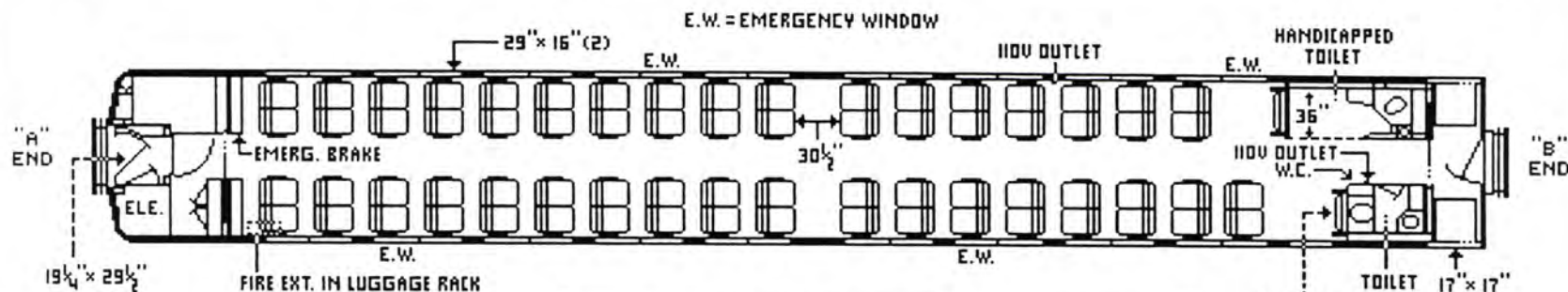
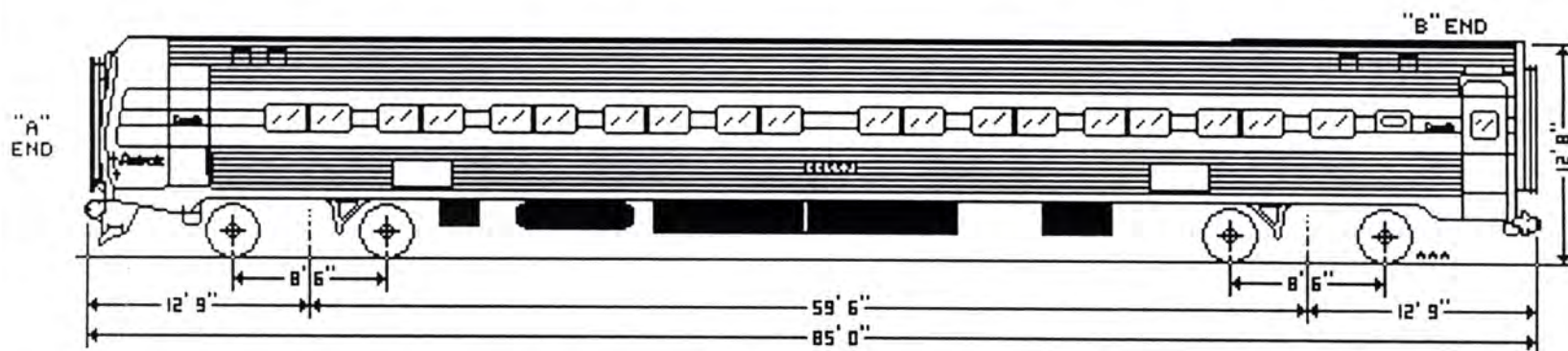

44553: SOME SEATS REMOVED. WELL-SUITED TO HANDICAP MOVES.

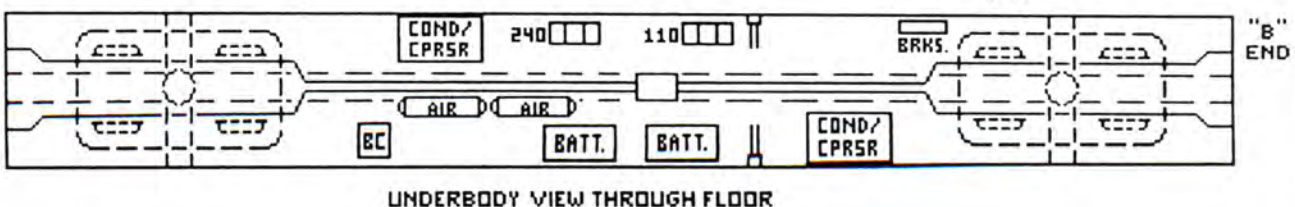
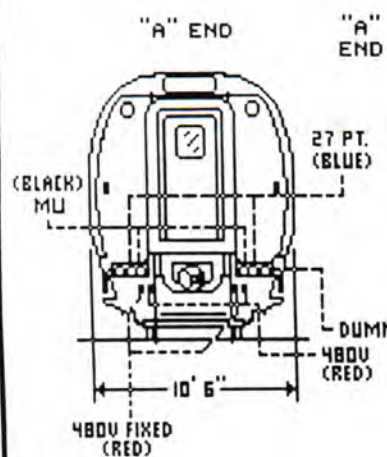

SEATS: 60

METROLINER AMFLEET COACH (HANDICAPPED)

Eqpt. Code: MC

125 MPH

Car Nos: 44700-44788

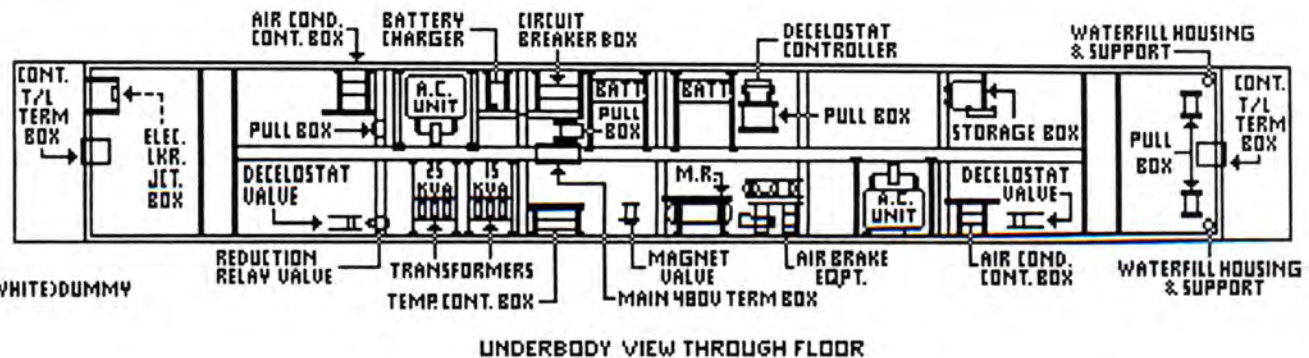
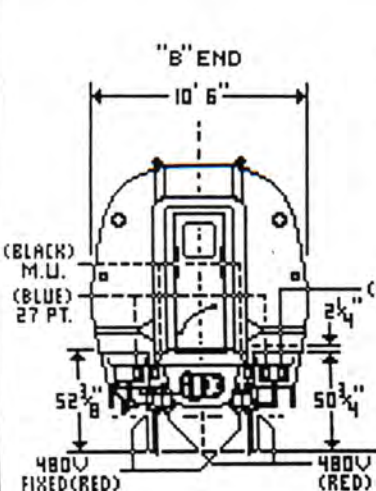
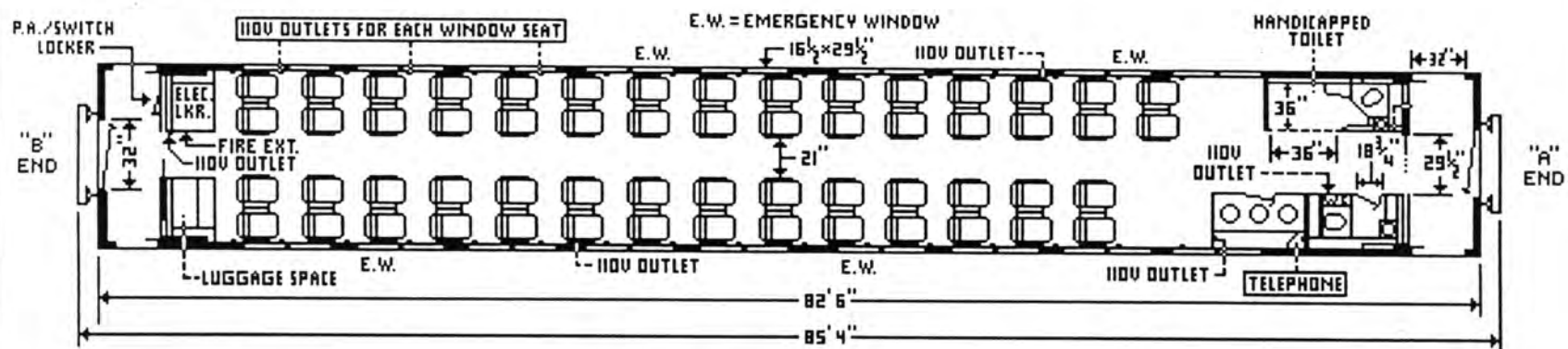
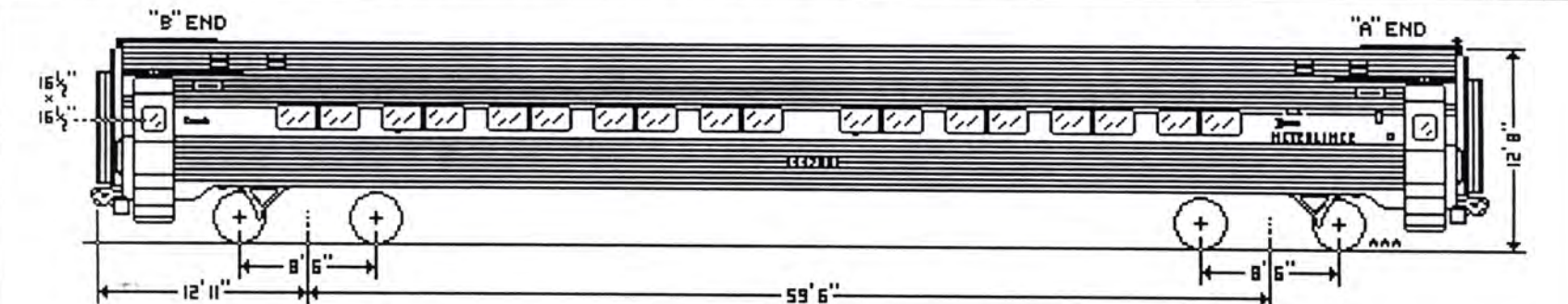

* INCLUDES A.D.A. MODIFICATIONS *

SEATS: 58

METROLINER AMFLEET COACH (HDCP)

Eqpt. Code: MC

125 MPH

Car Number: 44714

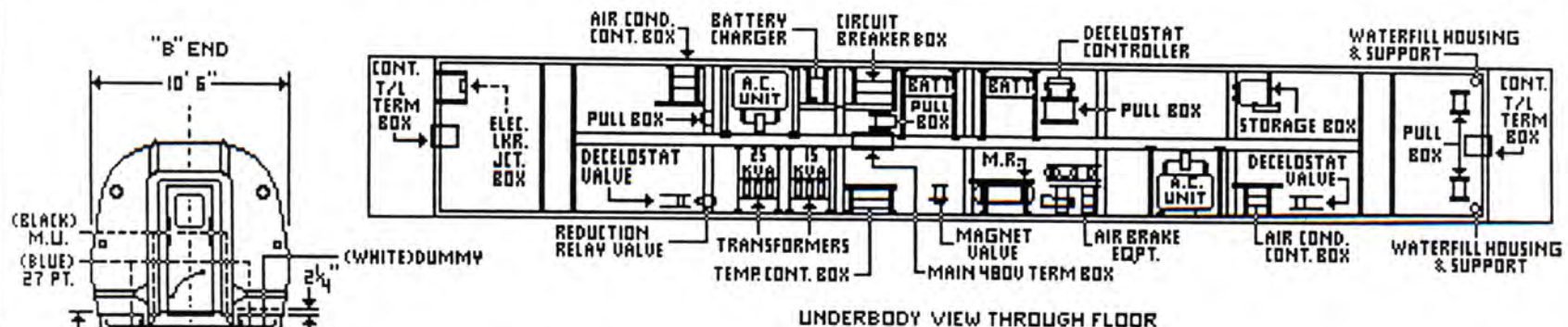
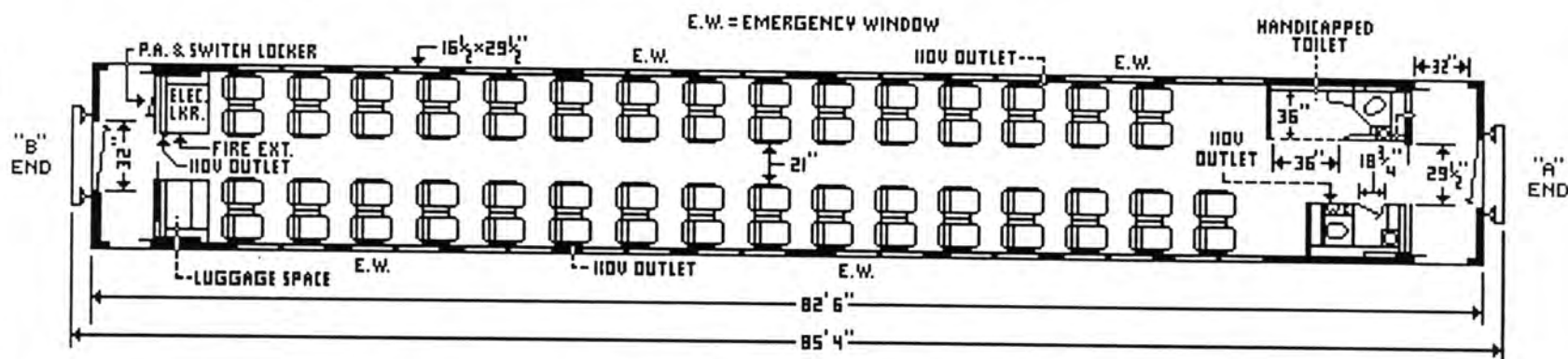
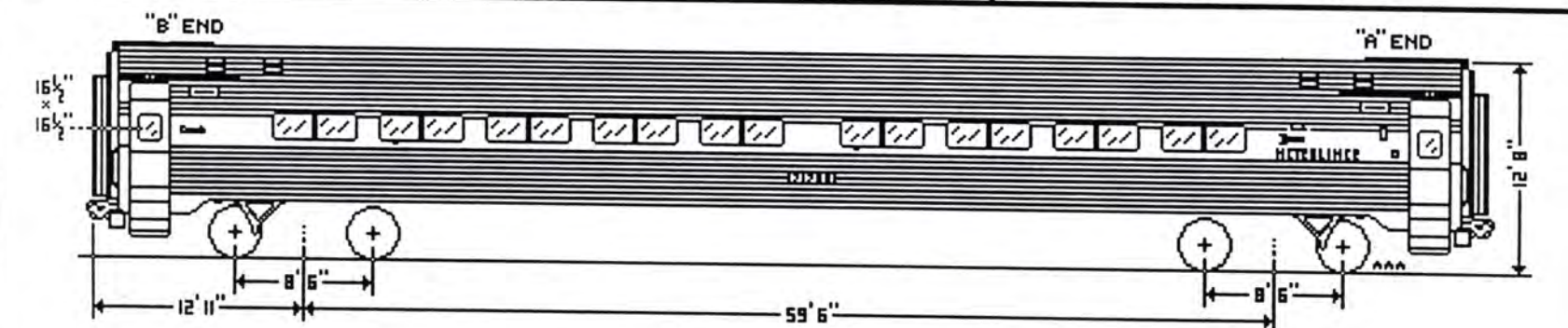

UNDERBODY VIEW THROUGH FLOOR

SEATS: 62

AMFLEET-I CUSTOM CLASS COACH(HDCP)

Eqpt. Code: MN

125 MPH

Car Nos: 44789-44790

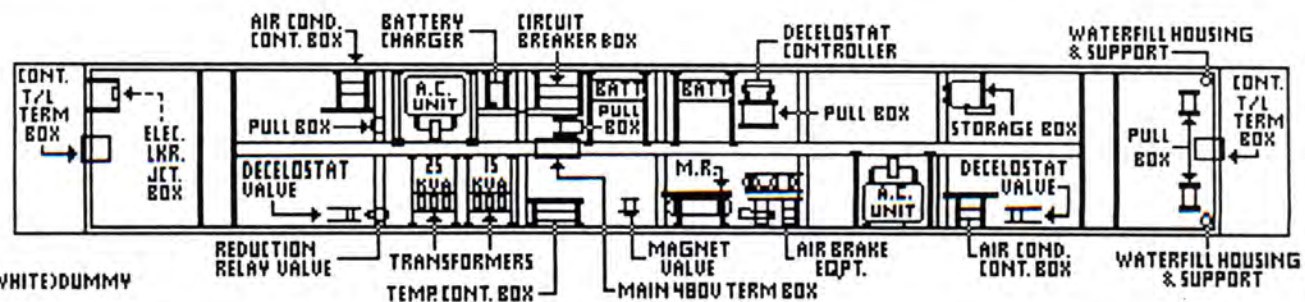
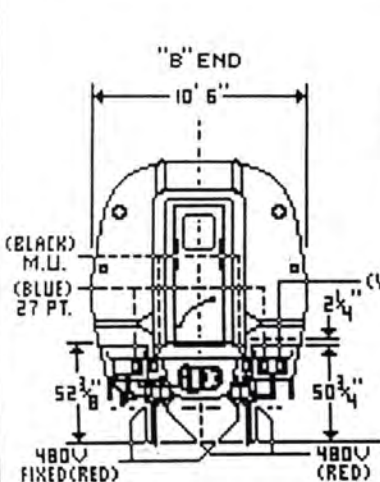
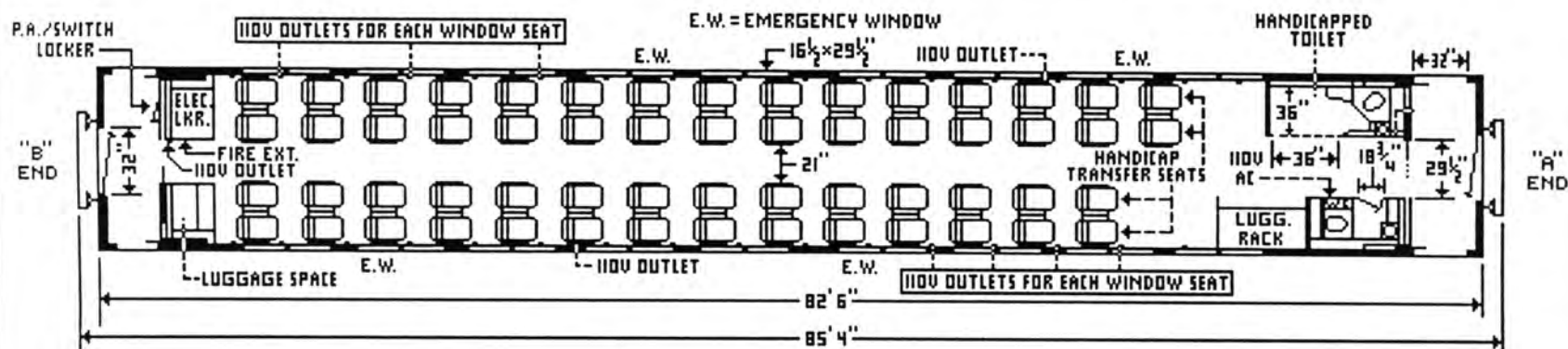
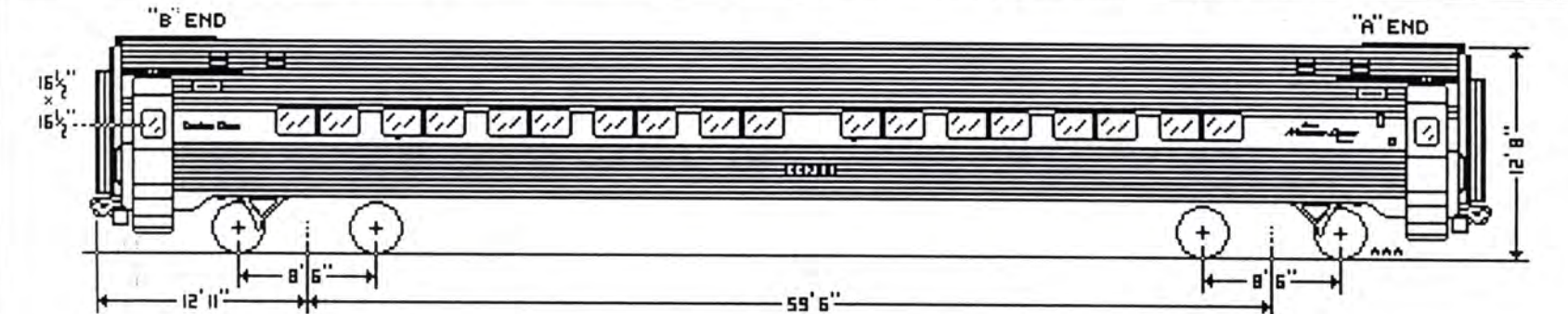

UNDERBODY VIEW THROUGH FLOOR

* INCLUDES A.D.A. MODIFICATIONS *

SEATS: 58

AMFLEET-I CUSTOM CLASS COACH(HDCP)

Eqpt. Code: MN

125 MPH

Car Nos: 44791

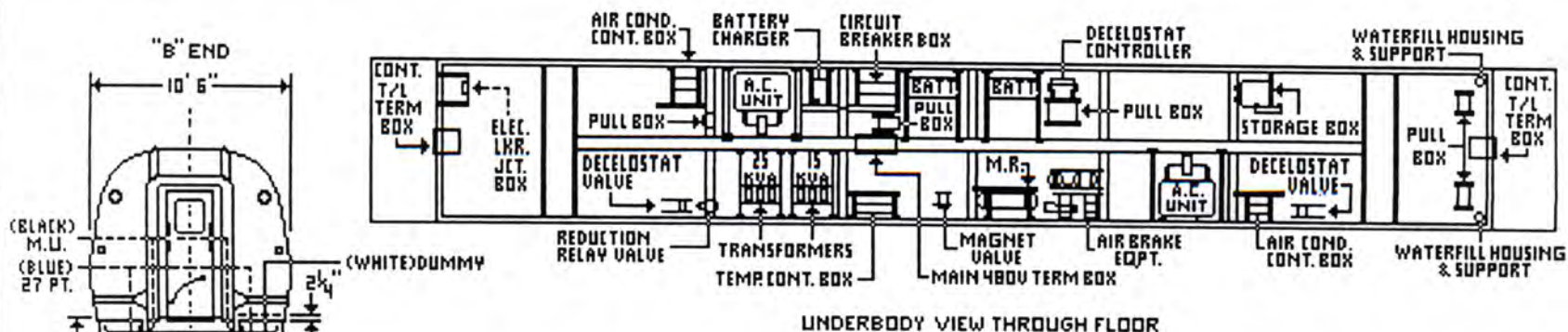
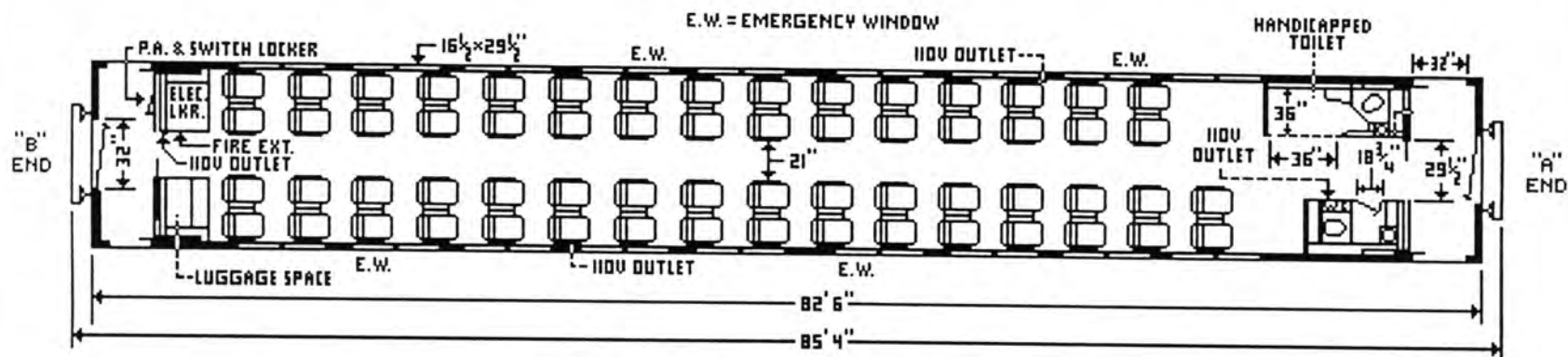
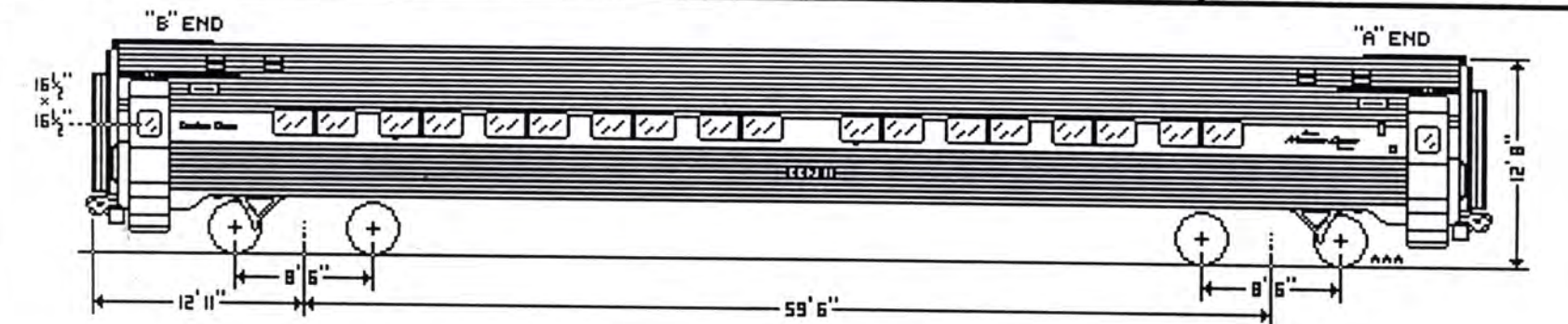

SEATS: 62

AMFLEET-I CUSTOM CLASS COACH(HDCP)

Eqpt. Code: MN

125 MPH

Car Nos: 44792-44799

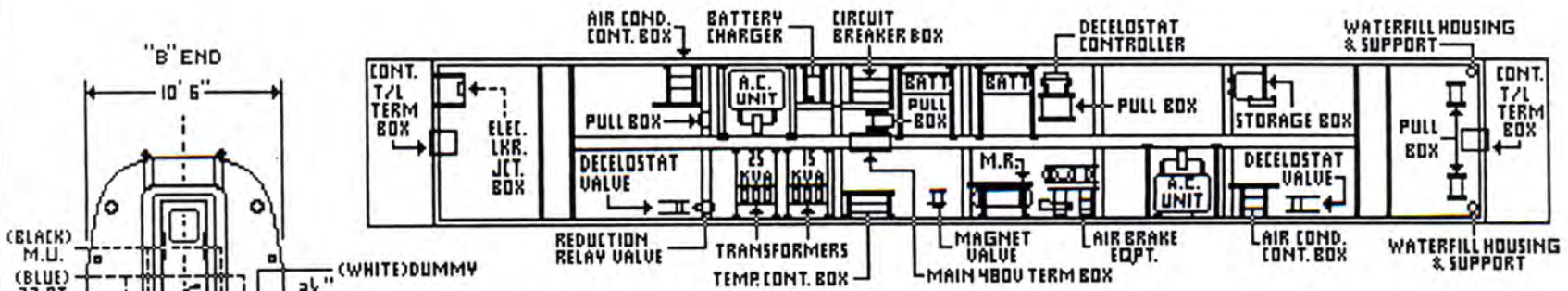
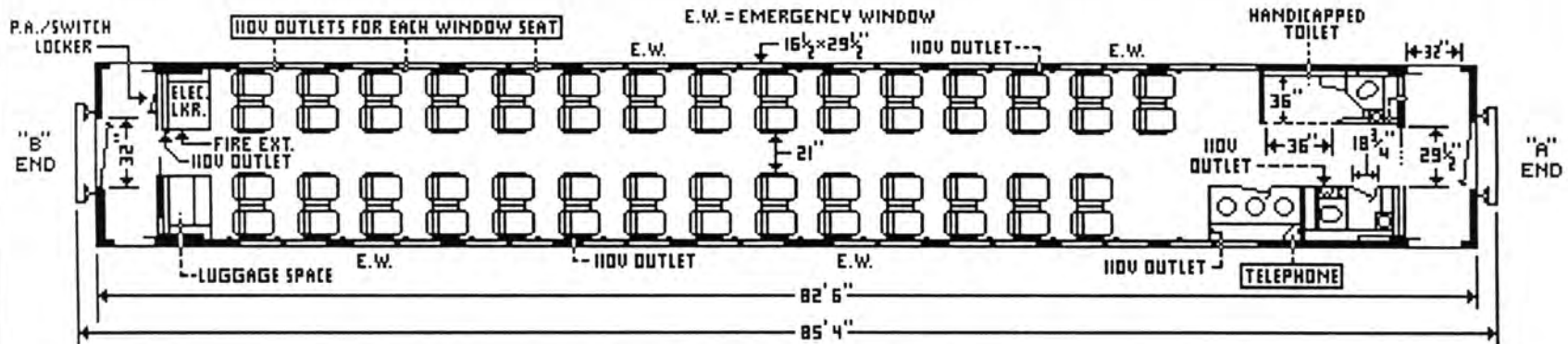
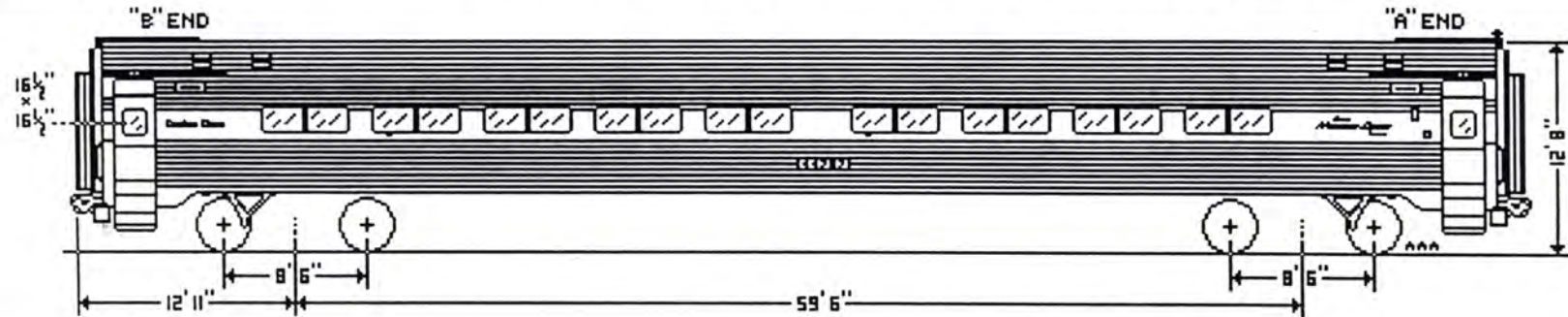

UNDERBODY VIEW THROUGH FLOOR

* INCLUDES A.D.A. MODIFICATIONS *

SEATS: 58

AMFLEET-I CUSTOM CLASS COACH

Eqpt. Code: AR

125 MPH

Car Numbers: 44805-44887

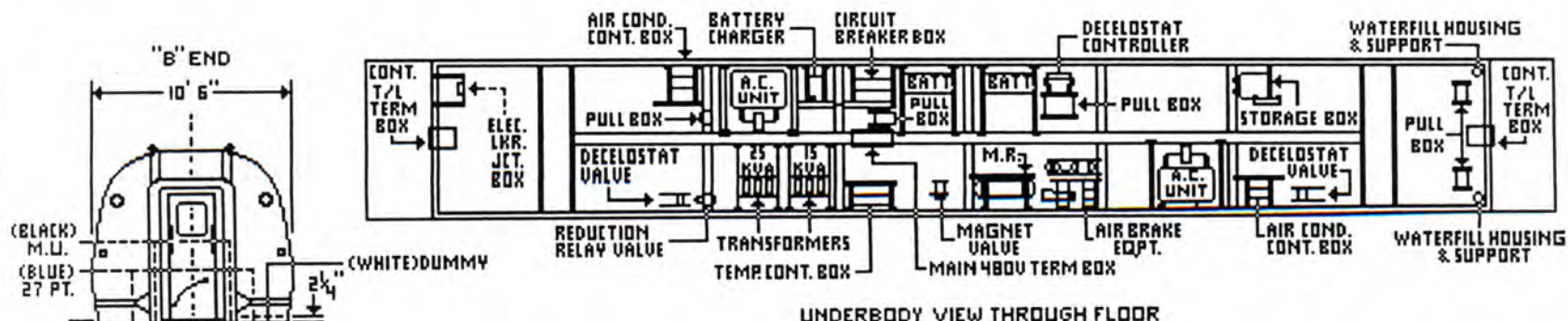
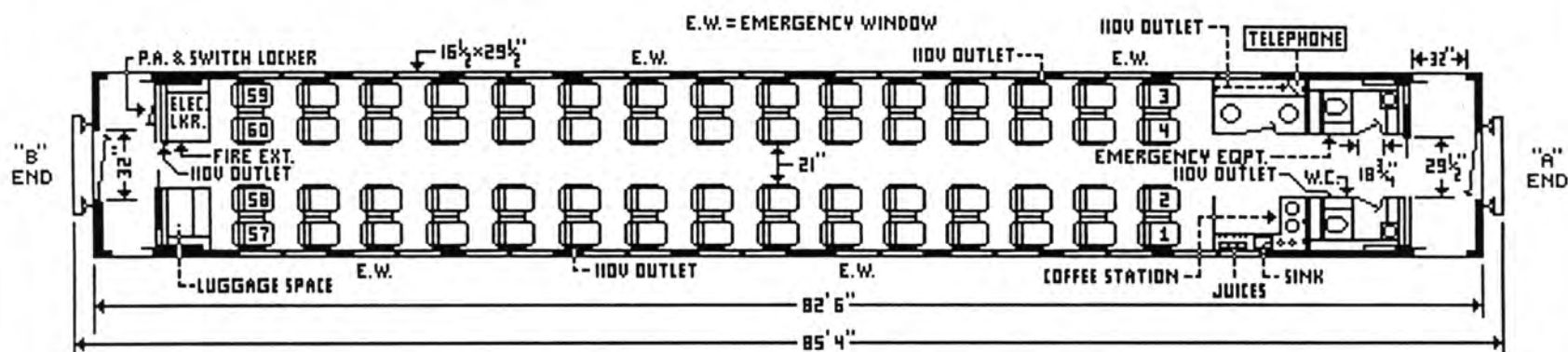
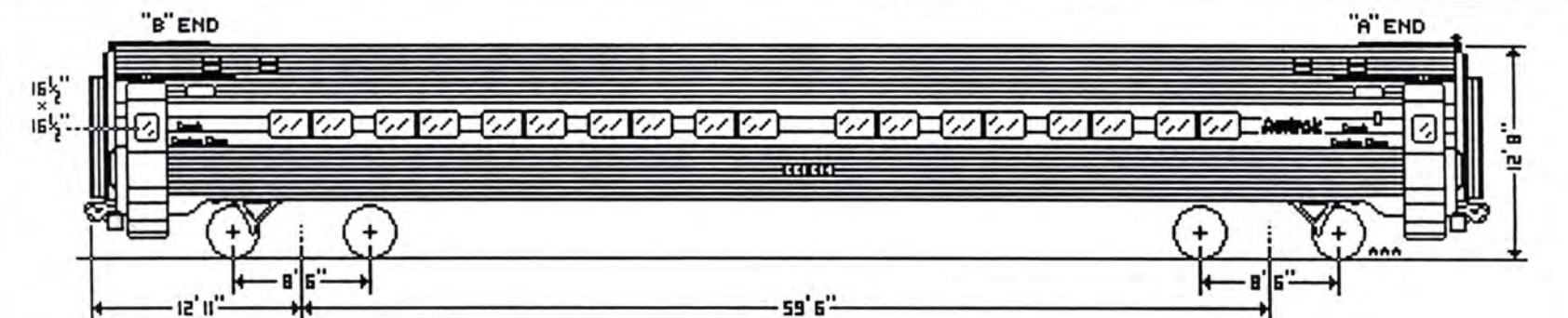

SEATS: 60

METROLINER AMFLEET COACH

Eqpt. Code: MC

125 MPH

Car Numbers: 44900-44986

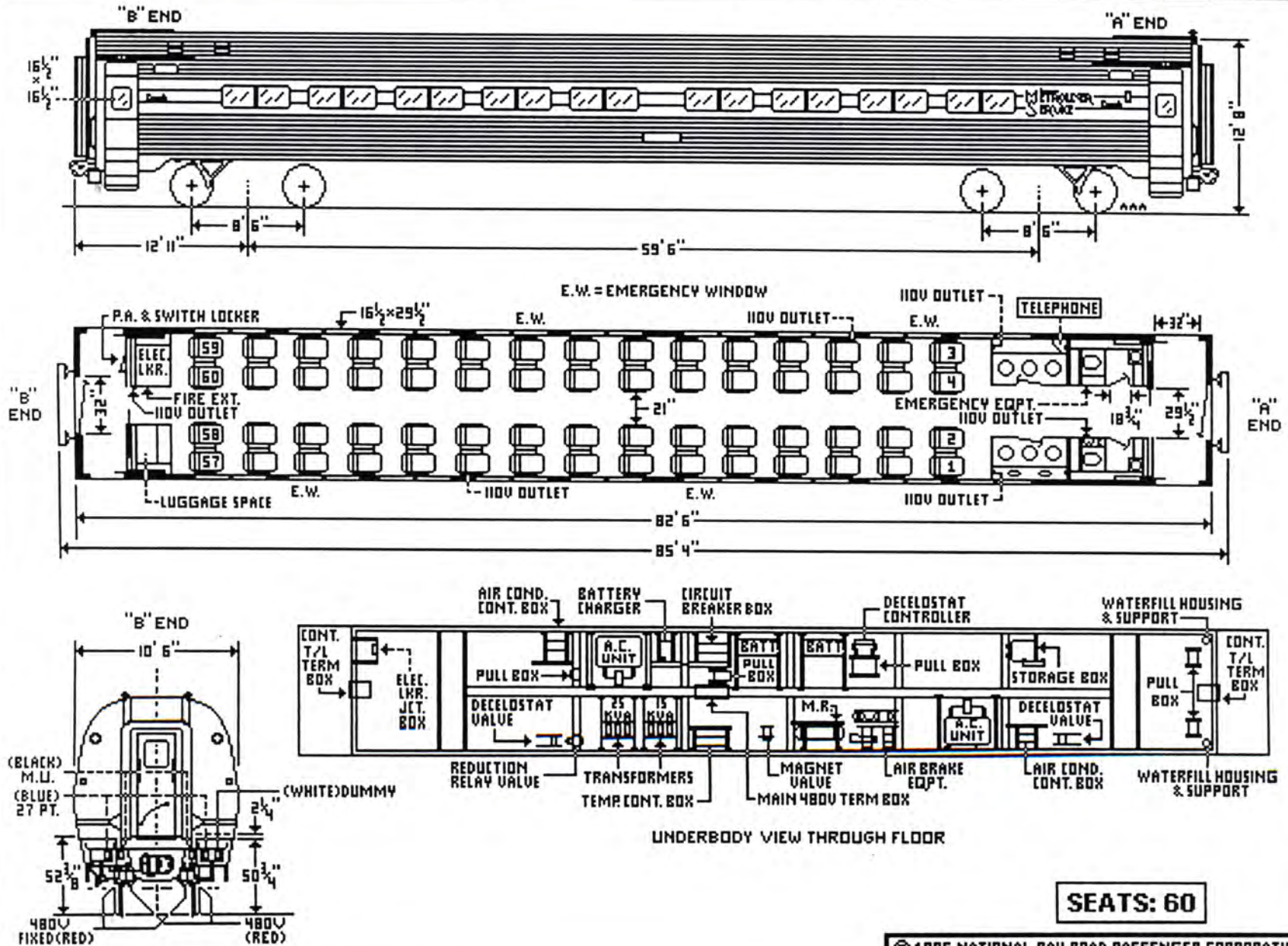

SEATS: 60

METROLINER AMFLEET COACH

Eqpt. Code: MC

125 MPH

Car Nos: 44906, 13, 17, 19, 20, 90

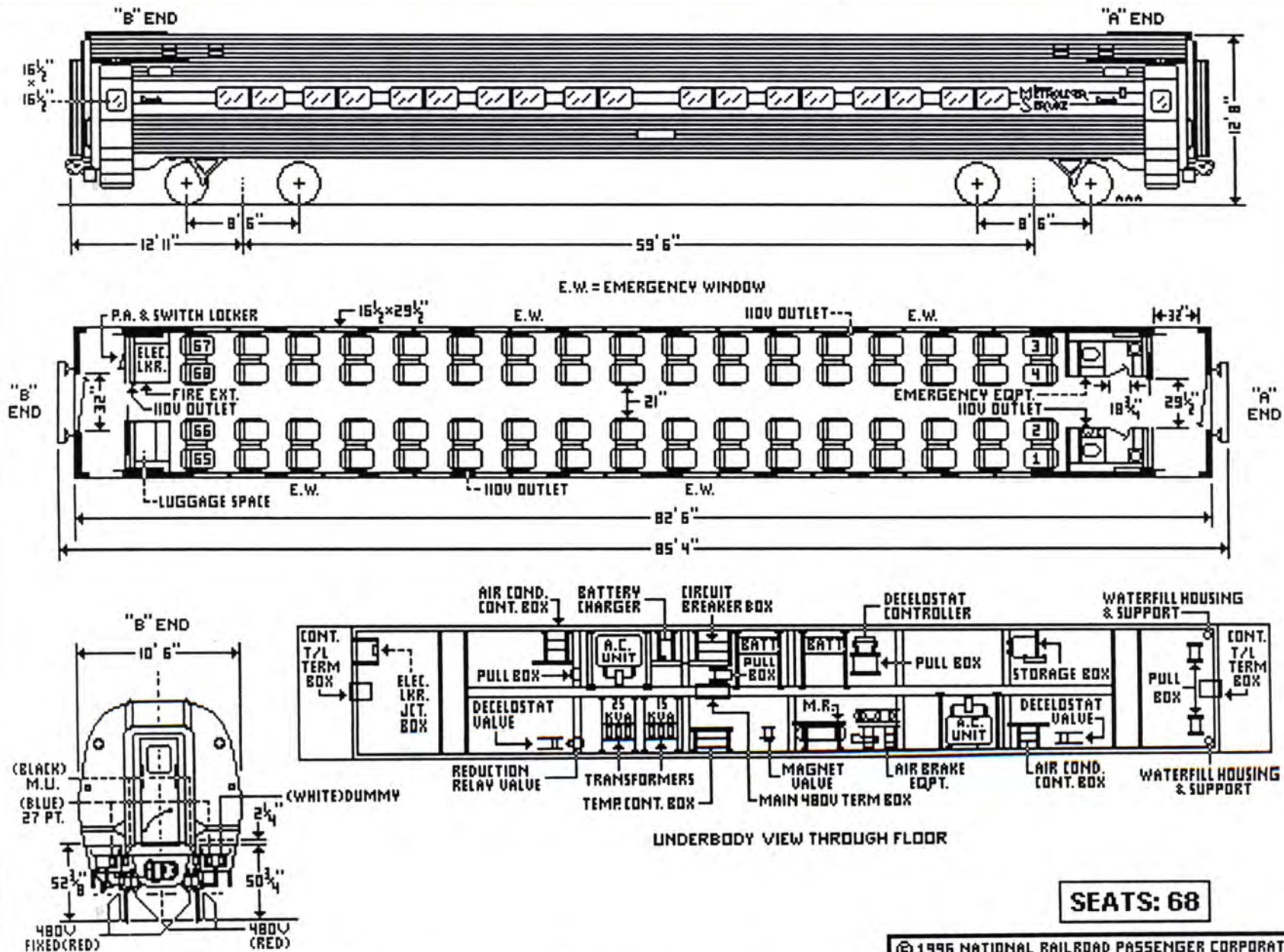

METROLINER AMFLEET COACH

Eqpt. Code: MC

125 MPH

Car Numbers: 44923, 53, 67, 80

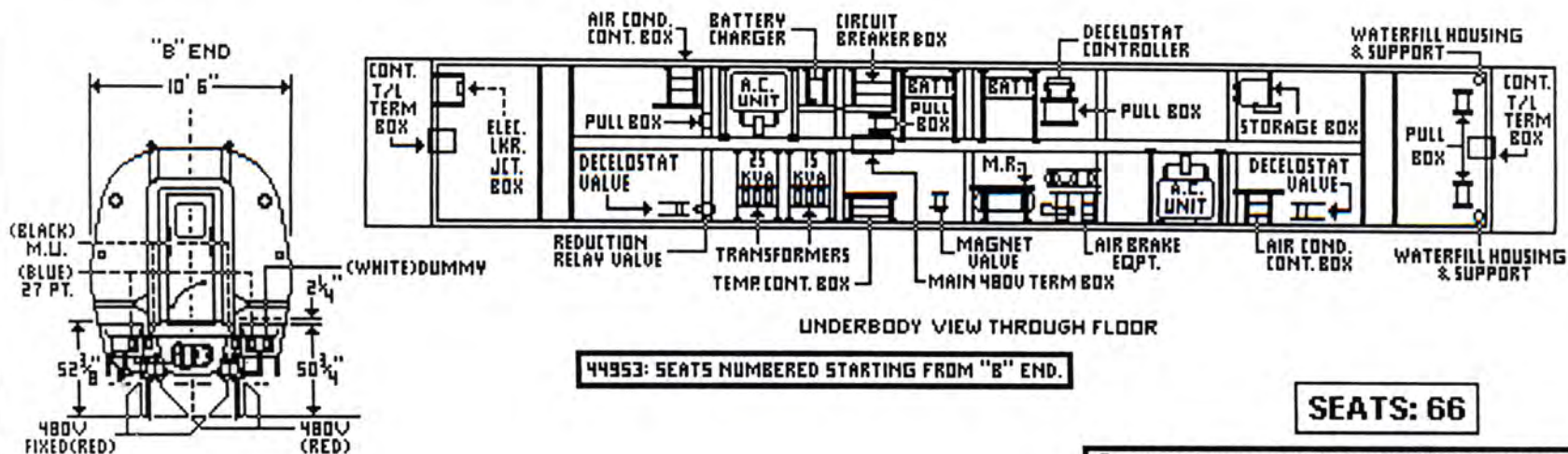
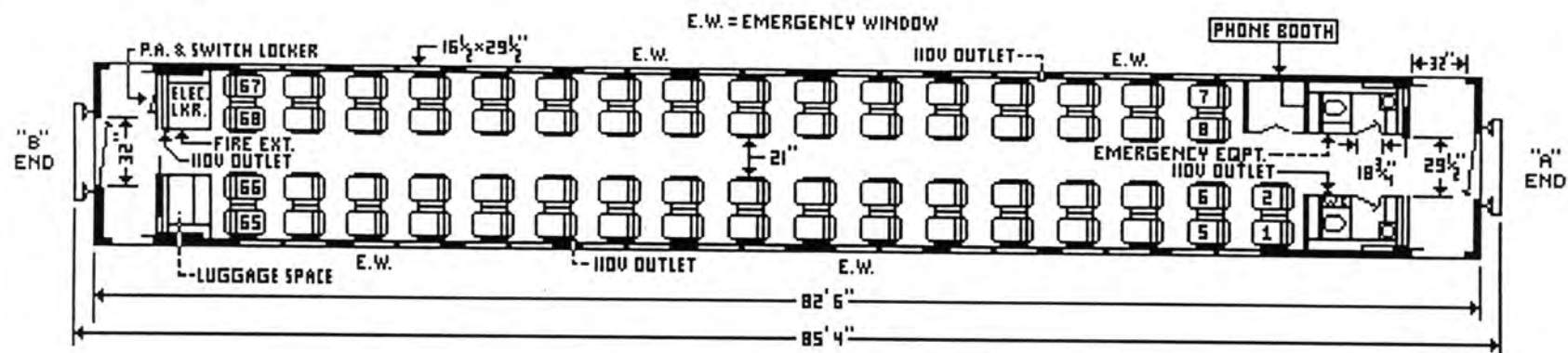
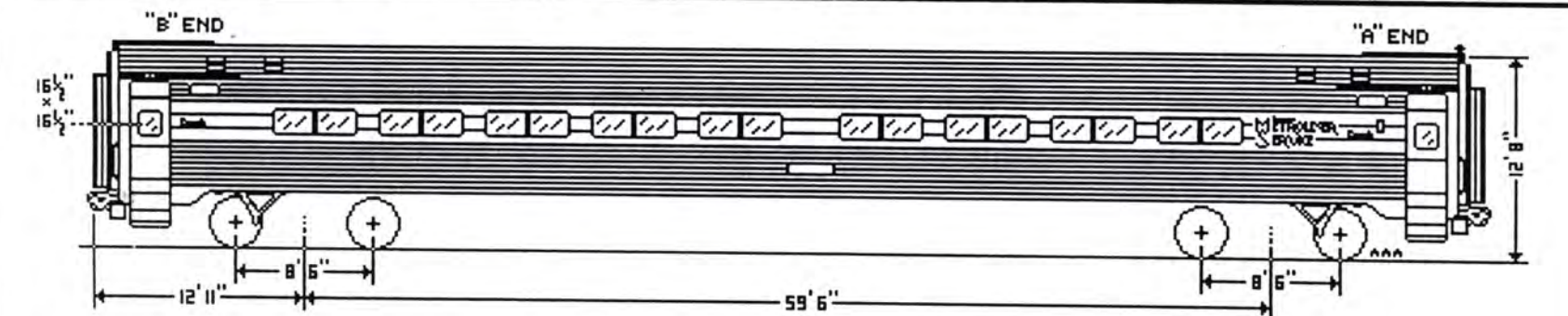

AMFLEET-I CUSTOM CLASS COACH

Eqpt. Code: MN

125 MPH

Car Nos: 44927-44943, 44949, 44951

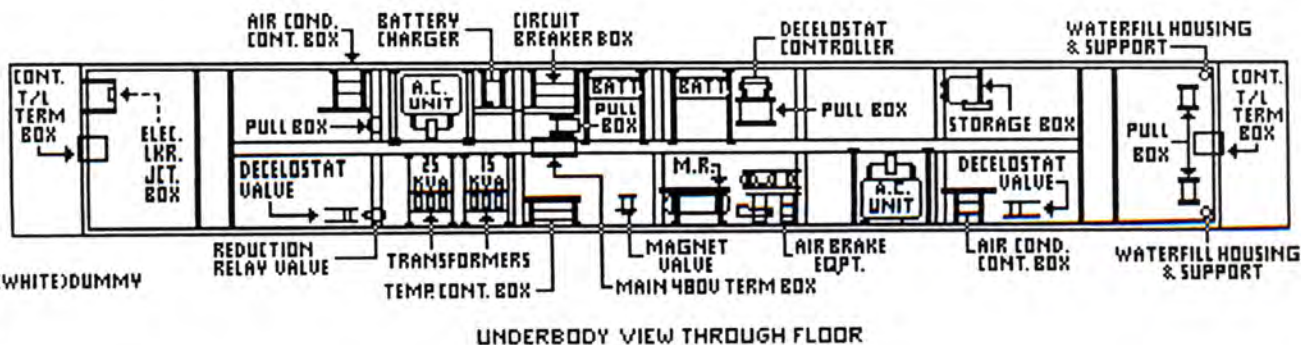
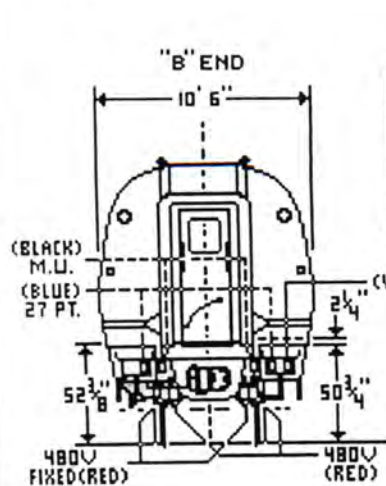
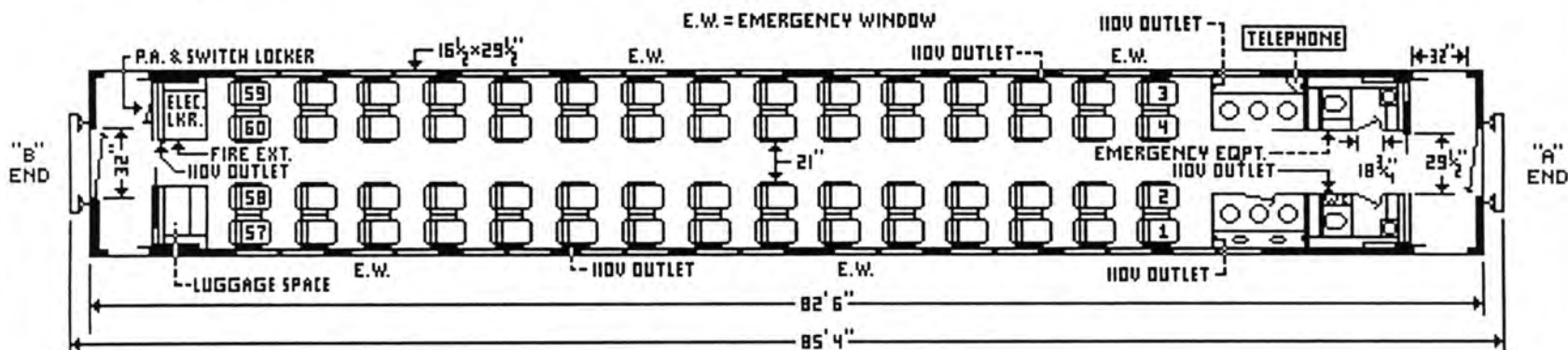
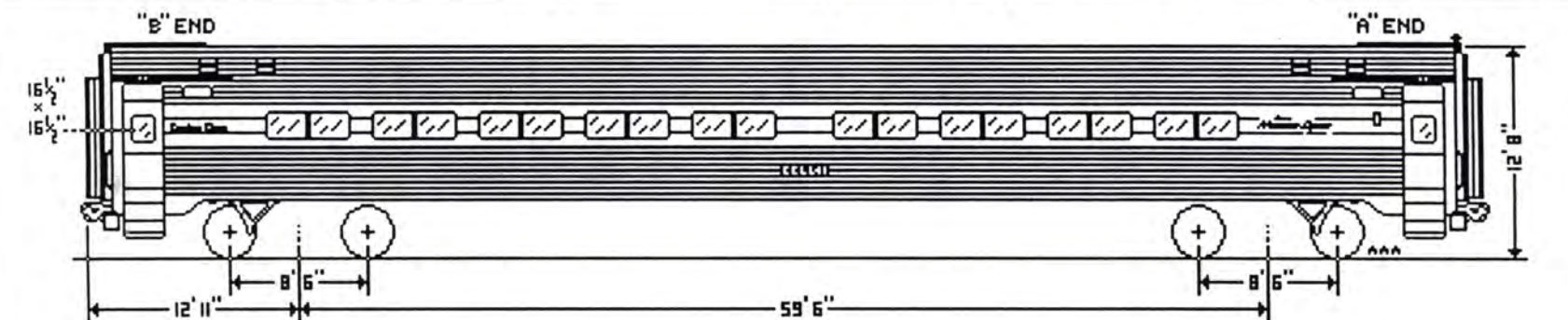

SEATS: 60

AMFLEET-I CLUB-DINETTE

Equipment Code: CD

125 MPH

Car Numbers: 48150-48159

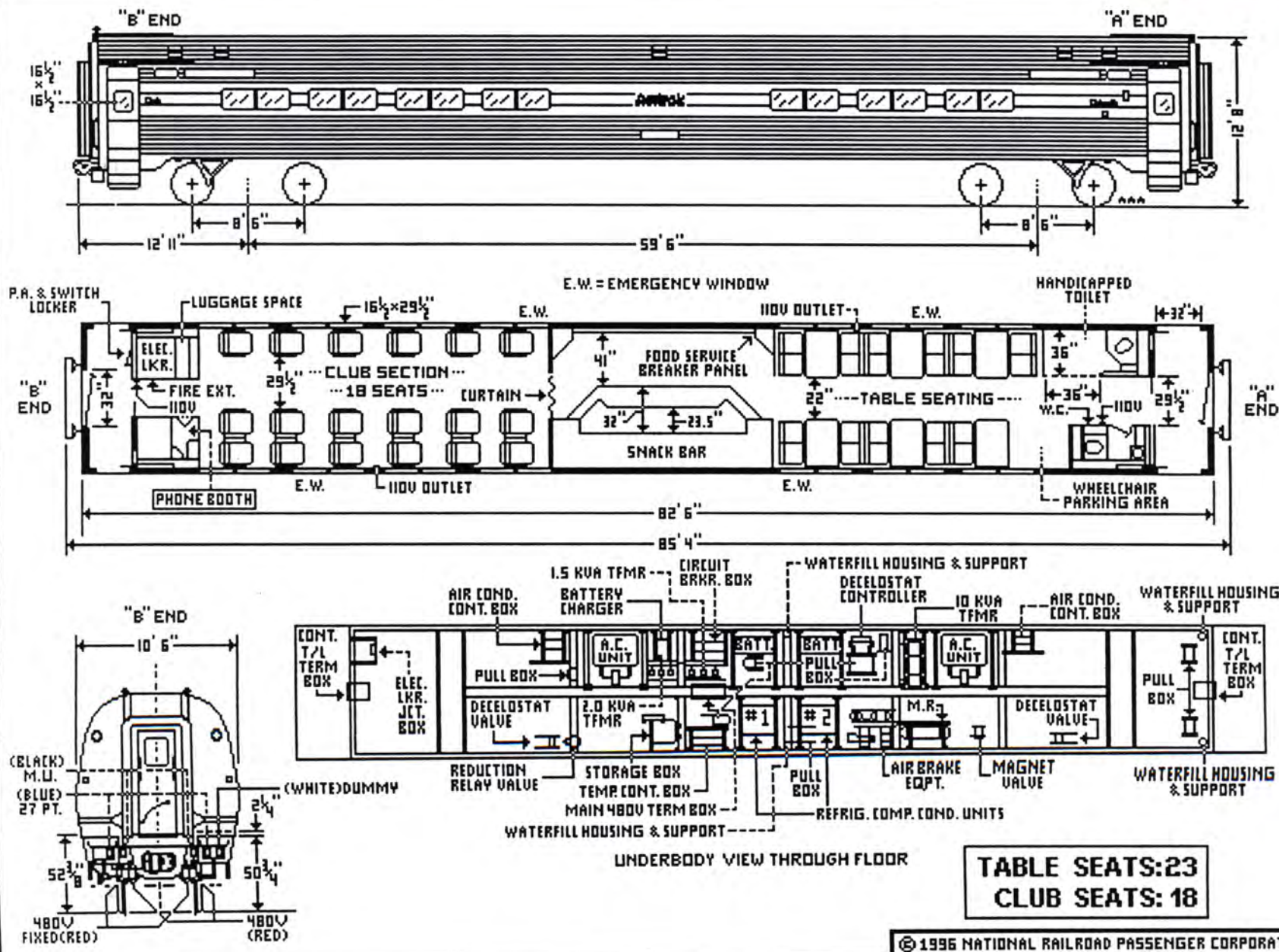

AMFLEET-I CLUB-DINETTE

Equipment Code: CD

125 MPH

Car Numbers: 48150-48159

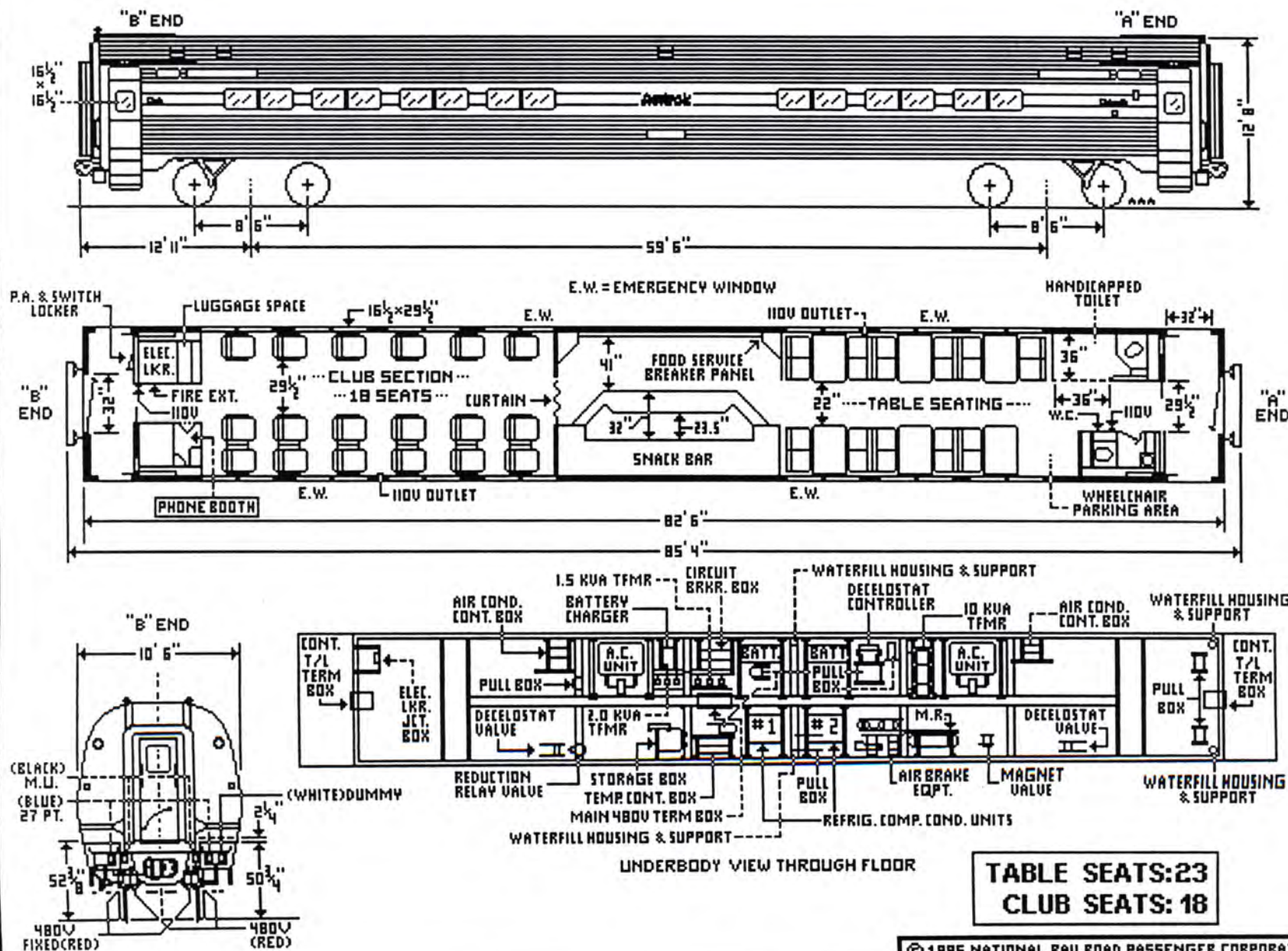

**TABLE SEATS: 23
CLUB SEATS: 18**

AMFLEET-I DINETTE

Equipment Code: AD

125 MPH

Car Numbers: 48201-48241

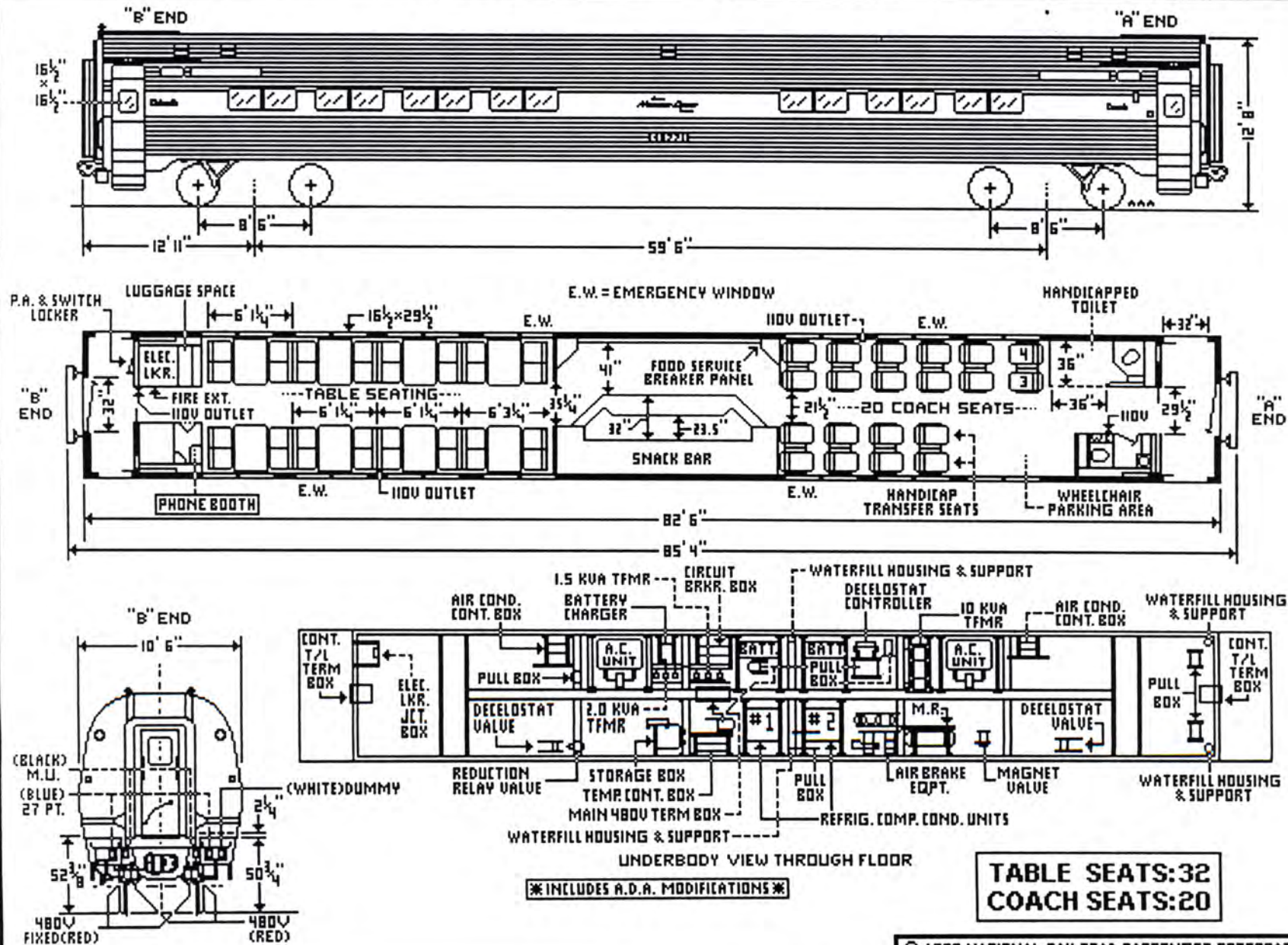

AMFLEET-I FULL CLUB

Eqpt. Code: AP

125 MPH

Car Nos: 48978,48980,48981,48984-48985

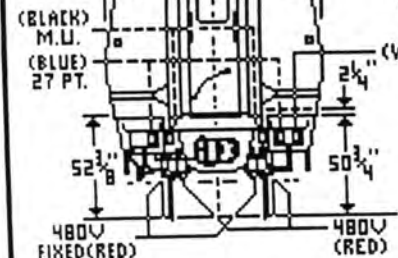
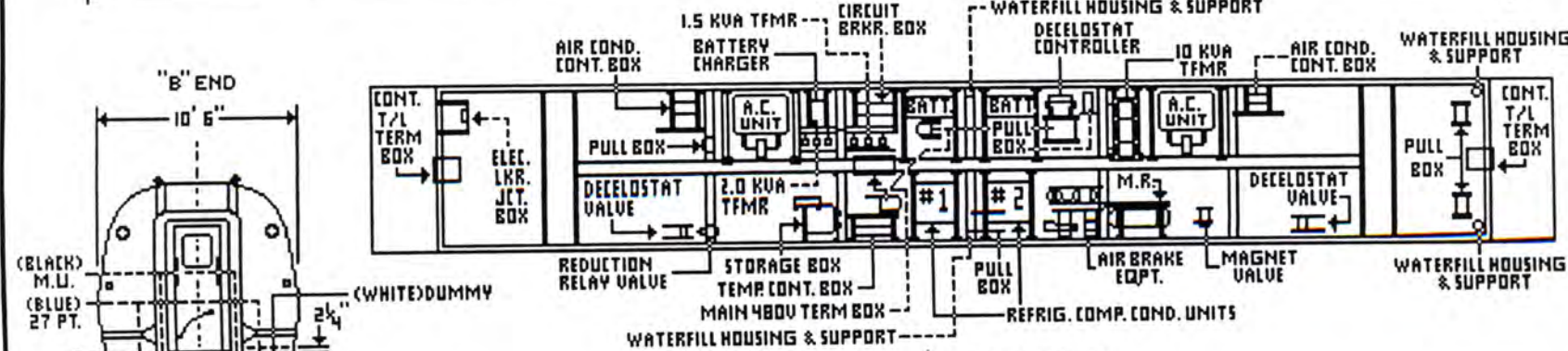
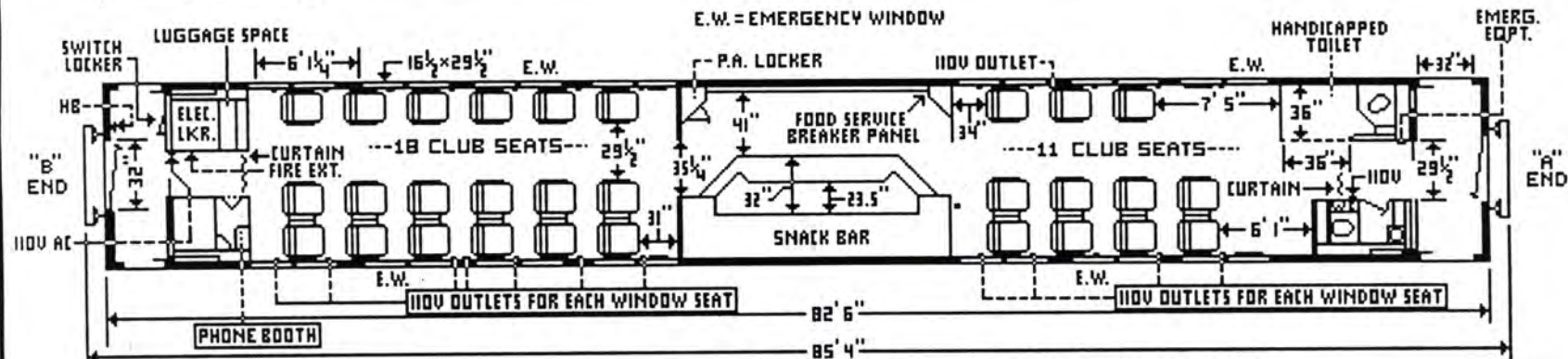
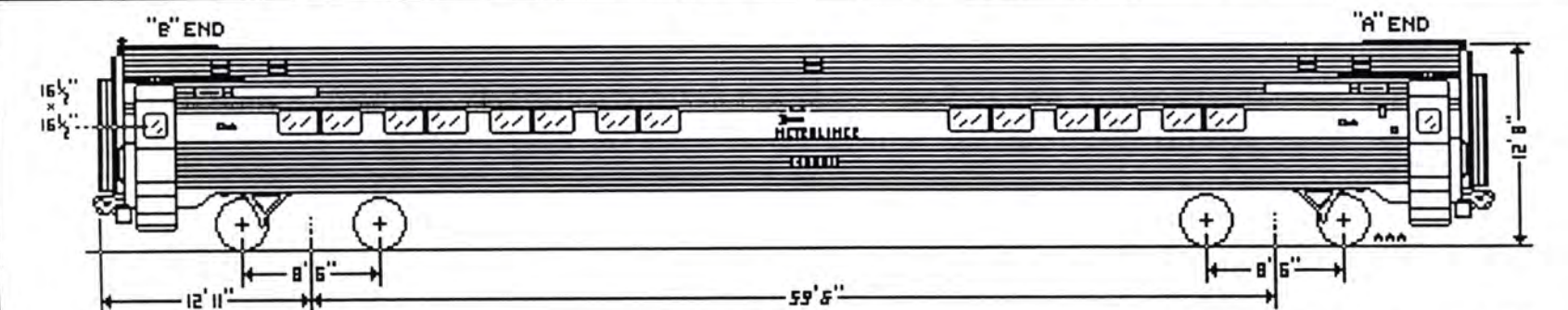

UNDERBODY VIEW THROUGH FLOOR
 * INCLUDES A.D.A. MODIFICATIONS *

CLUB SEATS: 29

AMFLEET-I FULL CLUB

Equipment Code: AP

125 MPH

Car Numbers: 48986-48992

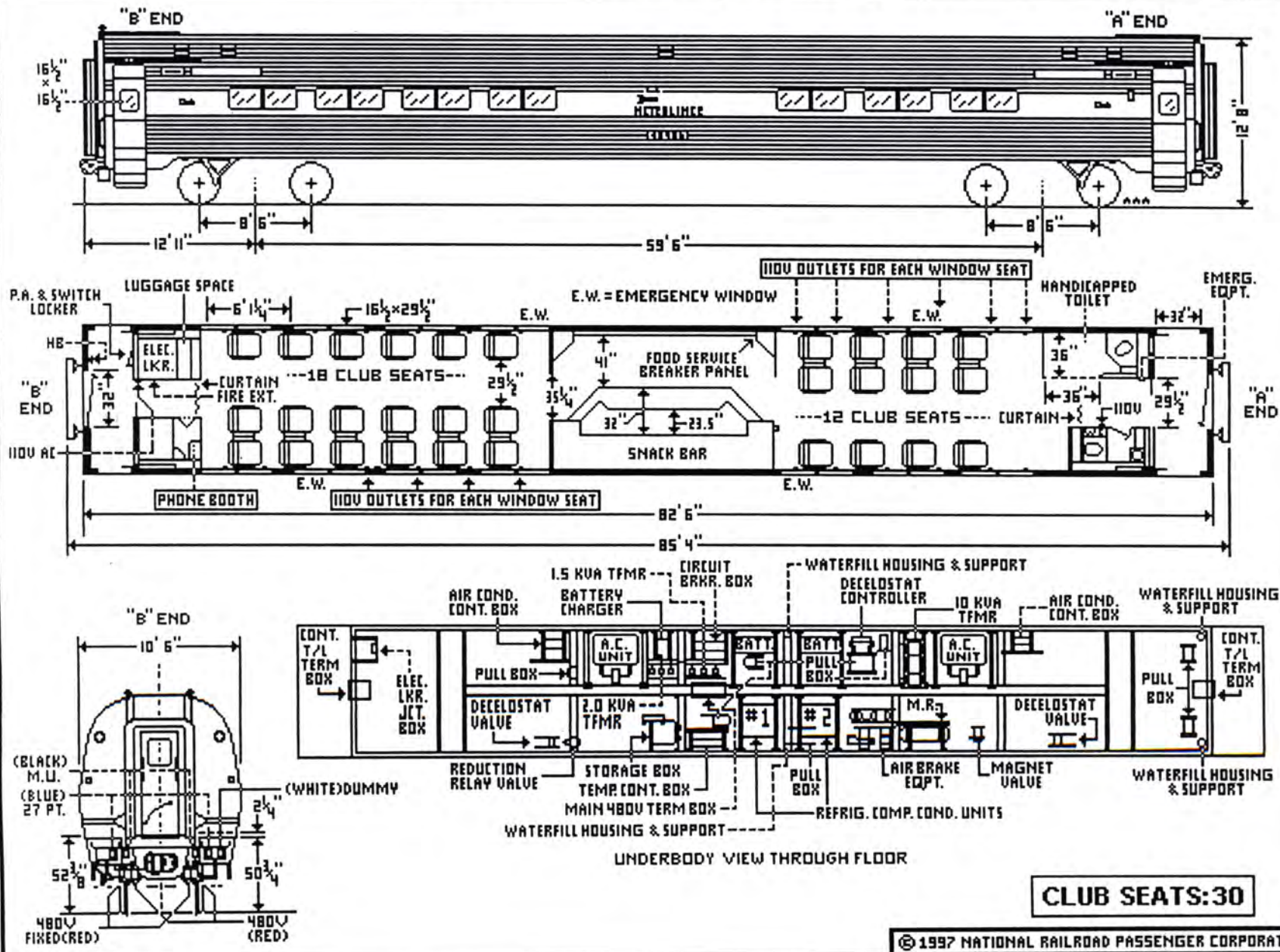

HORIZON FLEET HALF DINETTE

Equipment Code: HF

125 MPH

Car Nos: 53000-53007

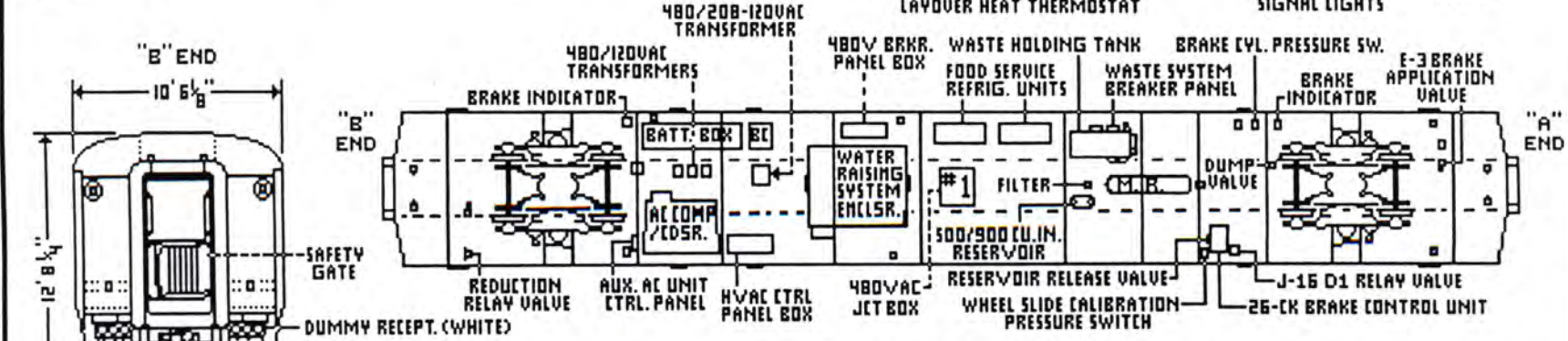
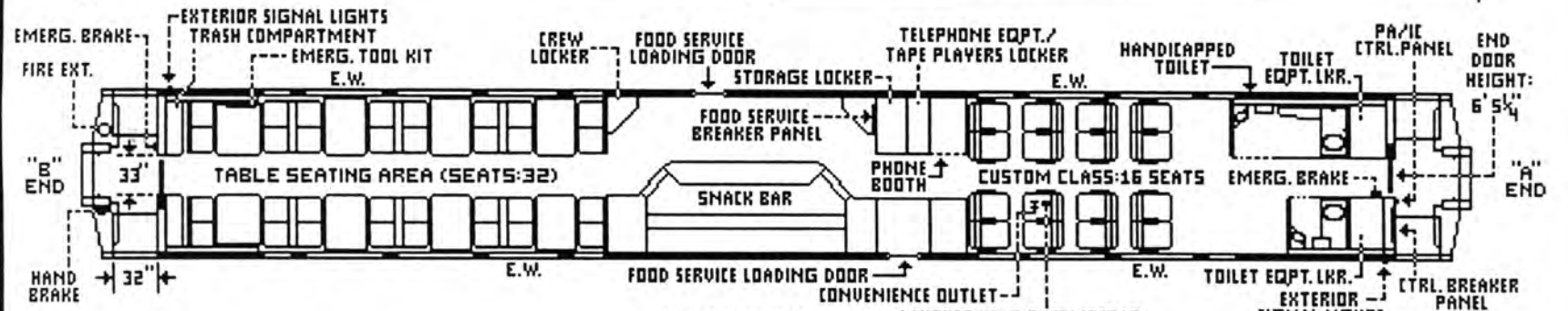
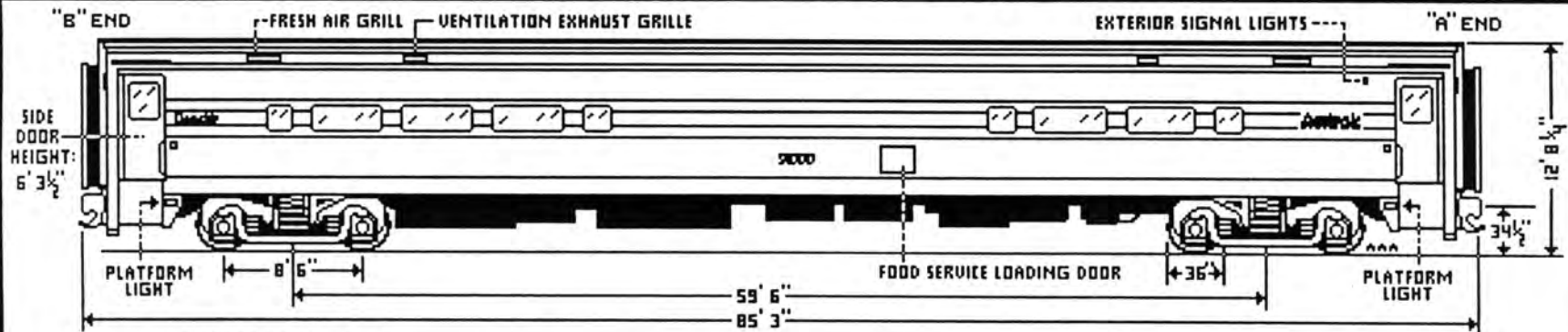

UNDERBODY VIEW THROUGH FLOOR

✱ INCLUDES A.D.A. MODIFICATIONS ✱

**TABLE SEATS: 32
CUSTOM CLASS: 16**

CONTINUITY RECEPT.(WHITE) FIXED 480V CABLE & RECEPT.(2)(RED)

HORIZON FLEET FULL DINETTE

Equipment Code: HF

125 MPH

Car Nos: 53500-53509

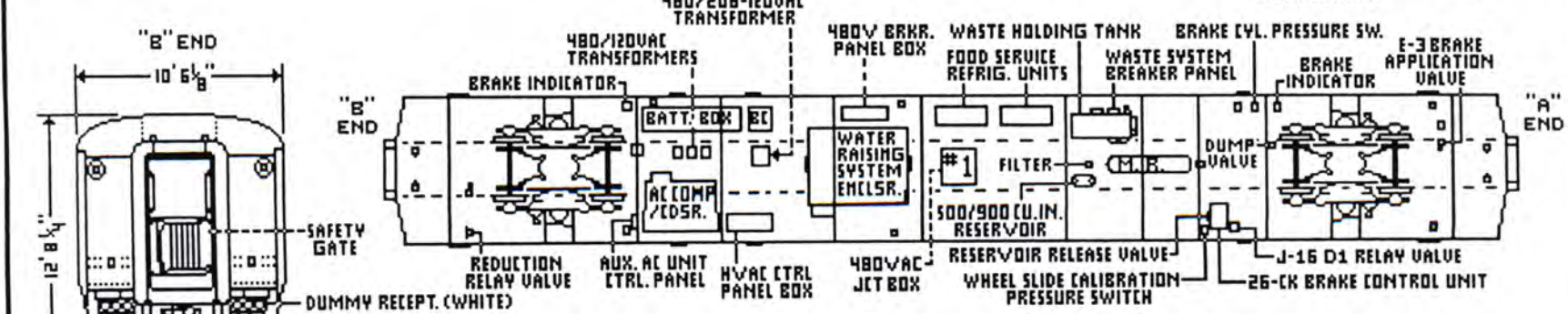
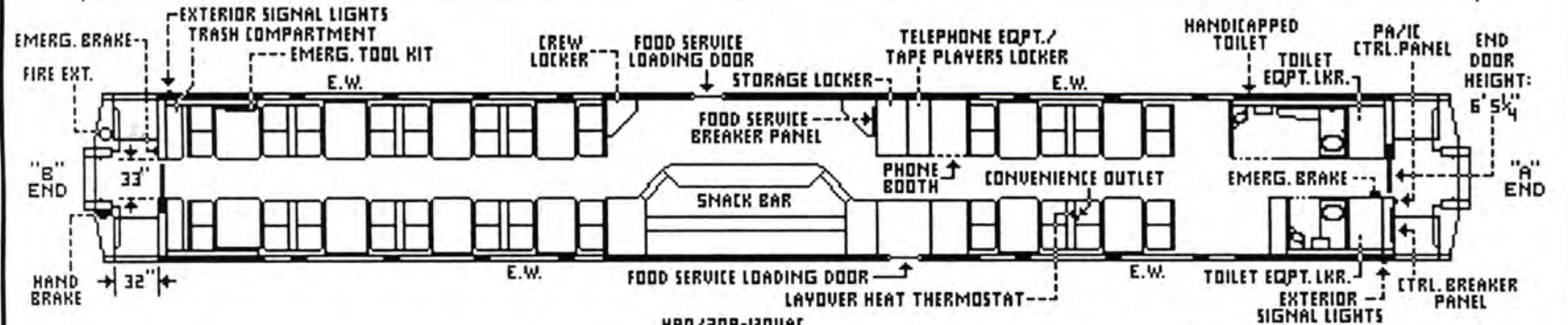
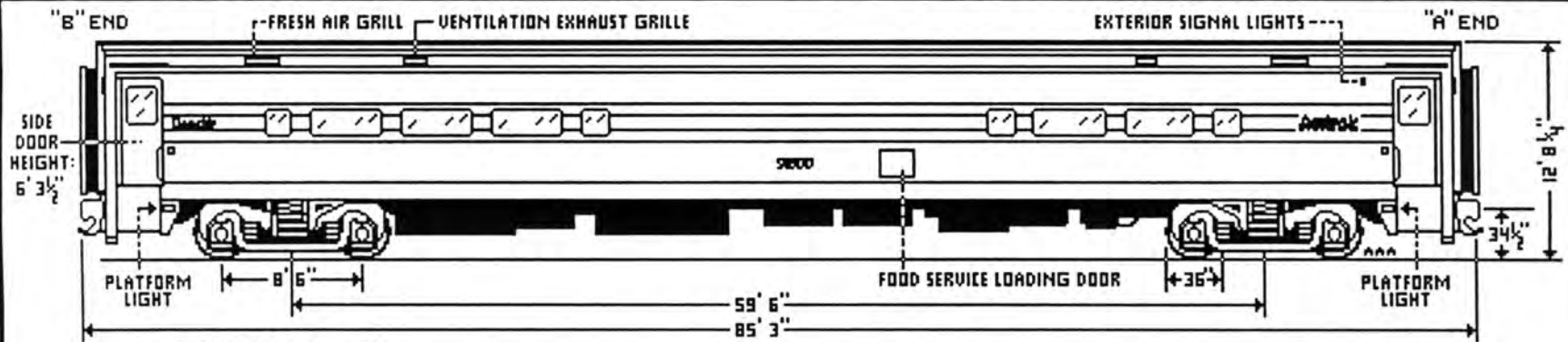

UNDERBODY VIEW THROUGH FLOOR

* INCLUDES A.D.A. MODIFICATIONS *

TABLE SEATS: 48

CONTINUITY RECEPT.(WHITE) FIXED 480V CABLE & RECEPT.(2)(RED)

DOOR CTRL/COMM RECEPT.(2)(BLUE)

HORIZON FLEET COACH

Equipment Code: HO

125 MPH

Car Nos: 54000-54043

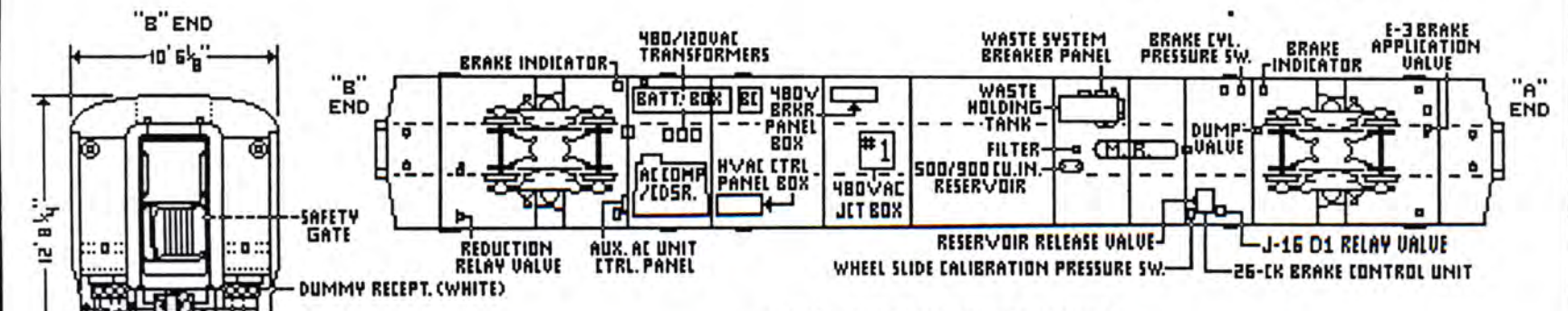
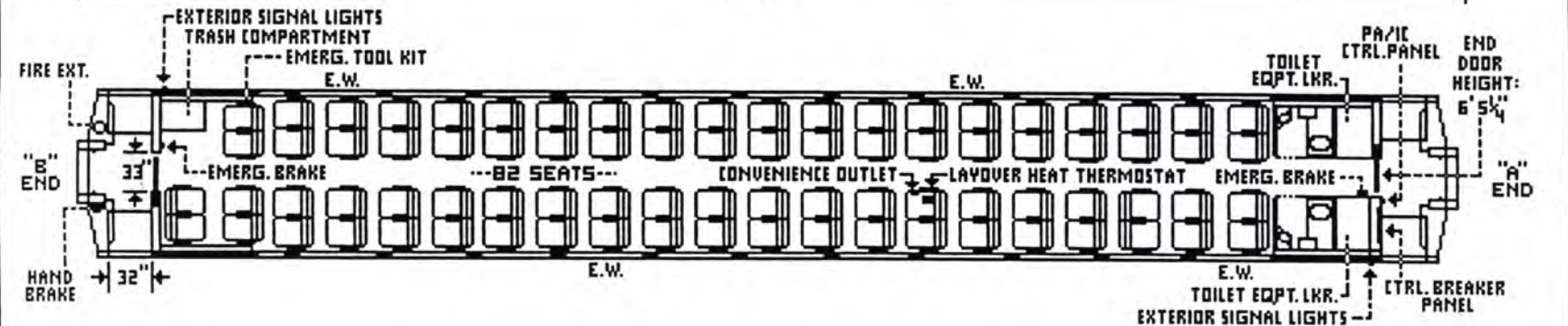
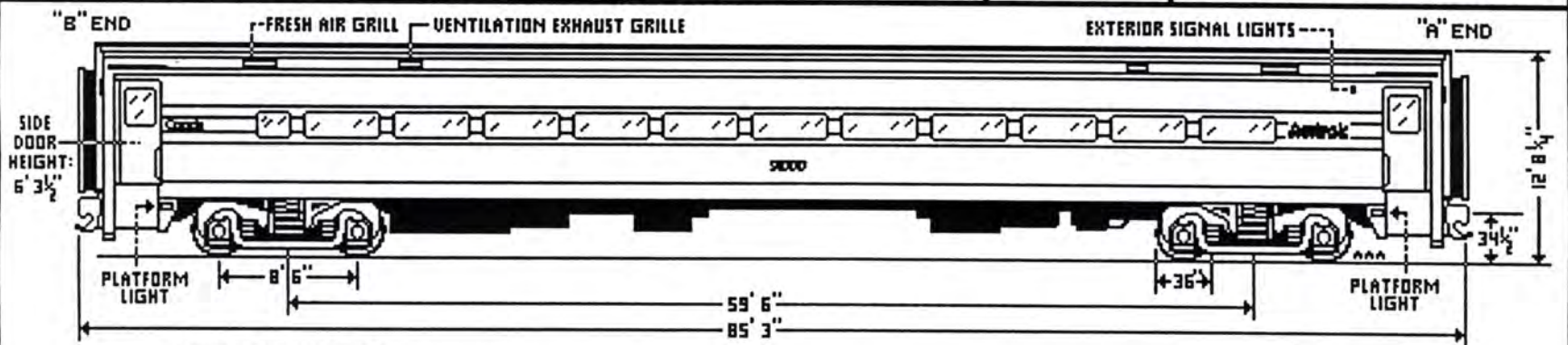

CONTINUITY RECEPT. (WHITE) FIXED 480V CABLE & RECEPT. (2) (RED)

DOOR CTRL./COMM RECEPT. (2) (BLUE)

SEATS: 82

HORIZON FLEET COACH

Equipment Code: HO

125 MPH

Car Nos: 54044-54071

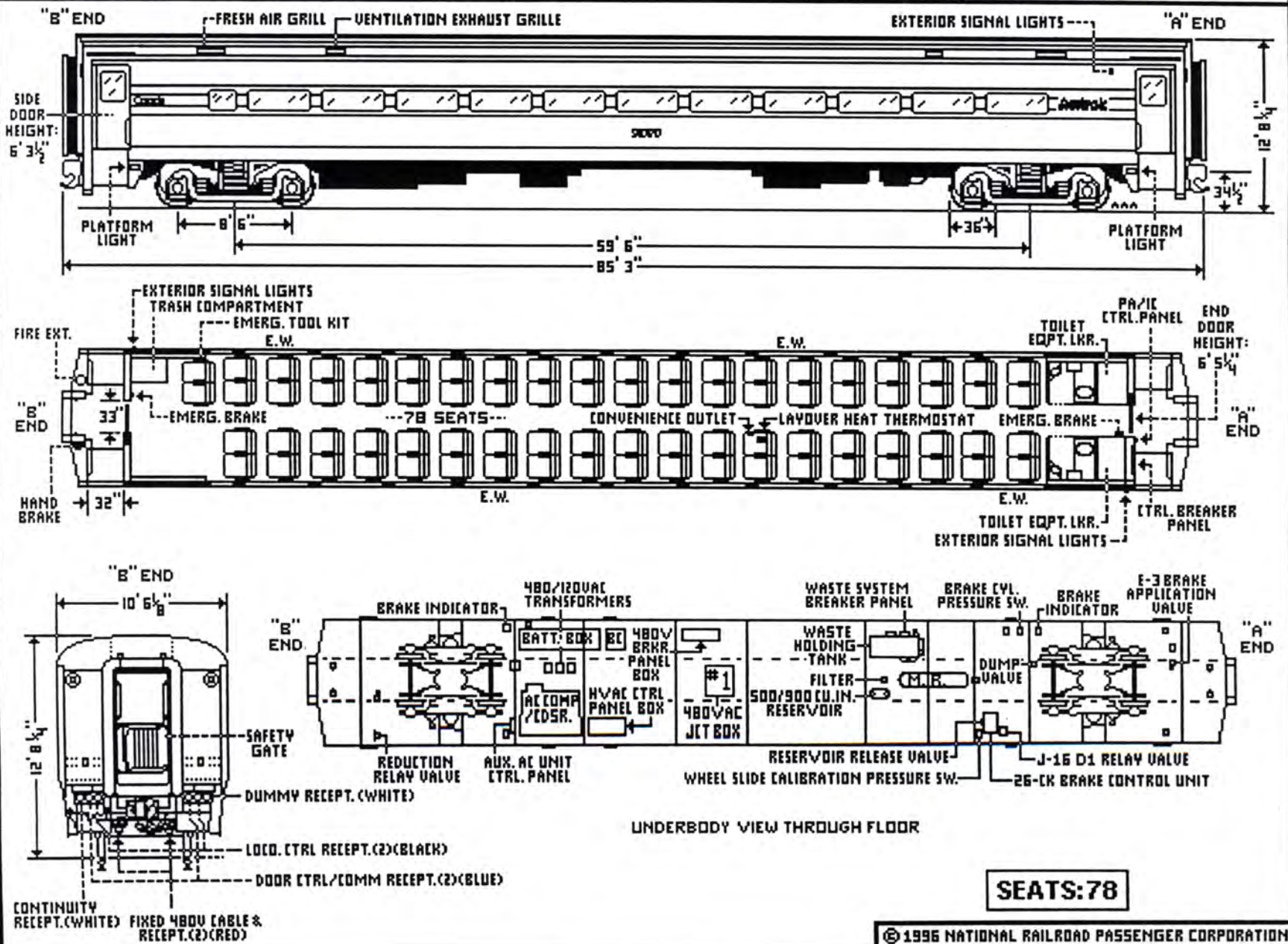

HORIZON FLEET COACH (HANDICAPPED)

Equipment Code: HC

125 MPH

Car Nos: 54500-54584

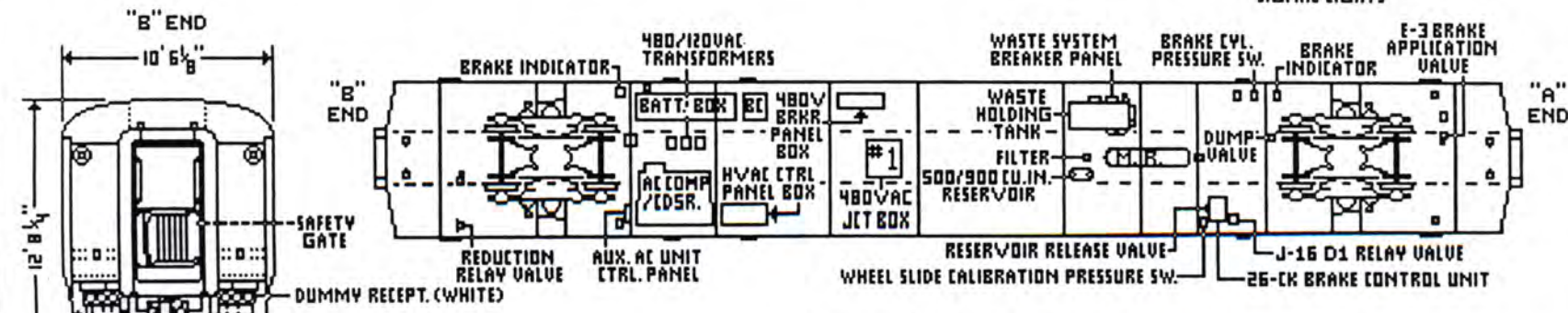
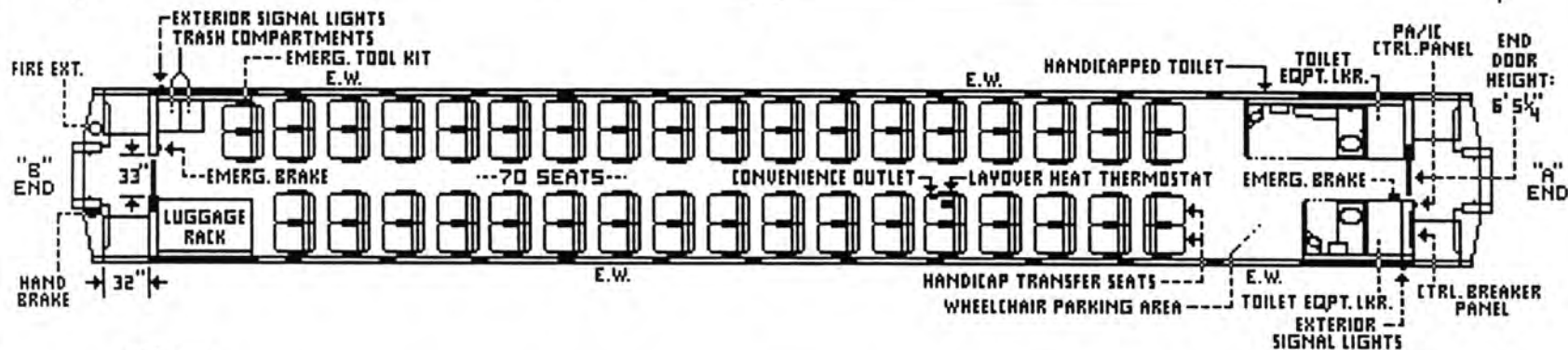
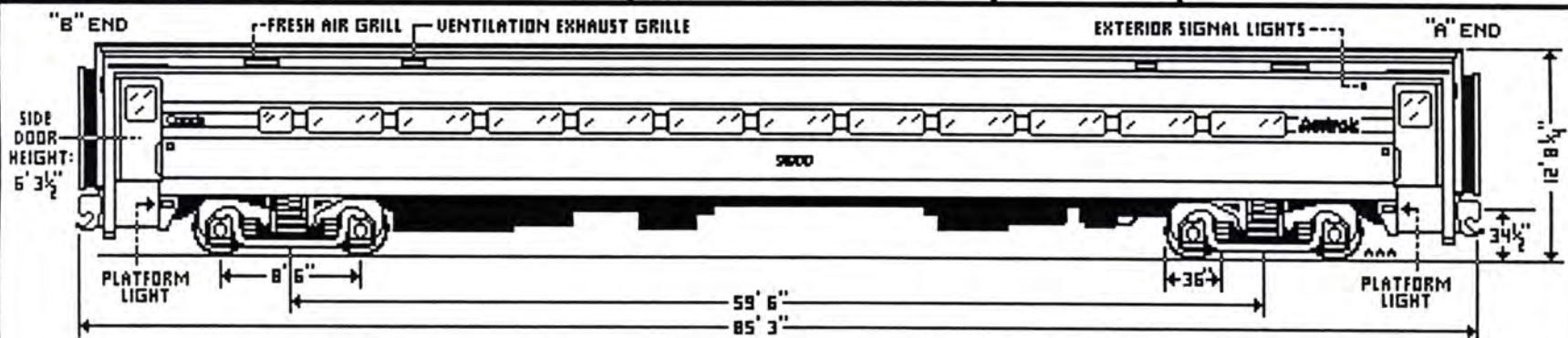

UNDERBODY VIEW THROUGH FLOOR

INCLUDES A.D.A. MODIFICATIONS

SEATS: 70

CONTINUITY RECEPT.(WHITE) FIXED 480V CABLE & RECEPT.(2)(RED)

DOOR CTRL/COMM RECEPT.(2)(BLUE)

LOCO. CTRL RECEPT.(2)(BLACK)

DUMMY RECEPT.(WHITE)

SAFETY GATE

VIEWLINER SLEEPING CAR

Equipment Code: VS

110 MPH

Car Numbers: 62000-62049

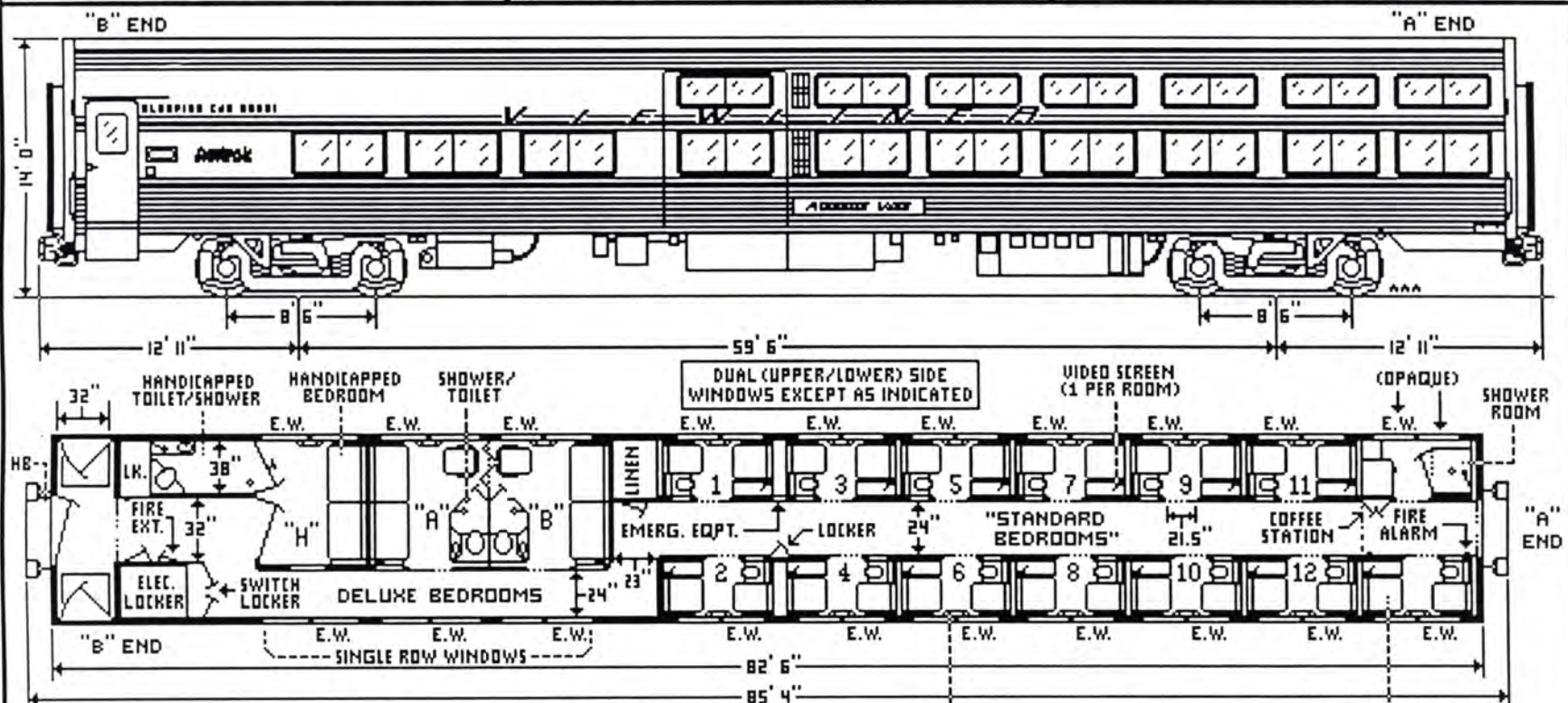

BEDROOMS "A" & "B" MAY BE CONVERTED TO A BEDROOM SUITE.

"STANDARD BEDROOMS" WERE FORMERLY CALLED "COMPARTMENTS"

ATTENDANT'S ROOM

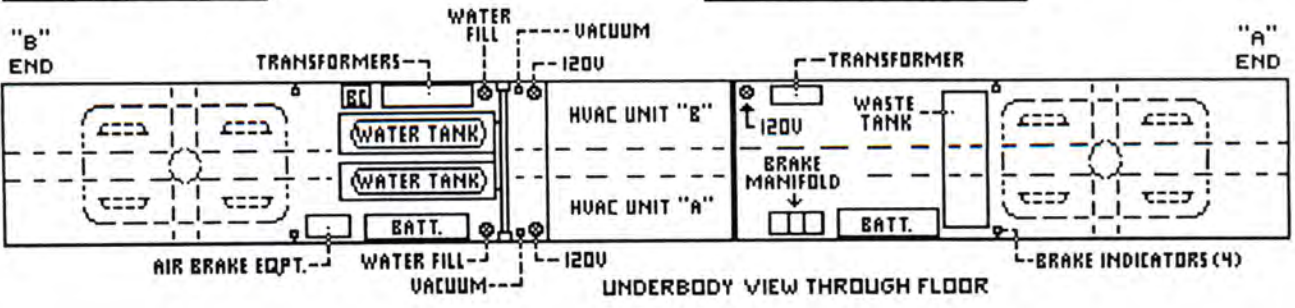
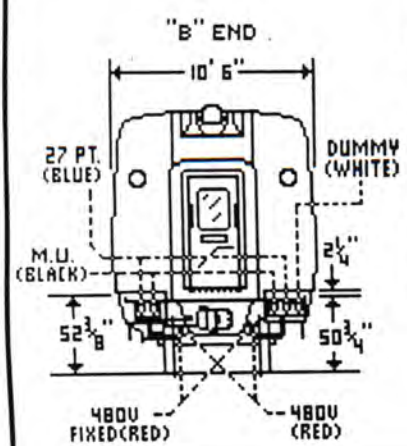

EXPRESS CAR (50-FOOT)

Equipment Code: ME

90 MPH

Car Nos: 70000-70049

DOOR OPENING:
HEIGHT: 10' 5"
WIDTH: 12' 0"

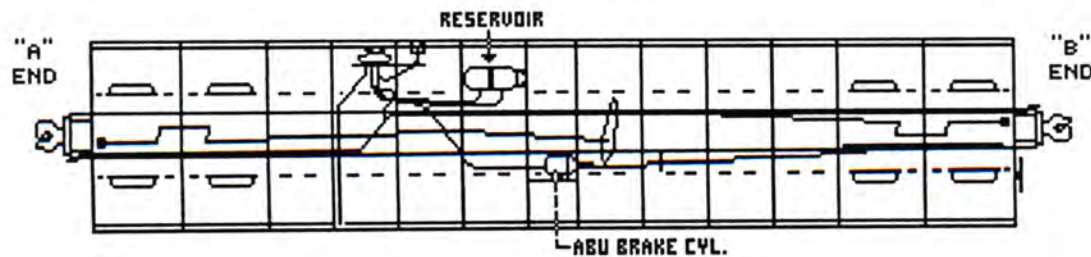
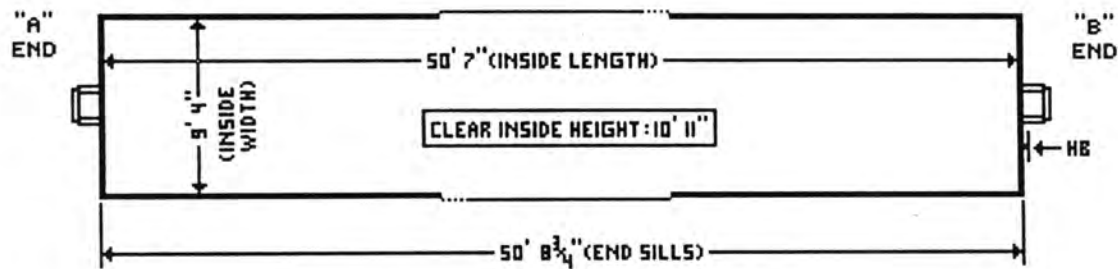
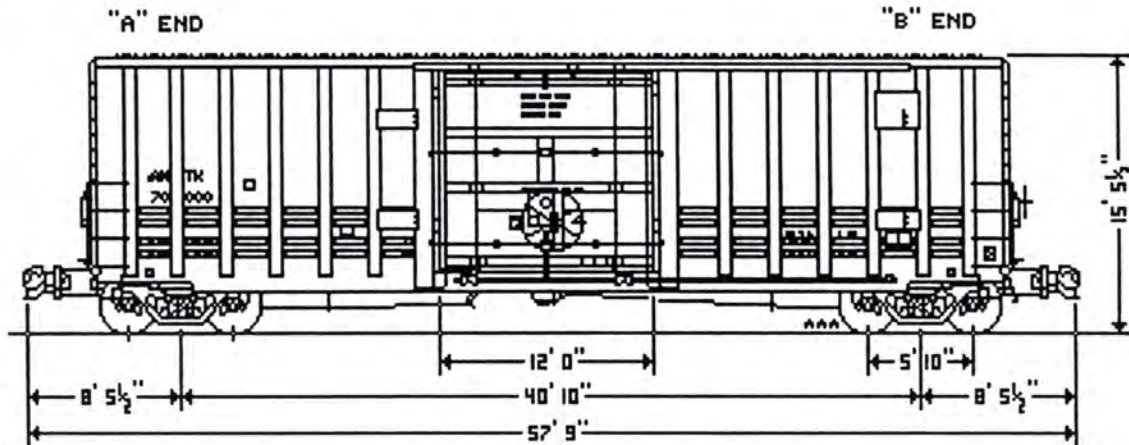

UNDERBODY VIEW THROUGH FLOOR

CARS NOT HEP EQUIPPED,
DIRECT-RELEASE BRAKING ONLY

EXPRESS CAR (60-FOOT)

Equipment Code: ME

90 MPH

Car Nos: 71000-71199

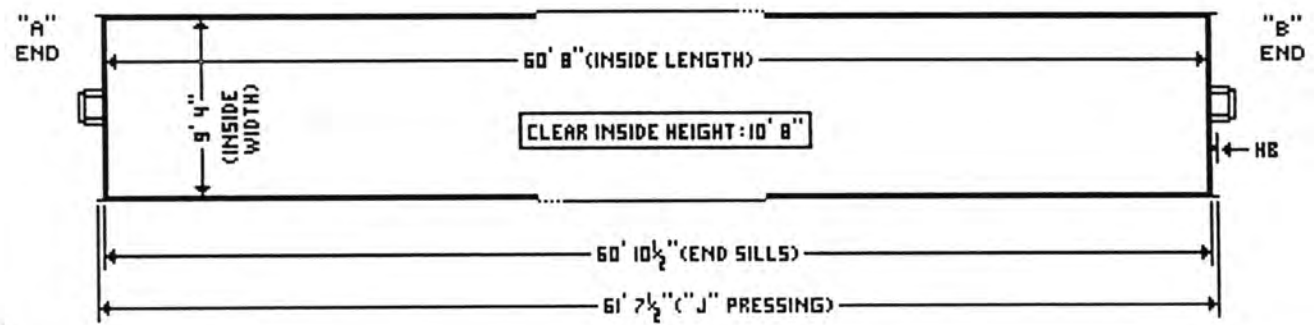
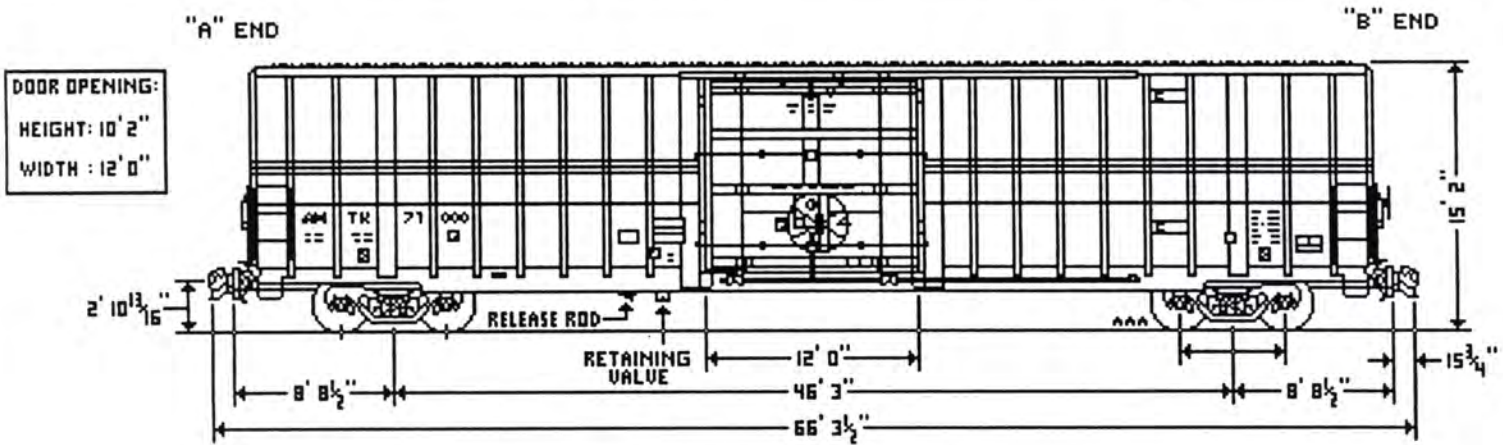

Note: Underbody view not yet available

CARS NOT HEP EQUIPPED,
DIRECT-RELEASE BRAKING ONLY

NORTH CAROLINA DOT HEP COACH

Eqpt. Code: NC

110 MPH

Car Numbers: 400001-400005

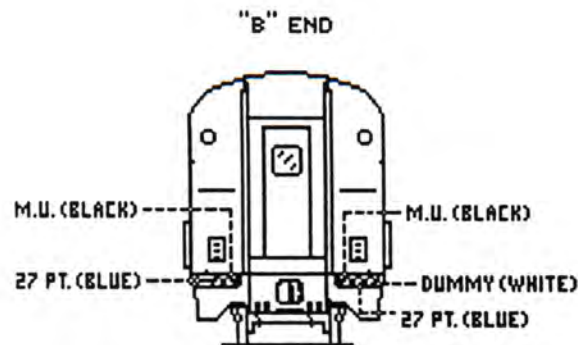
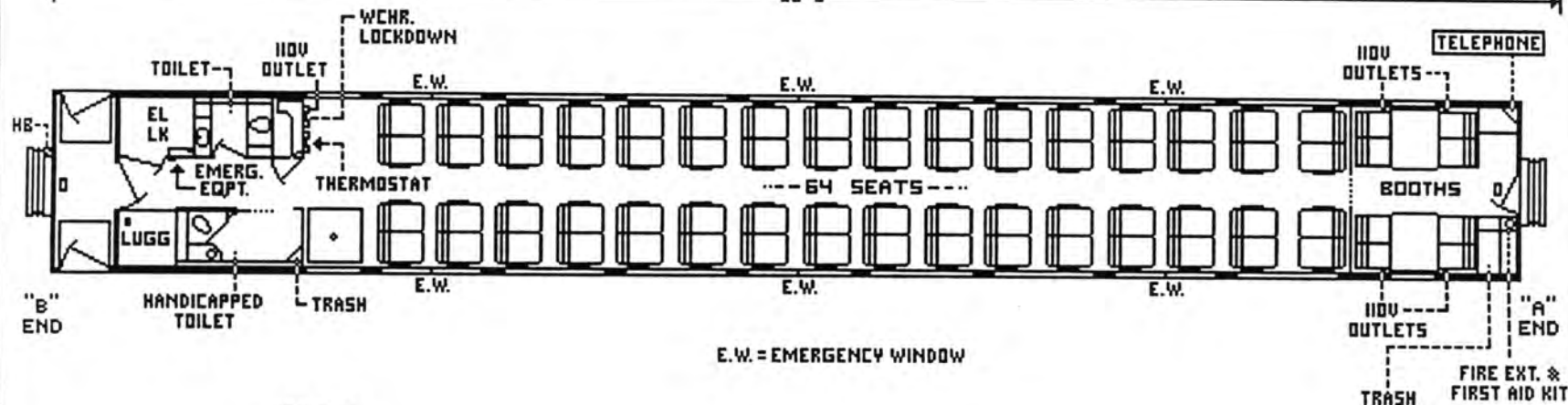
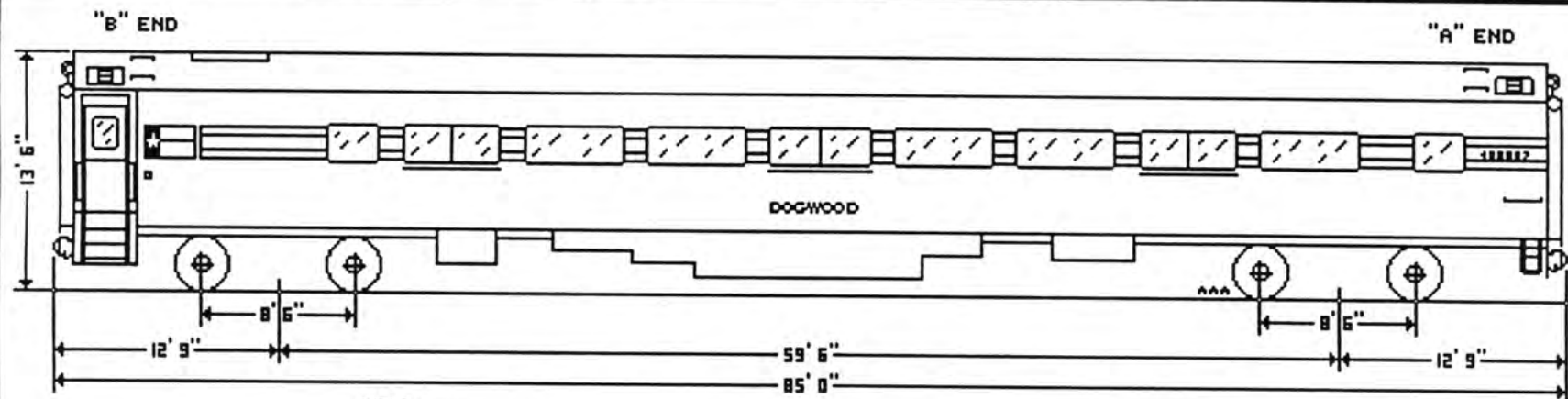

- 400001 - CARDINAL
- 400002 - DOGWOOD
- 400003 - HONEY BEE
- 400004 - LONG LEAF PINE
- 400005 - SCOTCH BONNET

TABLE SEATS: 8
COACH SEATS: 64

P-42 DIESEL LOCOMOTIVE

4250 HP

Eqpt. Code: BD

110 MPH

Unit Nos: 1-140

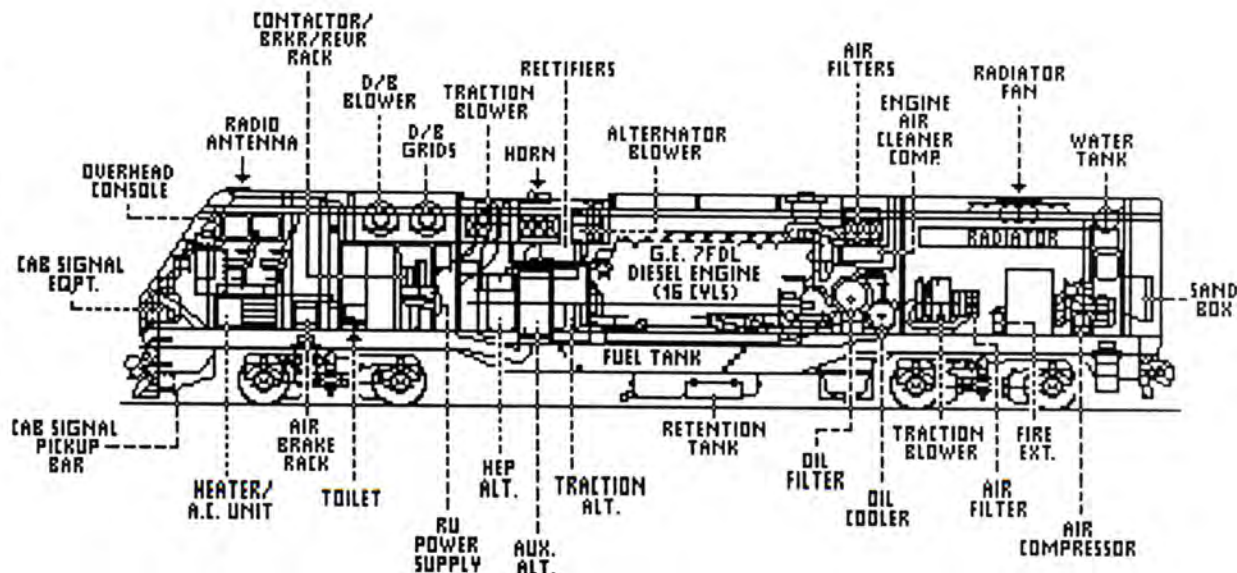
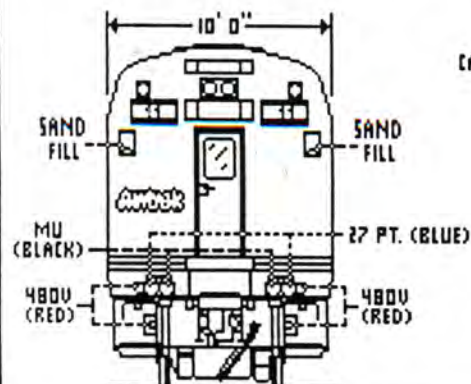
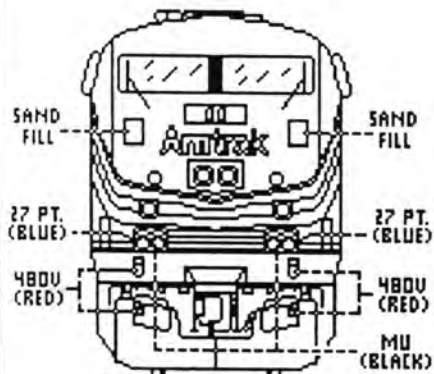
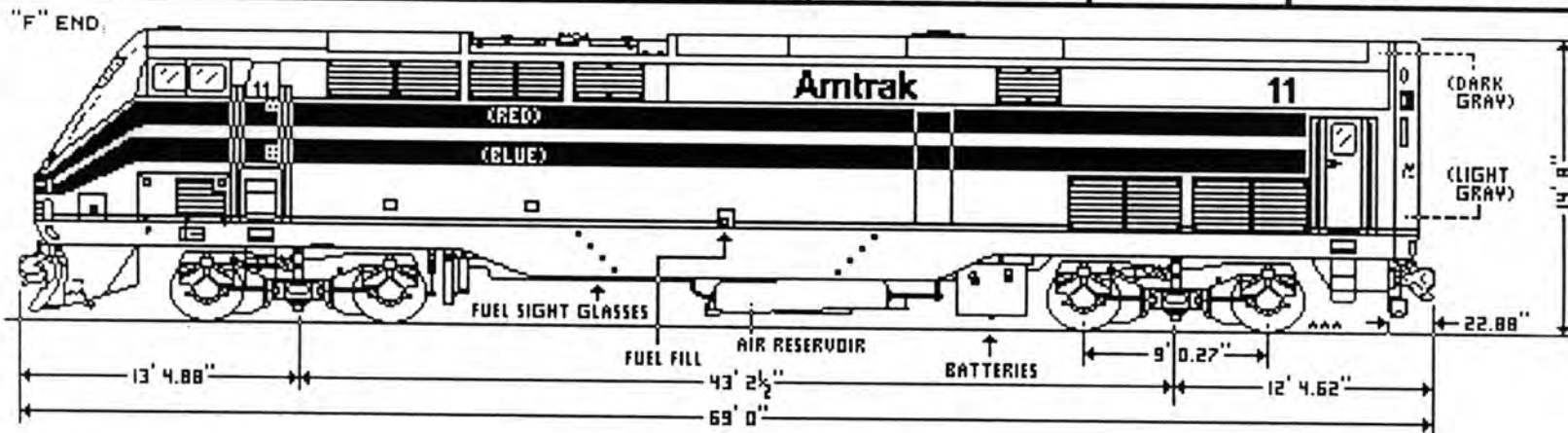

CUTAWAY VIEW

SPECIAL THANKS:
GENERAL ELECTRIC
REFER TO G.E. DASH B-426P
OPERATING MANUAL.

GP40PH DIESEL LOCOMOTIVE

3000 HP

Eqpt. Code: GC

100 MPH

Unit Nos: 192-199

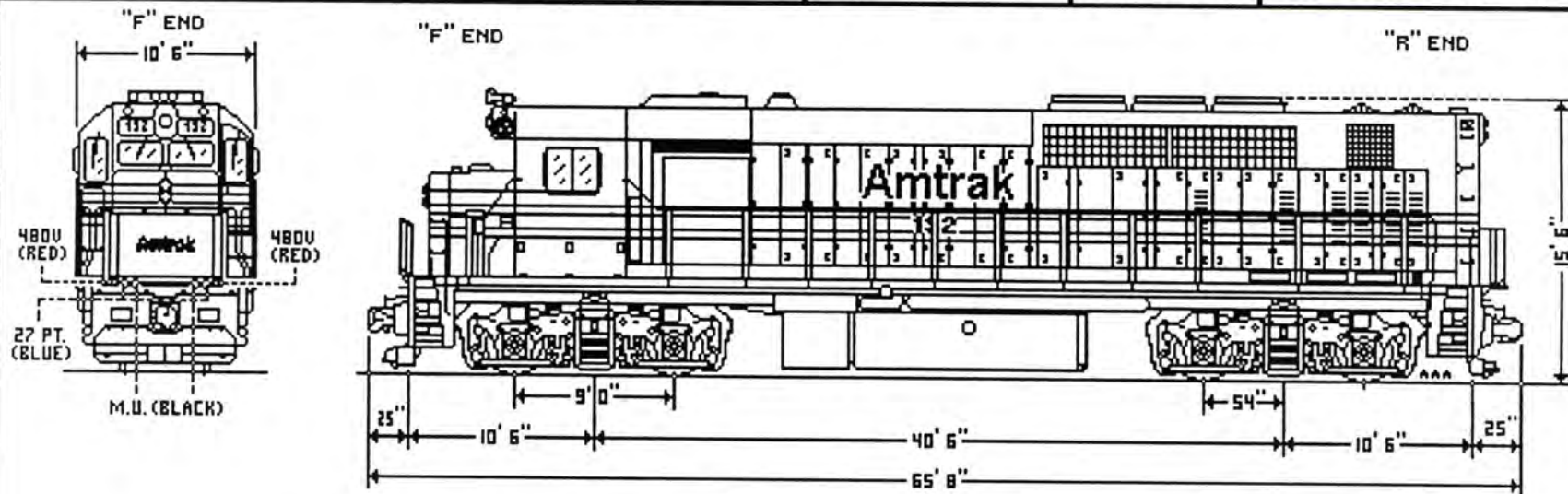

CUTAWAY VIEW

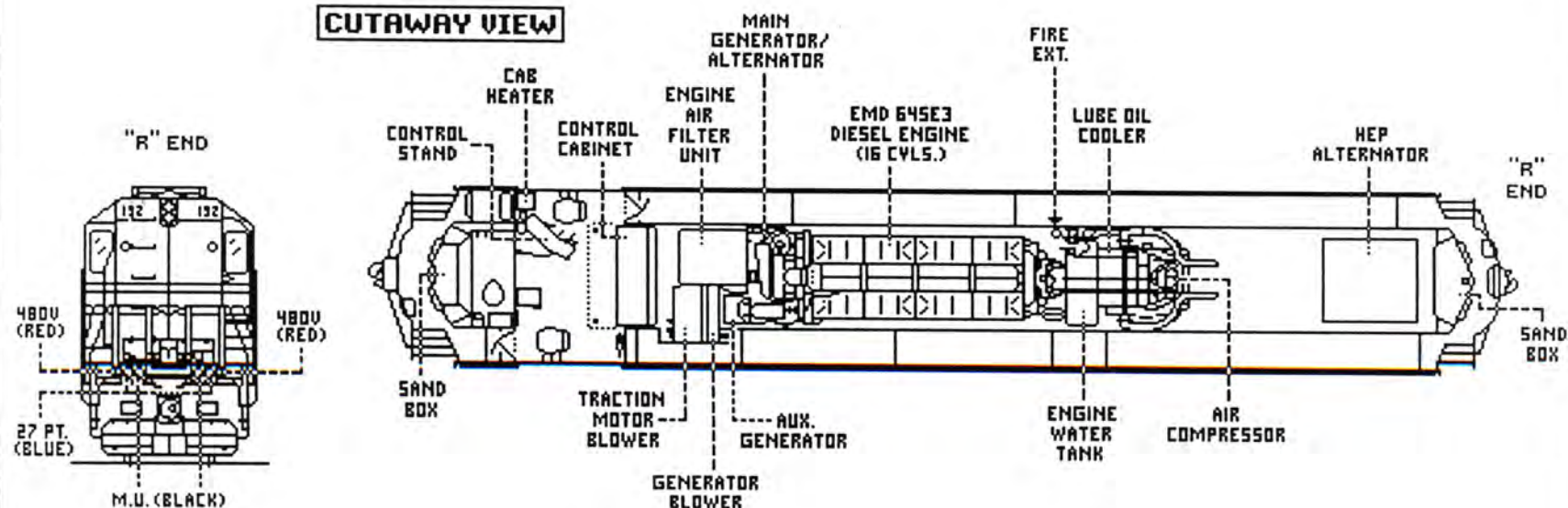

F-40PH DIESEL LOCOMOTIVE

3000 HP

Eqpt. Code: FP

100 MPH

Unit Nos: 200-415

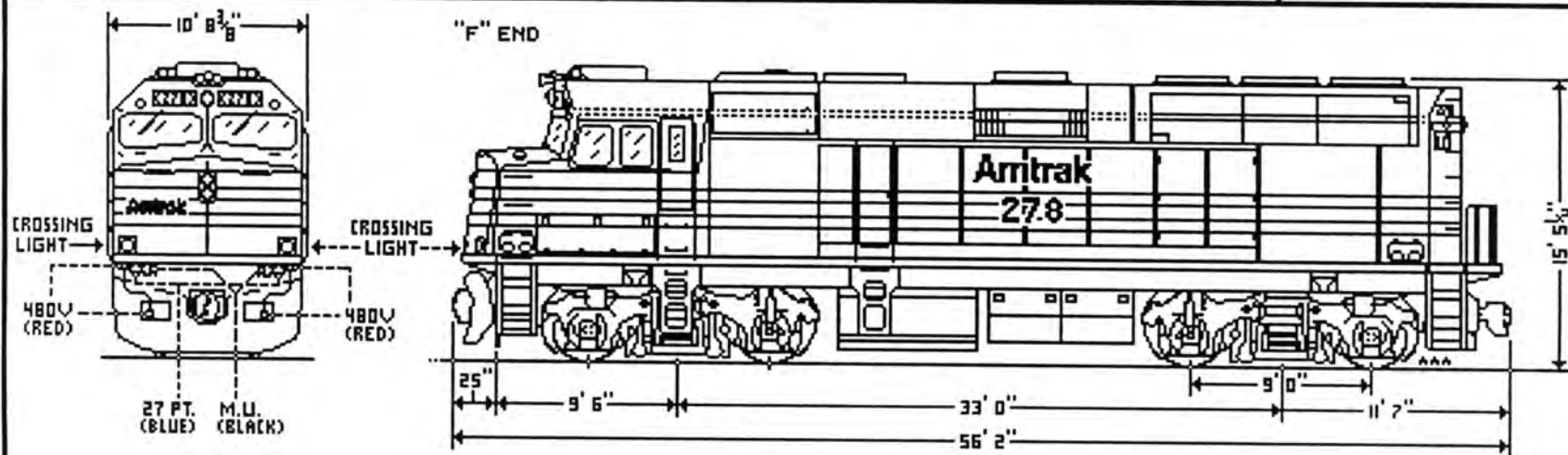

CUTAWAY VIEW

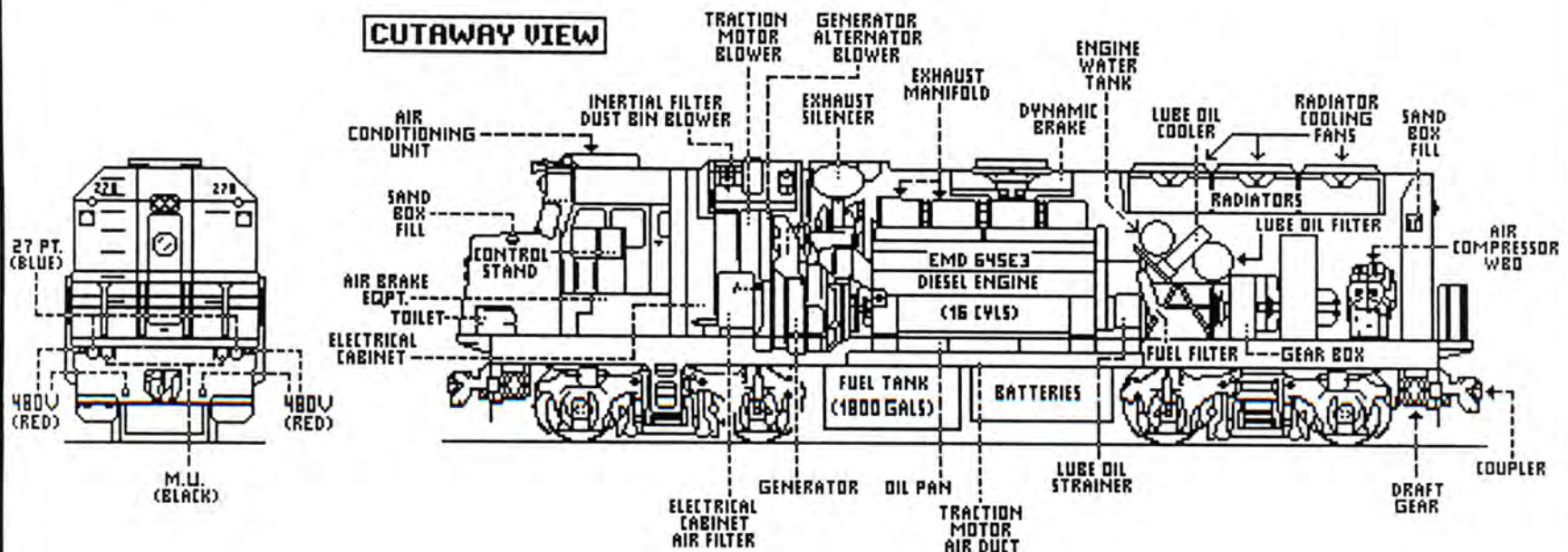

FL-9 DIESEL/DC THIRD RAIL LOCOMOTIVE

1750 HP

Eqpt. Code: FL

100 MPH

Unit Nos: 484-489

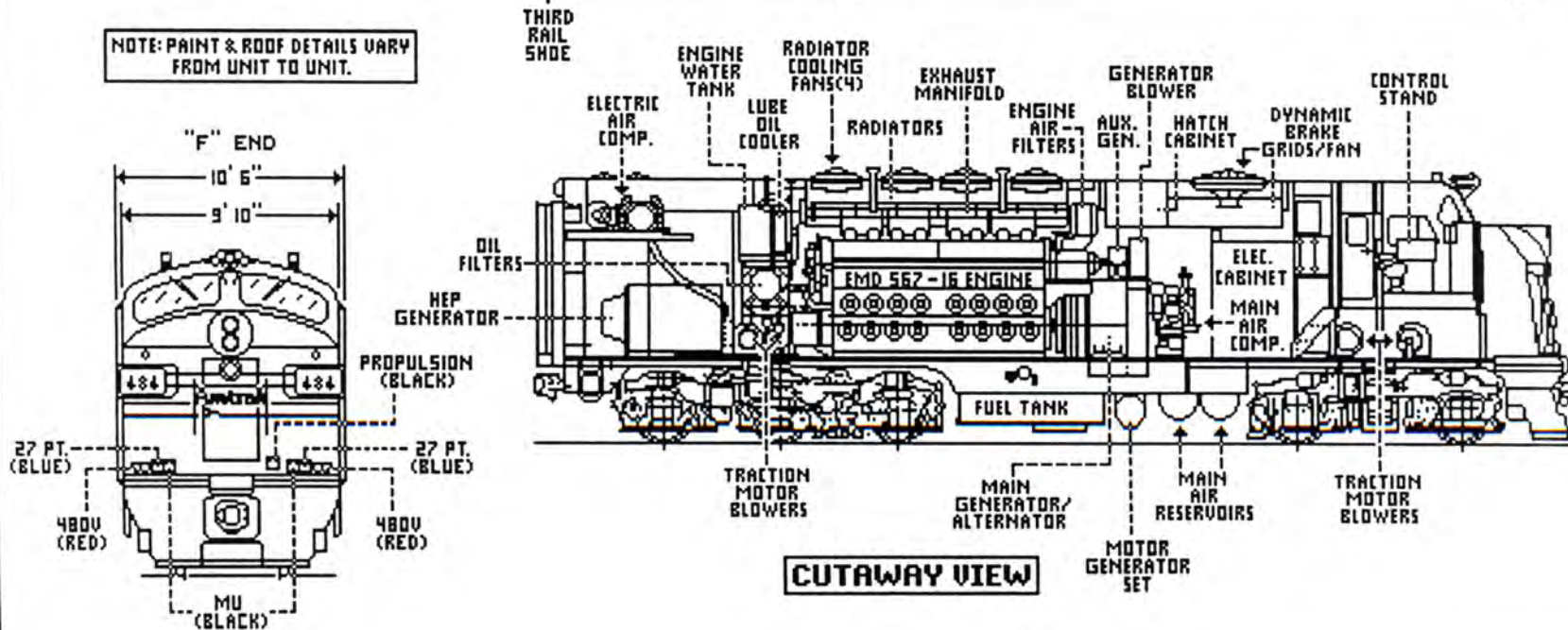
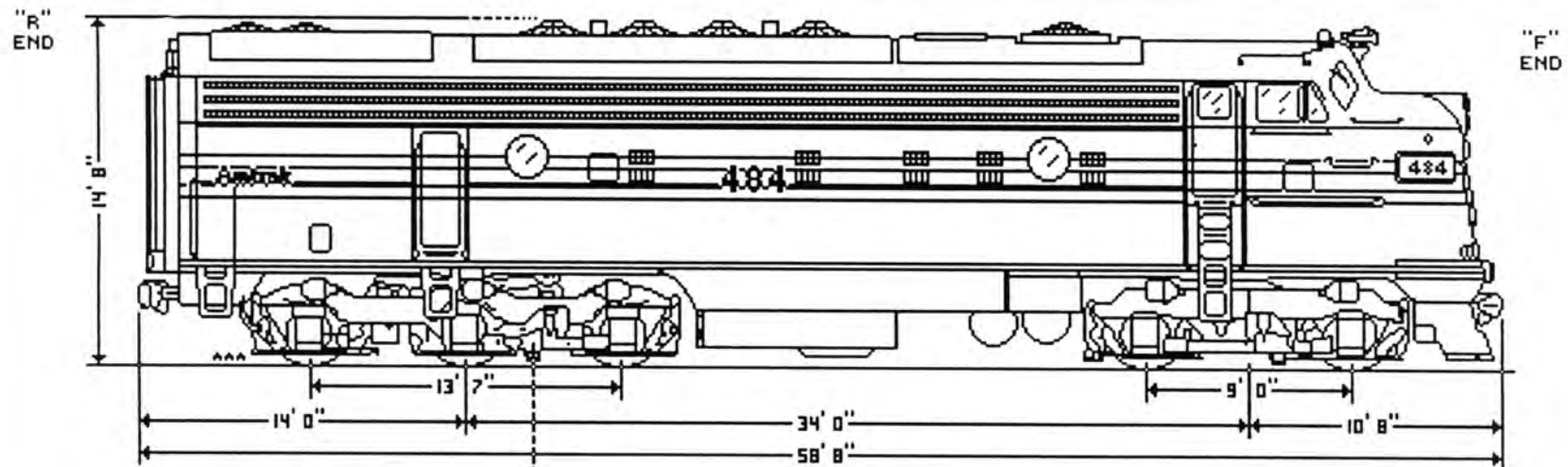

P32-8 DIESEL LOCOMOTIVE

3200 HP

Eqpt. Code: BH

100 MPH

Unit Nos: 500-519

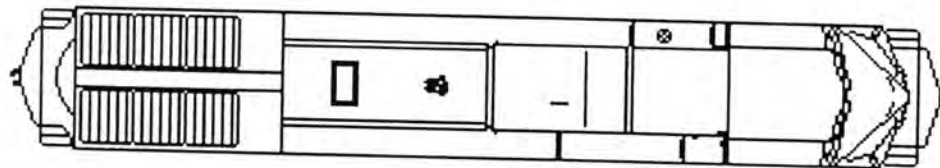
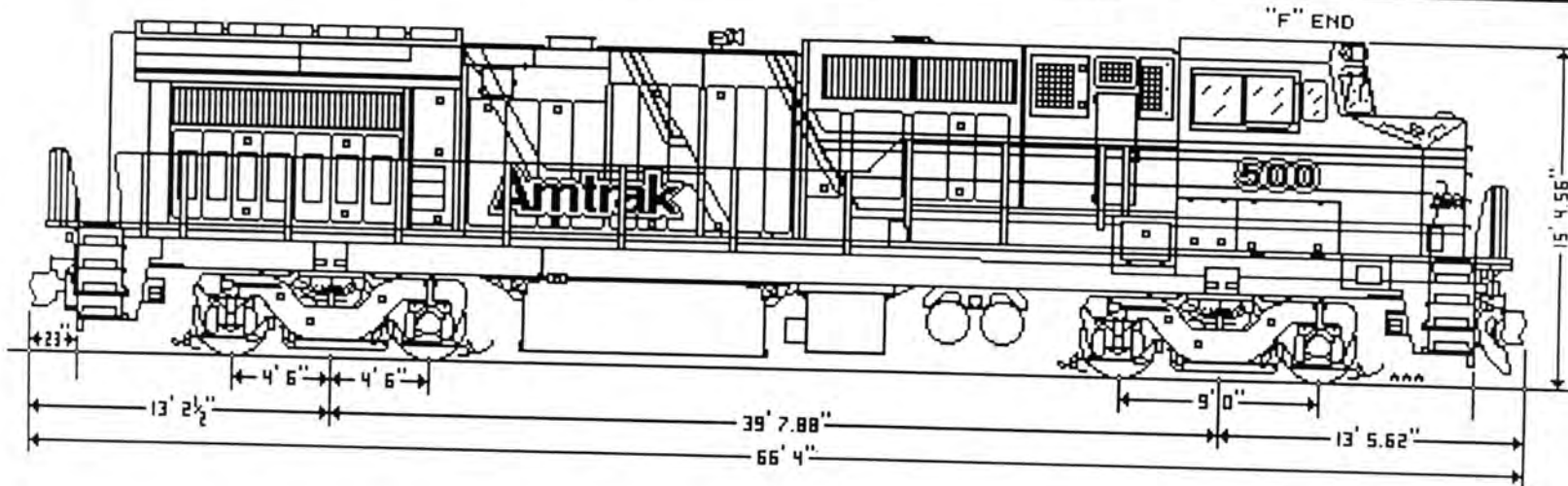

OVERHEAD VIEW

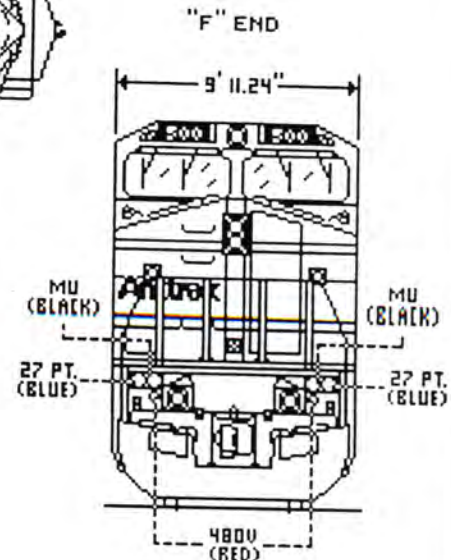
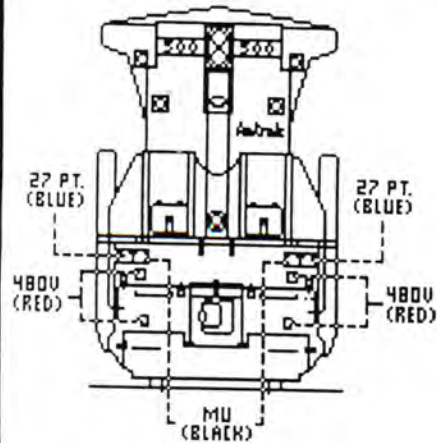

NOTE: BUILDER'S MODEL IS DASH B-32BWH

E-60MA ELECTRIC LOCOMOTIVE

6000 HP

Eqpt. Code: EM

90 MPH

Unit Nos: 600-610

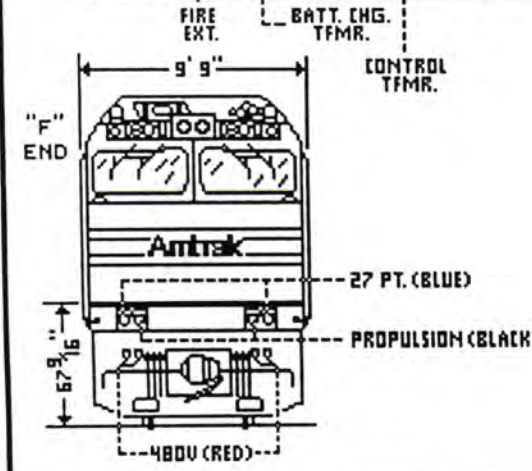
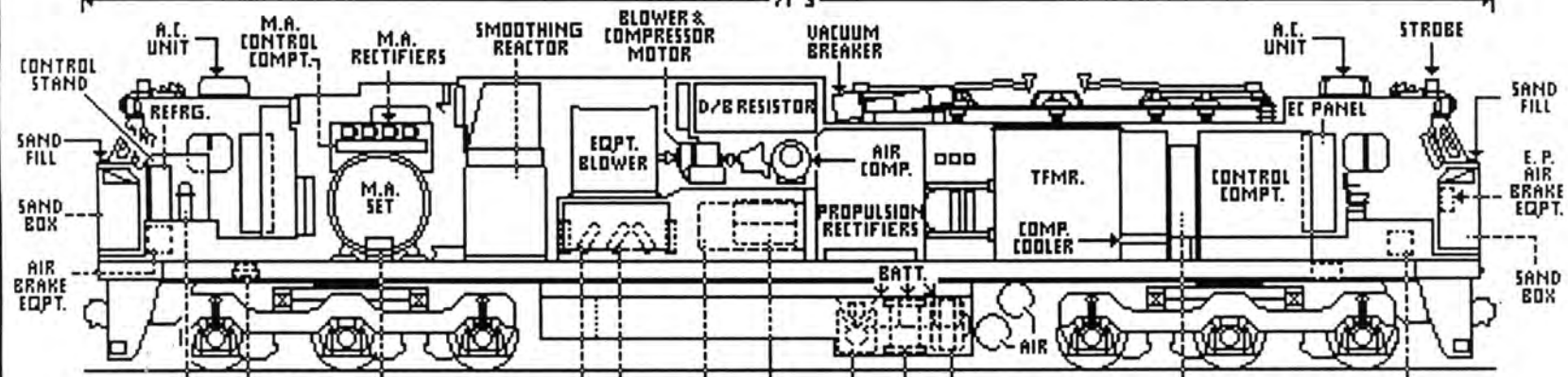
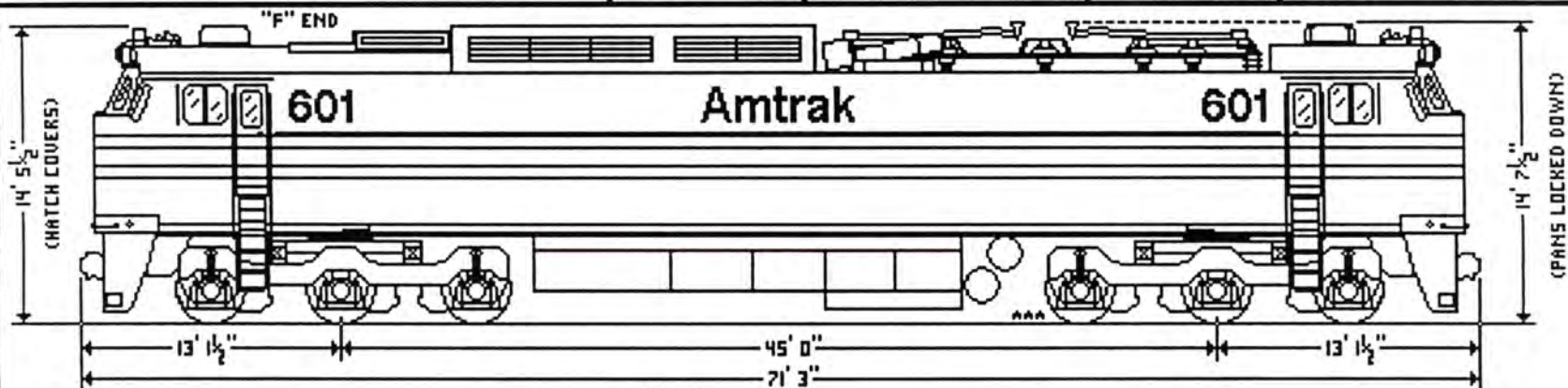

E-60CP ELECTRIC LOCOMOTIVE

6000 HP

Eqpt. Code: EP

80 MPH

Unit Nos: 620, 621

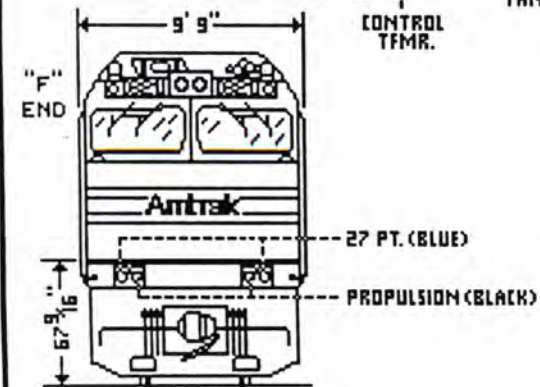
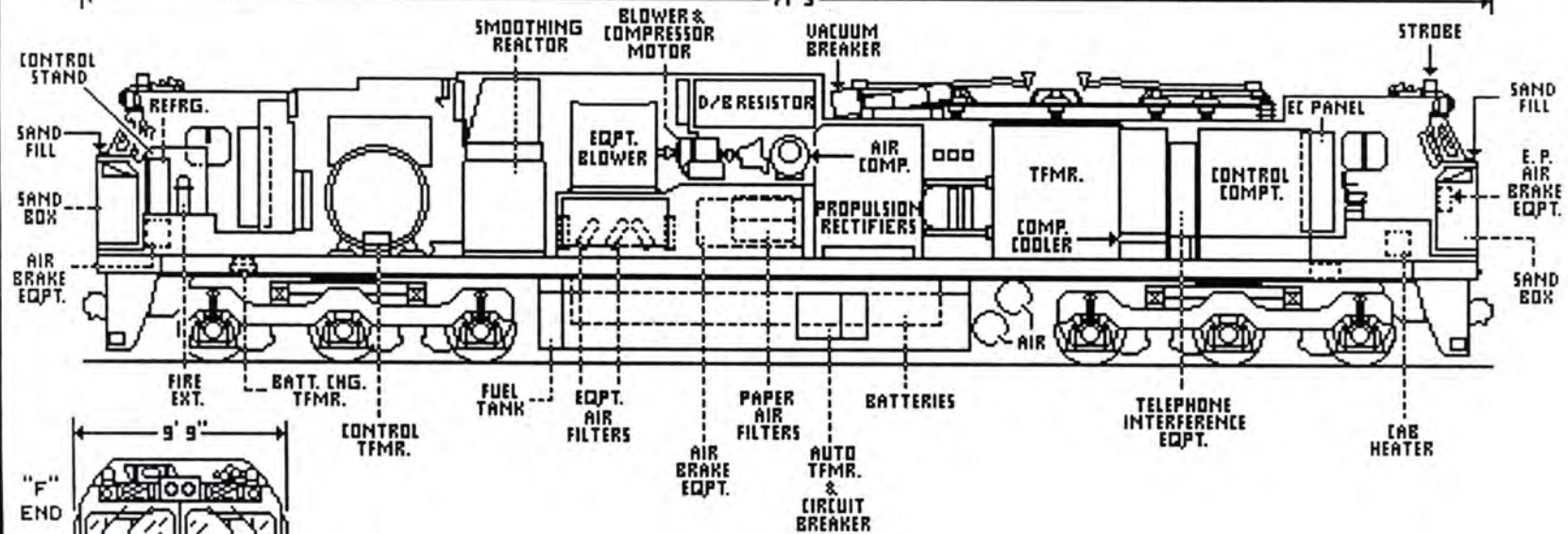
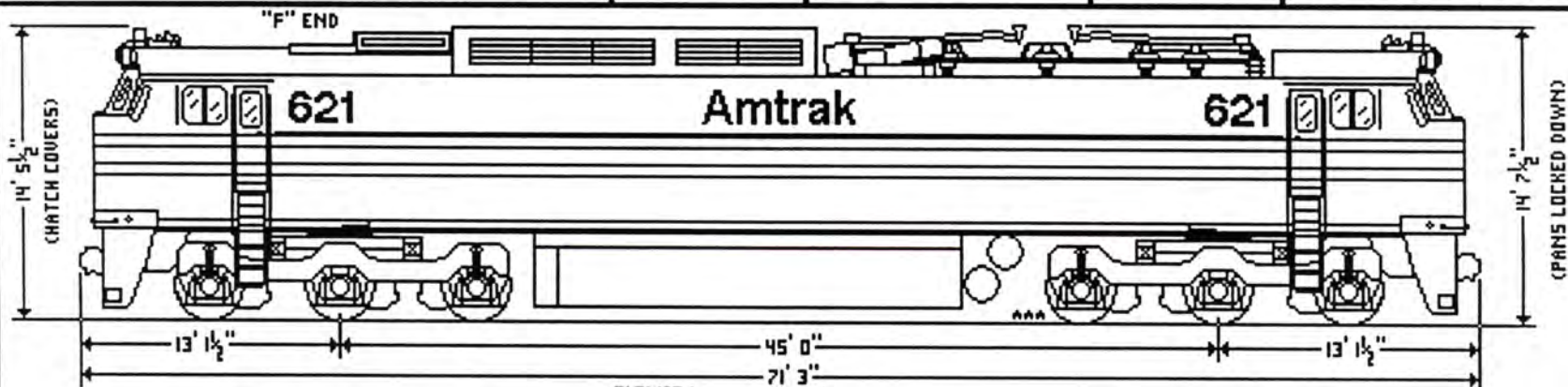

NOTE: NOT H.E.P. EQUIPPED

P32AC-DM DIESEL/DC THIRD RAIL LOCOMOTIVE

3200 HP

Eqpt. Code: DM

110 MPH

Unit Nos: 700-709

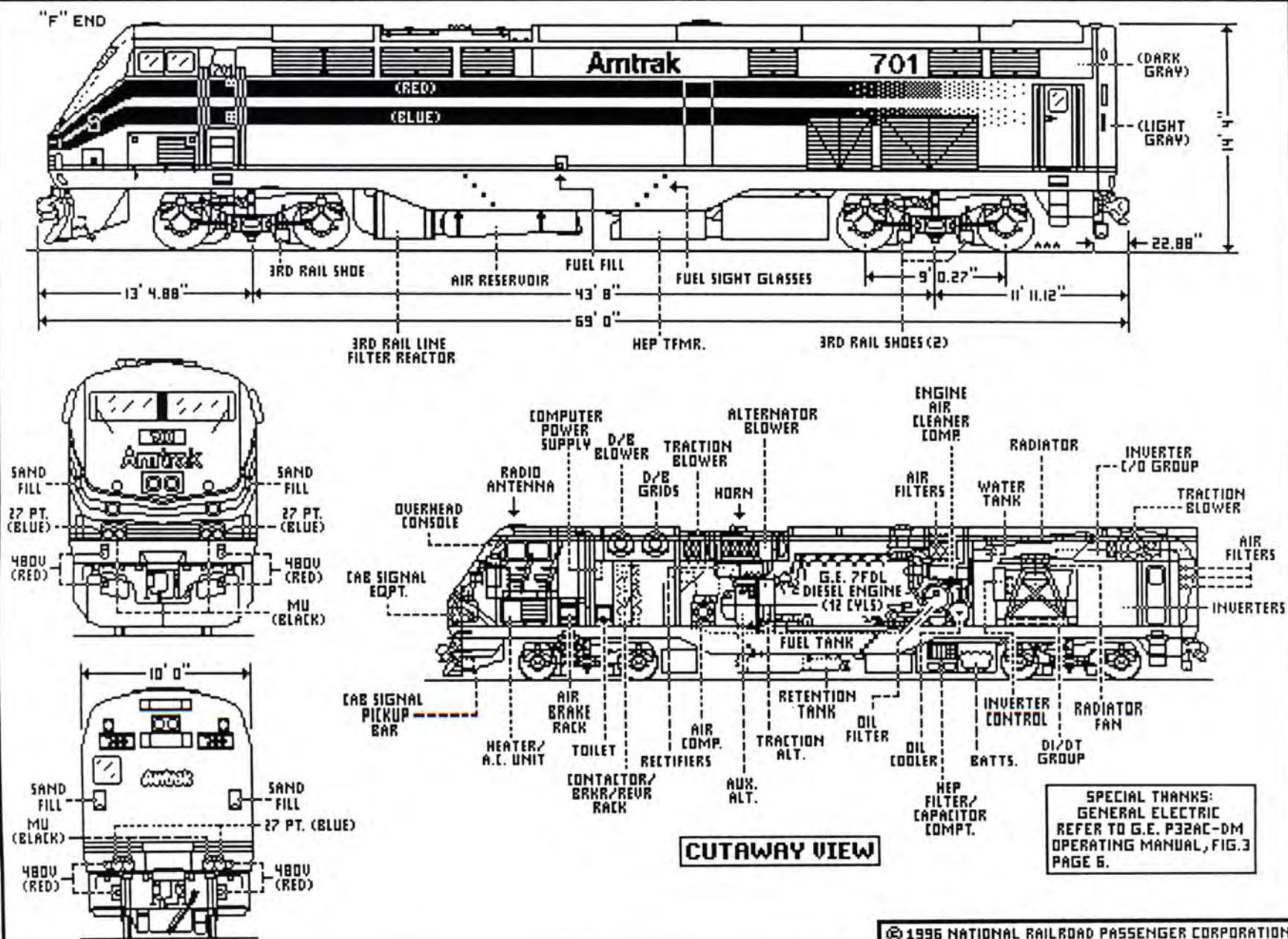

P-40 DIESEL LOCOMOTIVE

4000 HP

Eqpt. Code: BP

100 MPH

Unit Nos: 800-843

"F" END

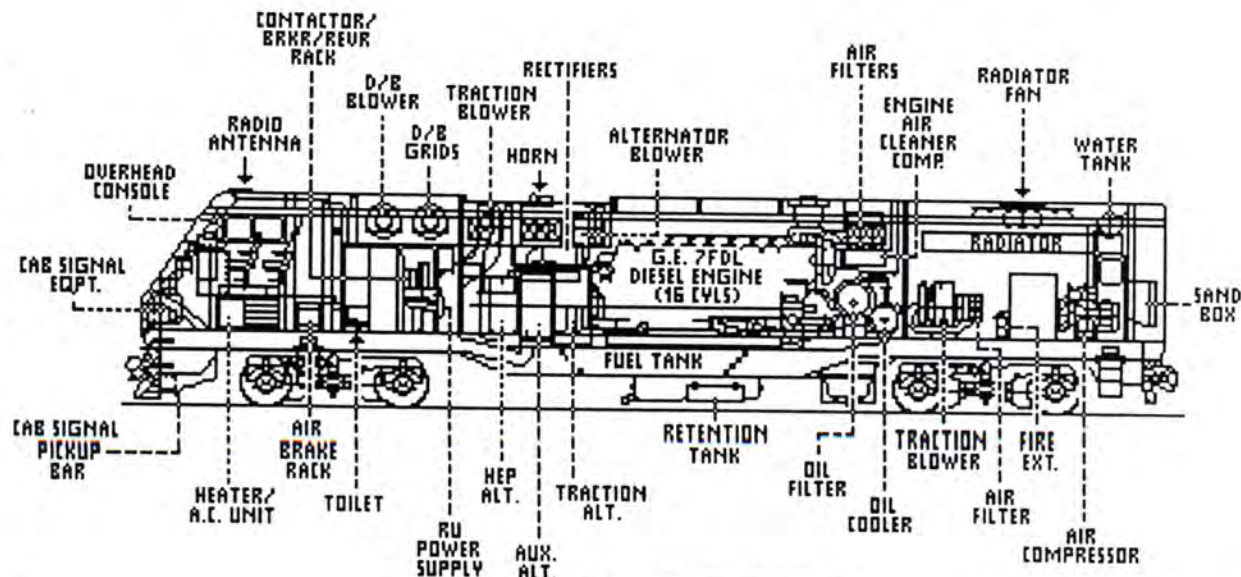
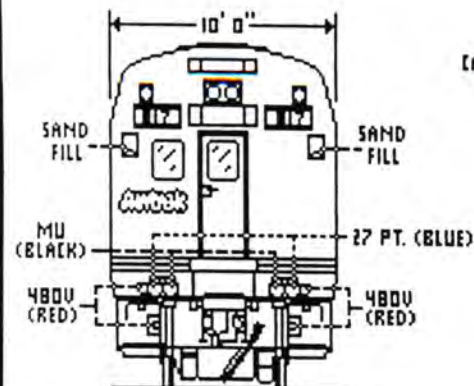
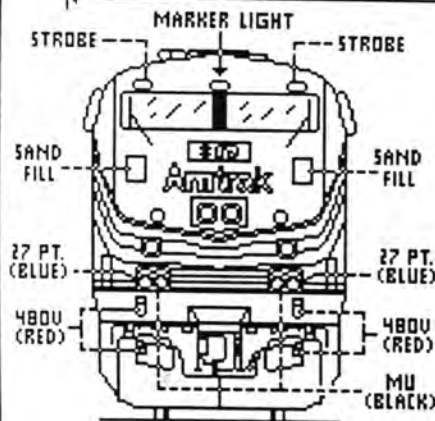
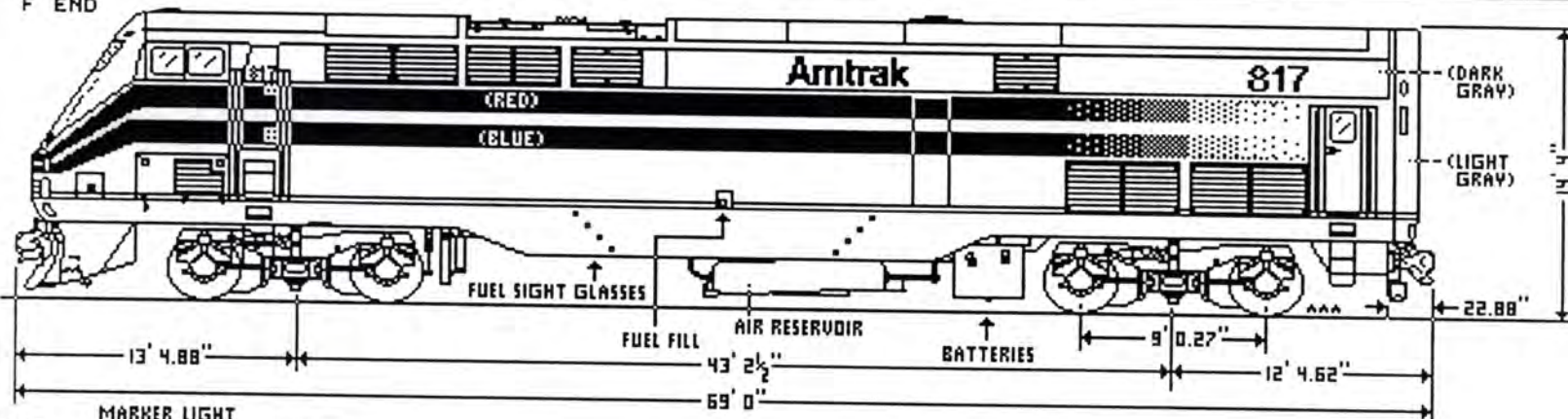

CUTAWAY VIEW

SPECIAL THANKS:
GENERAL ELECTRIC
REFER TO G.E. DASHB-408P
OPERATING MANUAL, FIG.2
PAGE 5.

AEM-7 ELECTRIC LOCOMOTIVE

7000 HP

Eqpt. Code: AE

125 MPH

Unit Nos: 901-953

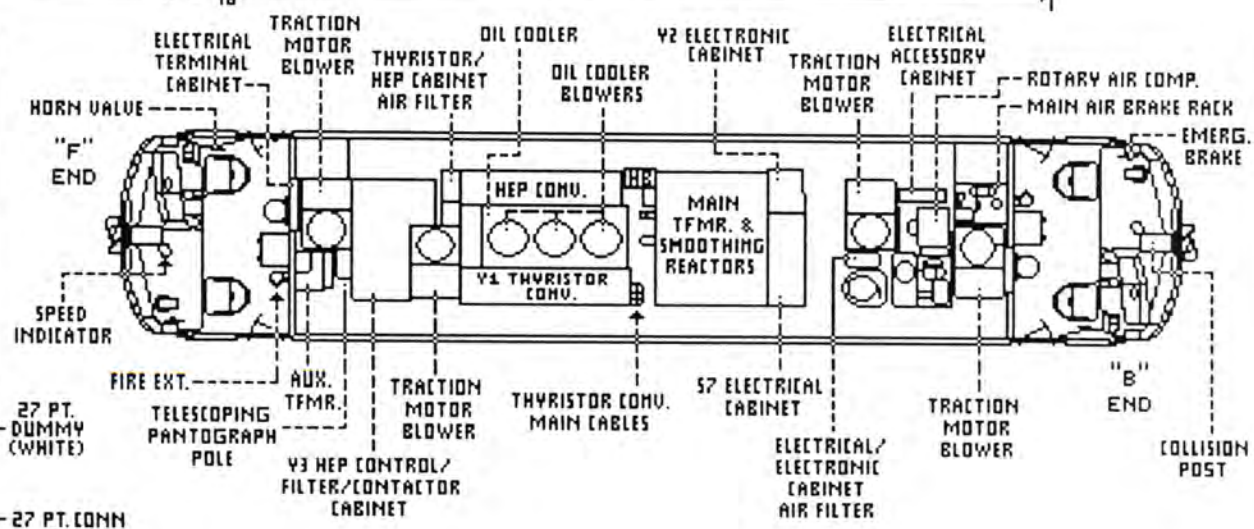
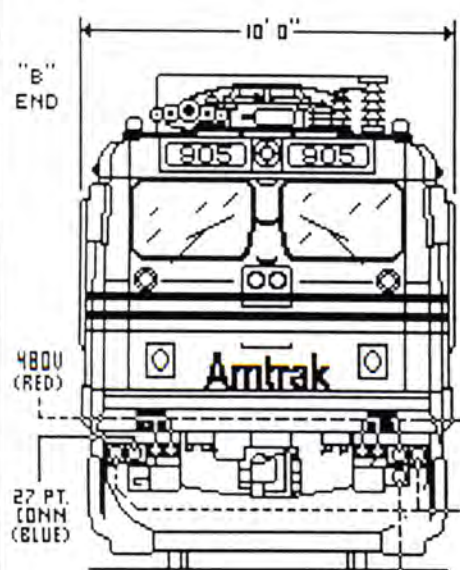
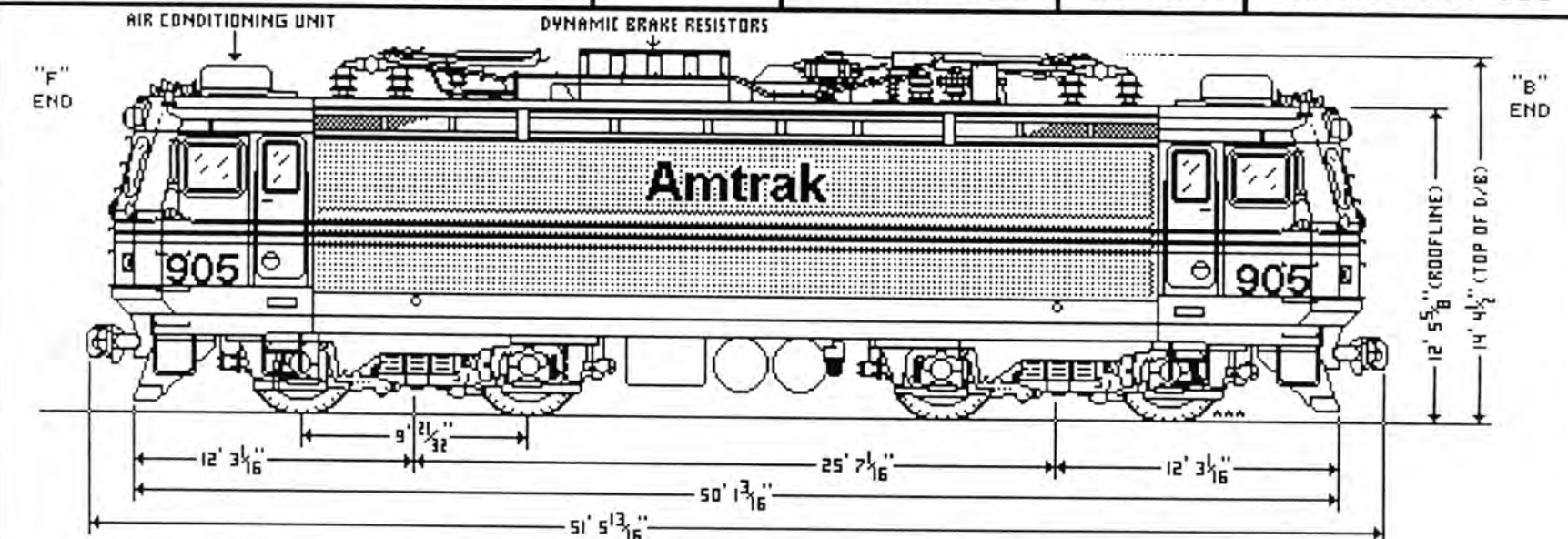

TALGO POWER CAR

Equipment Code:

125 MPH

Talgo

SIDE VIEW

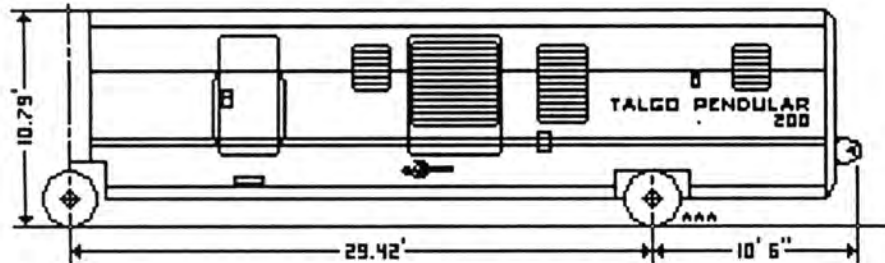

REAR END VIEW

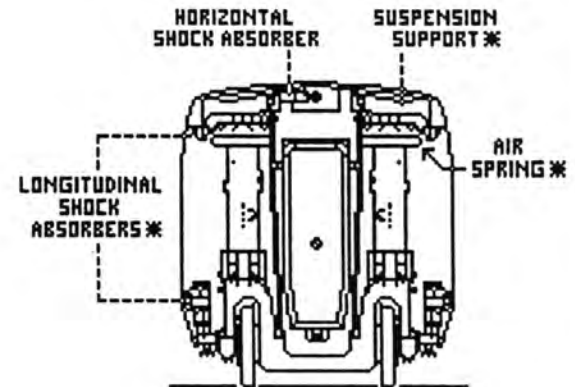

* = ONE SET EACH SIDE

FLOOR PLAN

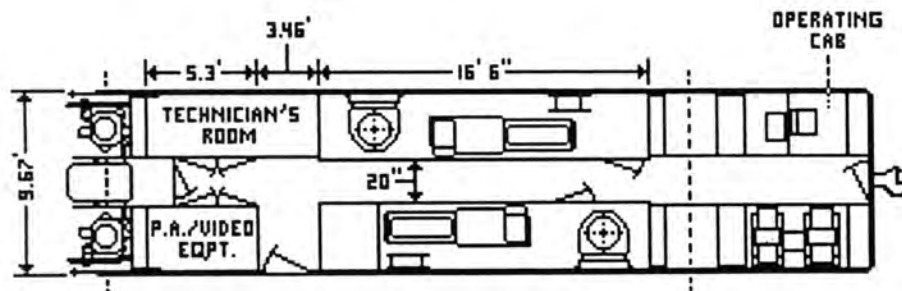

CAB END VIEW

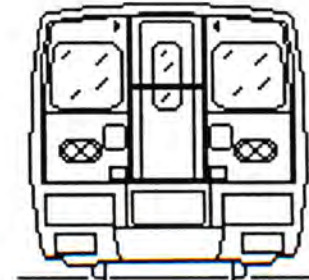

NOTE: NOT A PASSENGER CARRYING CAR.

TALGO COACH (2/1 SEATING)

Equipment Code:

125 MPH

Talgo

SIDE VIEW

+++ ALL WINDOWS ARE EMERGENCY WINDOWS +++

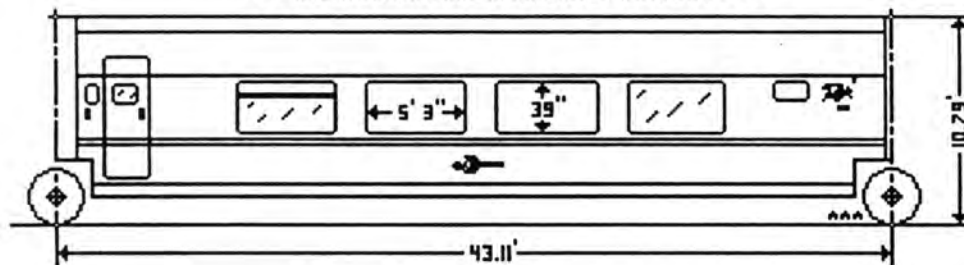

END VIEW

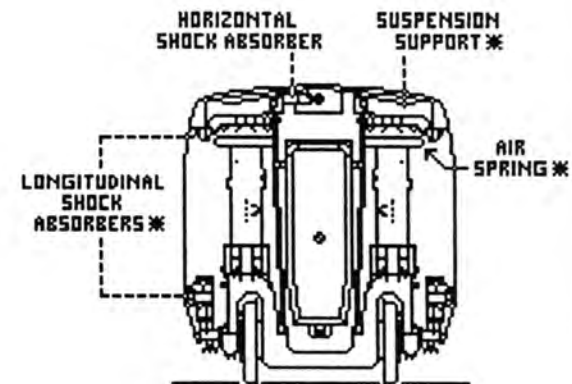

* = ONE SET EACH SIDE

FLOOR PLAN

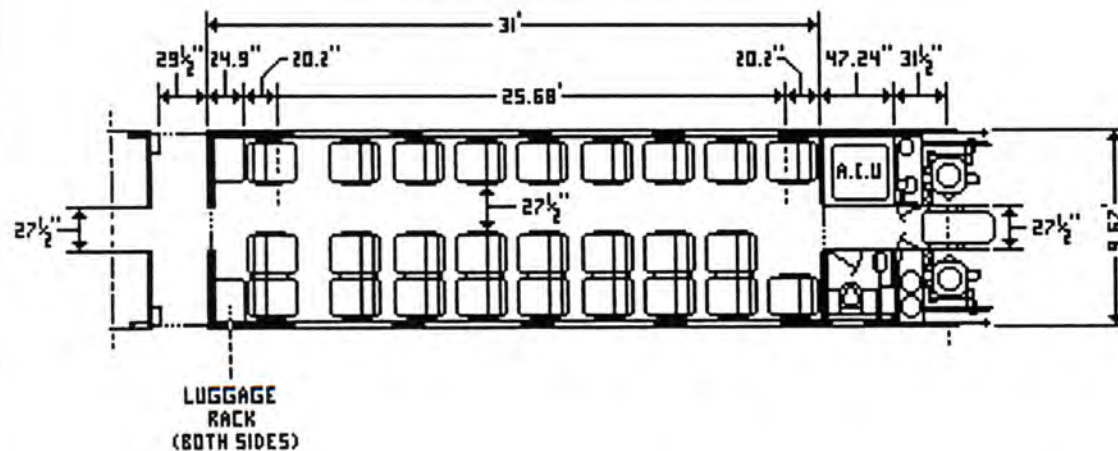

NOTE: IN EUROPE, THESE 2/1 SEATING CARS ARE SOLD AS FIRST CLASS.

SEATS: 26

TALGO COACH (2/2 SEATING)

Equipment Code:

125 MPH

Talgo

SIDE VIEW

ALL WINDOWS ARE EMERGENCY WINDOWS

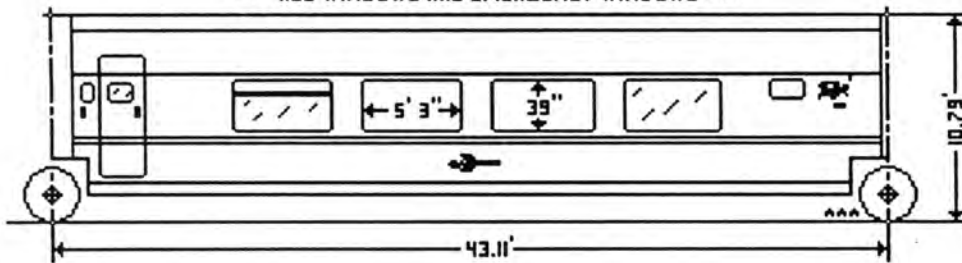

END VIEW

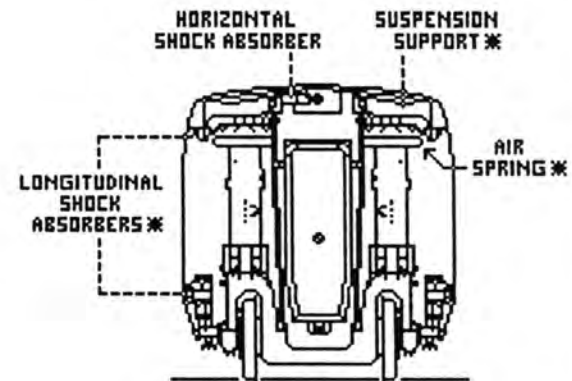

* = ONE SET EACH SIDE

FLOOR PLAN

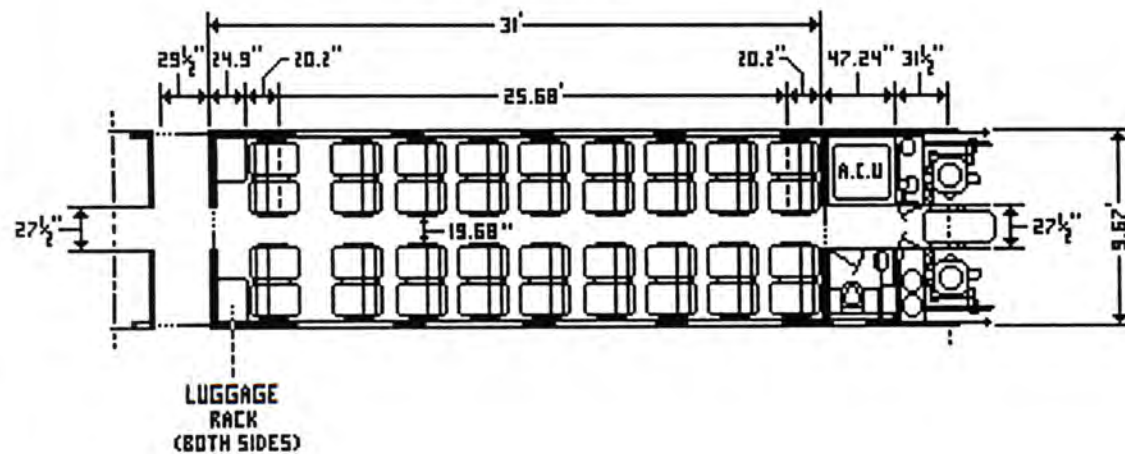

SEATS: 36

TALGO BISTRO (SNACK) CAR

Equipment Code:

125 MPH

Talgo

SIDE VIEW

*** ALL WINDOWS ARE EMERGENCY WINDOWS ***

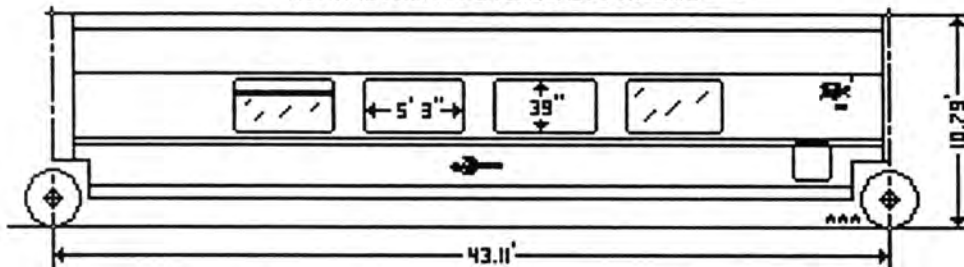

END VIEW

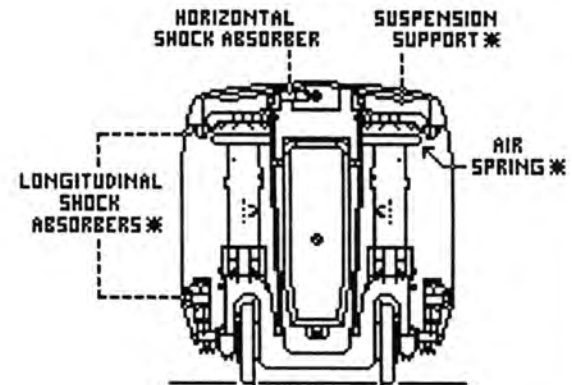

* = ONE SET EACH SIDE

FLOOR PLAN

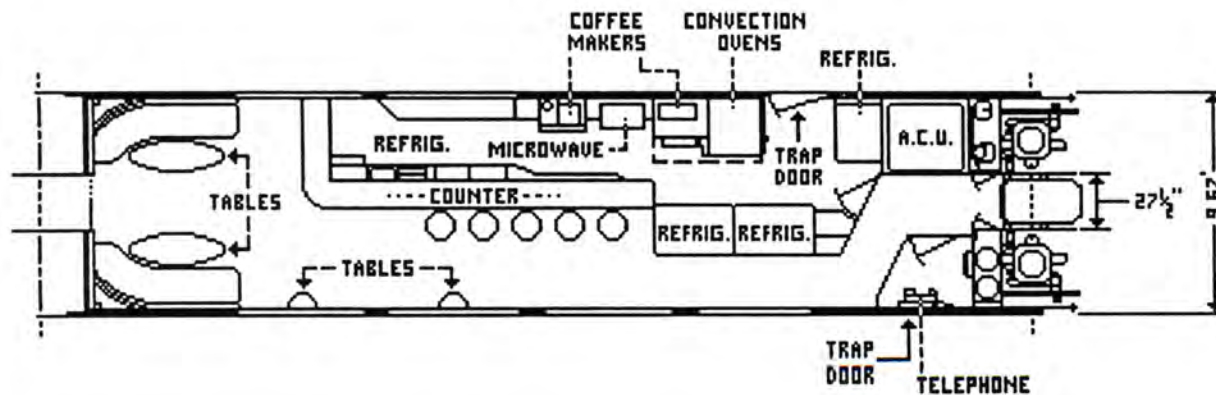

TALGO TABLE (DINING) CAR

Equipment Code:

125 MPH

Talgo

SIDE VIEW

*** ALL WINDOWS ARE EMERGENCY WINDOWS ***

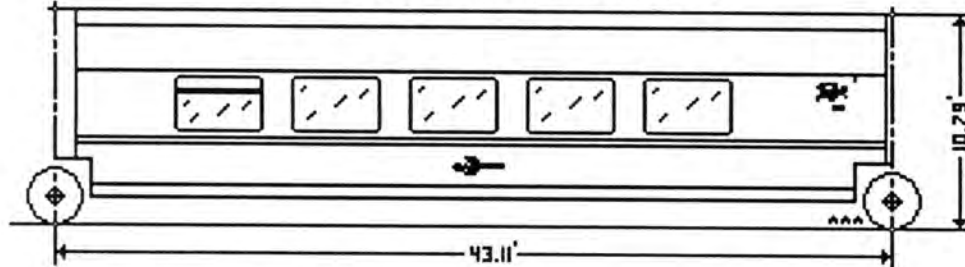

END VIEW

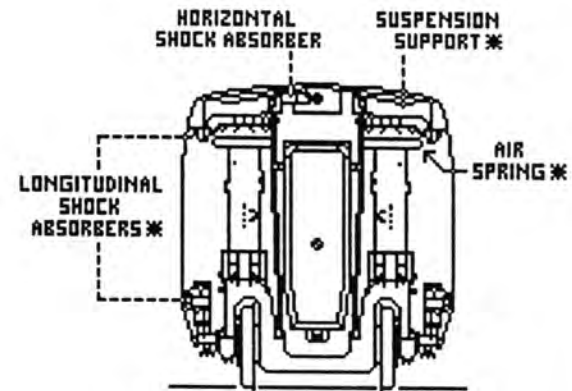

* = ONE SET EACH SIDE

FLOOR PLAN

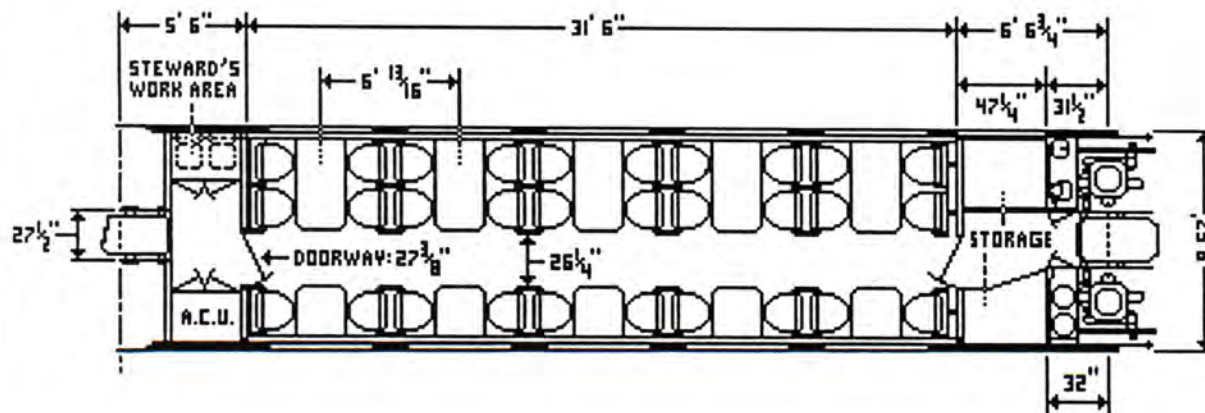

TABLE SEATS: 30

TALGO SLEEPING CAR

Equipment Code:

125 MPH

Talgo

SIDE VIEW

ALL WINDOWS ARE EMERGENCY WINDOWS

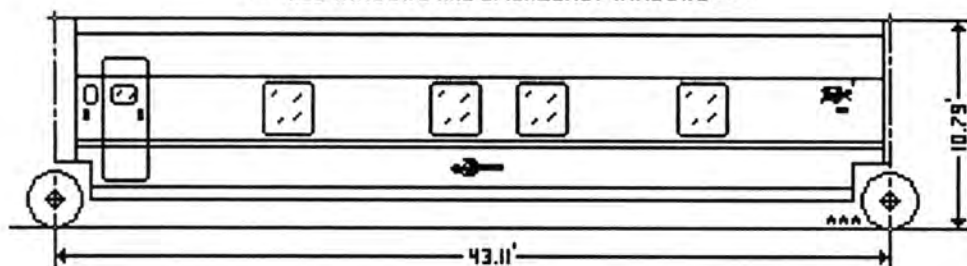

END VIEW

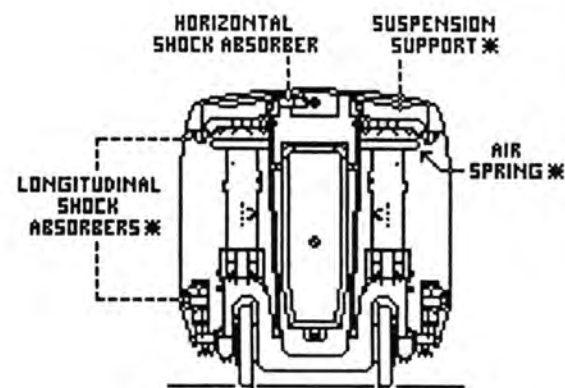

* = ONE SET EACH SIDE

FLOOR PLAN

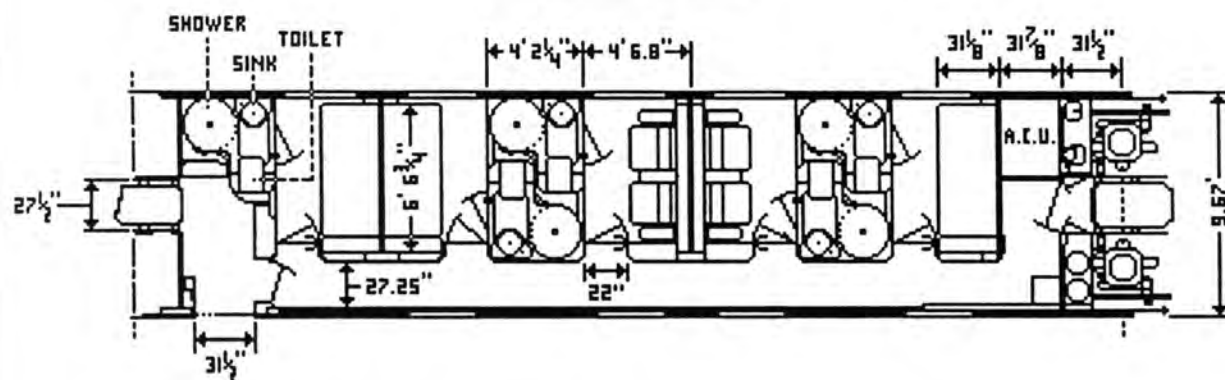

ROOMS: 5

TALGO SPECIAL ASSISTANCE COACH (2M SEATING)

Equipment Code:

125 MPH

Talgo

SIDE VIEW

+++ ALL WINDOWS ARE EMERGENCY WINDOWS +++

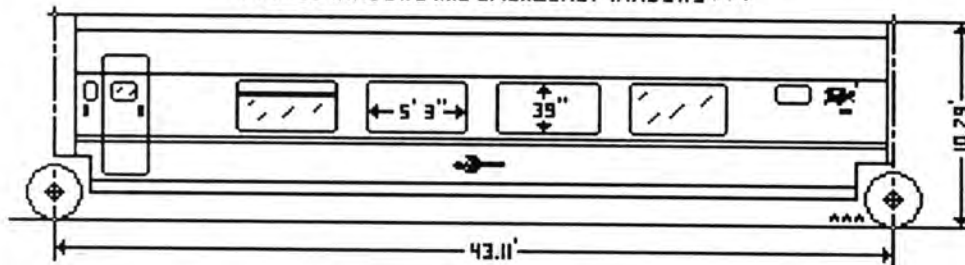

END VIEW

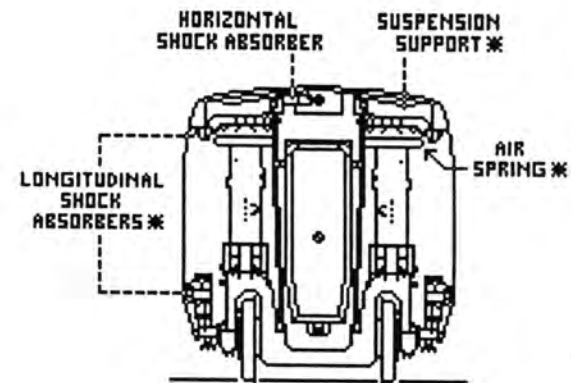

* = ONE SET EACH SIDE

FLOOR PLAN

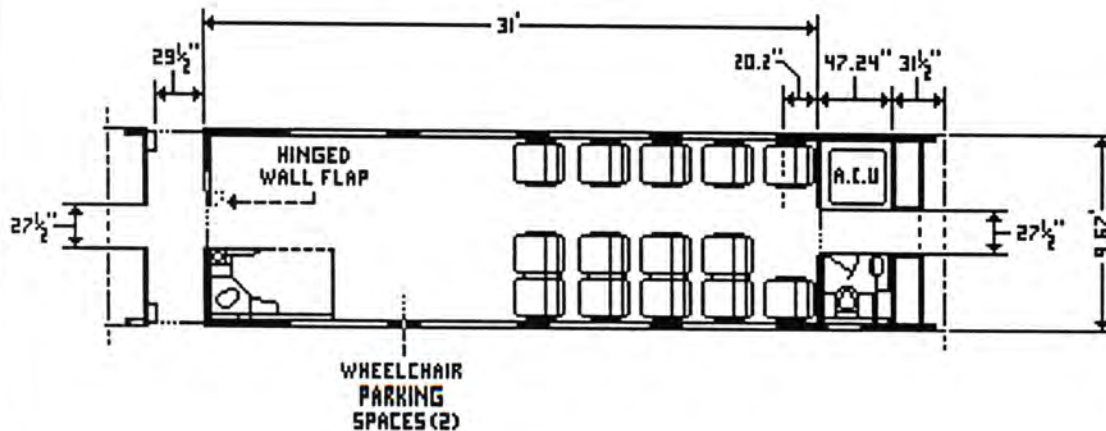

SEATS: 14

TALGO SPECIAL ASSISTANCE COACH (2/1 SEATING)

Equipment Code:

125 MPH

Talgo

SIDE VIEW

ALL WINDOWS ARE EMERGENCY WINDOWS

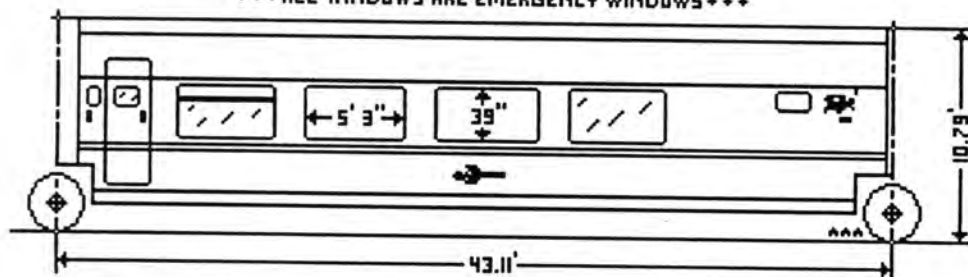

END VIEW

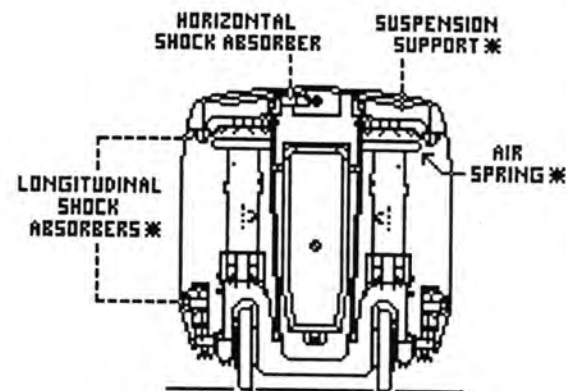

* = ONE SET EACH SIDE

FLOOR PLAN

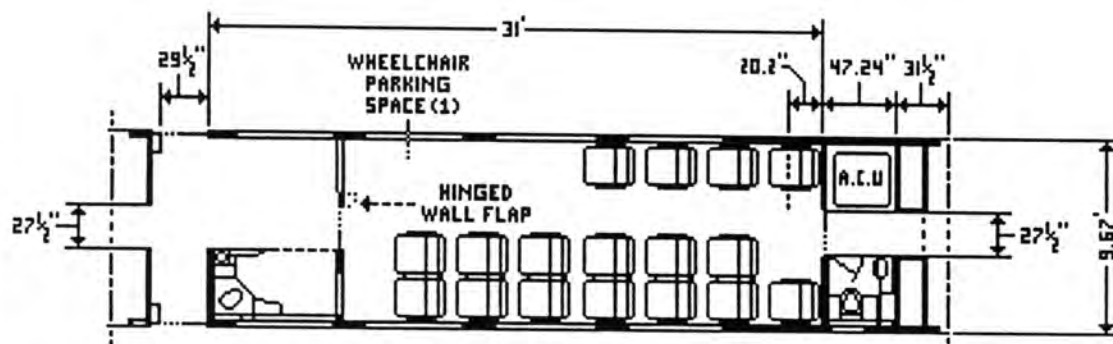

SEATS: 17